

**Relatives of
Joseph Sears
(1778-1851)**

Compiled by Leslie Sears
Moore, USA
19th November 2020

Compiled by Leslie Sears

Copyright 2020 by Leslie Sears

All rights reserved. No part of this publication may be reproduced or transmitted in any form or by any means, electronic or mechanical, including photocopy, recording or any information storage on retrieval system, without permission in writing from the copyright owner.

A comparatively modest present,
but the good ones which I can give.

"Only who knows his past has a future."
Wilhelm von Humboldt (1767-1835)

Foreword

This book contains the facts, who, where, when, but not the story of our family. If you can add to our history or have an anecdote to tell, then please share it and help make our story come alive. Even little things, like your cousin the fisherman who didn't eat fish, will make our story more personal. If you can add to our story, please contact me! I hope to have at least a photo of everyone who is here. It is amazing how often there is a close resemblance for relatives separated by generations.

Leslie Sears
Moore, USA
19th November 2020

Contents

Introduction.....	9
Family of the Starting Person	11
Joseph Sears and Lucy Smith	11
Related 1 Step Removed	13
Parents.....	13
Joshua Sears and Sarah Blackmore	13
Siblings	17
David Sears	17
Joshua Sears	18
Daniel Sears and Edy Bosworth.....	19
Children.....	23
Daniel Sears and M Ross.....	23
Joshua Sears and Clarissa Bosworth	24
Edmund Sears and Ellen Bacon	27
Related 2 Steps Removed.....	39
Grandparents	39
Joshua Sears and Rebecca Mayo	39
Uncles/aunts	45
Elkanah Sears and Ruth White	45
Betsy Sears and Samuel Hitchcock	48
Paul Sears.....	49
Paul Sears and Lydia Knight.....	49
Paul Sears and Elizabeth Slawter	50
Simeon Sears and Sarah --Sears.....	52
Sarah Sears and Samuel Hitchcock.....	54
Hannah Sears and Elisha Sheldon.....	56
1st Cousins	59
Isaac Sears and Grace Daniels	59
Willard Sears	65
Willard Sears and Rhoda Bailey	67
Willard Sears and Betsy Clark	68
Ruth Sears and Joshua Bailey	72
Rachel Sears and Nathaniel Bailey	74
Benjamin Sears and Ann Bigelow	75
Elizabeth Sears and Lemuel Sizer	80
Nancy Sears and Cyrenus Handy.....	81
Paul Sears and Rachel Granger	84
Simeon Sears	91
Simeon Sears and Polly Hurlburt	92
Simeon Sears and Louisa Spencer	93
Esther Sears and Gillette Hawley.....	97
Joseph Sears and Sarah Pitts.....	98
Rhoda Sears.....	101
Rhoda Sears and Ephraim Fitch	102
Rhoda Sears and Joseph Fitch.....	103
Daniel Sears and Cynthia Scott	104
Laura Sears and William Curtiss	106
Ebenezer Hitchcock and Elizabeth Everett.....	109
Reuben Hitchcock and Electa Spaulding.....	110
Jerusha Hitchcock and David Rhodes.....	111
Nephews/nieces.....	113
Sarah Sears and Wheeler.....	113
Mary Sears.....	113
Mary Sears and Isaac Gamble	114
Mary Sears and Immar Hubbard.....	115

Contents

Sarah Sears and Baldwin.....	116
Jason Sears and Martha Anthony	117
Henry Sears and Mary Wheeler.....	120
Grandchildren	123
Edmund Sears and Jane Sage	123
Francis Sears and Mary Sparhawk.....	127
Edmund Sears and Helen Swazey	132
Bibliography	135
Index of Places	139
Index of Individuals	147

Introduction{ TC "Introduction" \f C}

The following pages list data for all known family members as of 19th November 2020.

Each immediate family is presented in their own section that contains a graphical family tree as well as a description with information about each referenced person and their children. The child section provides information about the children of the preceding couple. When a child has offspring of their own this is presented in a separate family section for that child. In this case a '+' is used to denote that an individual will appear later in the book as a parent with his/her own children and there is a link to the appropriate family reference number. For children with partners but no offspring the partner data is given with the reference family. Roman numerals, followed by a period, are used to indicate the birth order.

In the chapter titled "Family of the Starting Person" the ancestors of Joseph Sears are presented in a kind of enhanced Pedigree Chart which displays the graphic representation of their direct-line ancestors and the children of the couple. This chapter contains information about the couple whose relatives are listed in the later chapters.

The chapter titled "Families of his Ancestors" provides details (as known as of the publication date) for the relatives of Joseph Sears. There is a chapter for each generation. Relatives are listed in the order of the nearness of their relationship.

Sources for the information provided are given in the footnotes.

This document reports the details of 291 individuals, of whom 140 are male and 150 are female. The sex of one individual is unknown. Of the 188 individuals with recorded birth and death dates, the average lifespan was 64.13 years. Of these, 94 males averaged 69.41 years, and 93 females averaged 59.48 years. The longest living male was Elijah Clark Sears (1805–1910), who died aged 105. The longest living female was Sophia Whitney Bennett (1883–1980), who died aged 97.

Family of the Starting Person{ TC "Family of the Starting Person" \f C}

Family of Joseph Sears and Lucy Smith{ TC "Joseph Sears and Lucy Smith" \i 3 \f C}

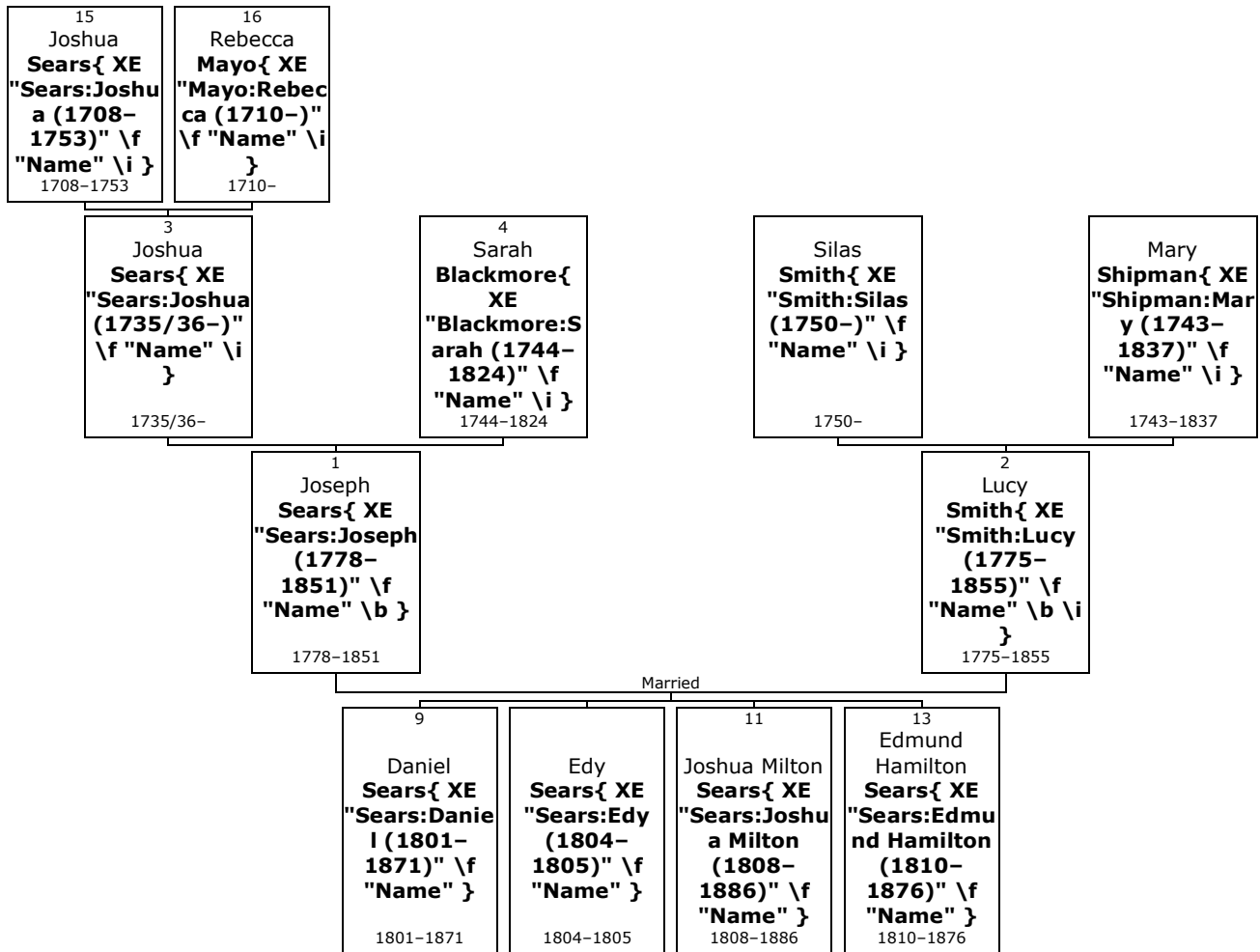

- Hon Joseph⁶ Sears**{ XE "Sears:Joseph (1778-1851)" \f "Name" \b } (Joshua⁵, Joshua⁴, Paul³, Paul², Richard¹) was born in 1778 in Sandisfield, Berkshire, Massachusetts, USA{ XE "USA, Massachusetts, Berkshire, Sandisfield:(42.1126° N, 73.1432° W):Sears, Joseph (1778-1851)" \f "Place" }.^[1] He was the son of Joshua Sears{ XE "Sears:Joshua (1735/36-)\" \f "Name" \i } (3) and Sarah Blackmore{ XE "Blackmore:Sarah (1744-1824)" \f "Name" \i } (4).

Joseph died in Sandisfield{ XE "USA, Massachusetts, Berkshire, Sandisfield:(42.1126° N, 73.1432° W):Sears, Joseph (1778-1851)" \f "Place" } on 8th September 1851, at the age of 73.^[1] He was buried in Sandisfield, Berkshire County{ XE "USA, Massachusetts, Berkshire County, Sandisfield:(42.1126° N, 73.1432° W):Sears, Joseph (1778-1851)" \f "Place" }.^[1]

!S P May No 539 p 228; Joseph Sears was a prominent man, and held various offices, Rep to State Leg., 1819, 1820, 1822. He died in a fit. !

Mayflower Index: No. 29,966 Joseph; spouse Lucy Smith; father Joshua

<https://www.wikitree.com/index.php?title=Sears-1726&action=edit>

¹ Ancestry.com, U.S., Find A Grave Index, 1600s-Current (Provo, UT, USA, Ancestry.com Operations, Inc., 2012), Ancestry.com.

* <http://familytreemaker.genealogy.com/users/m/u/l/Paul-D-Mullins/WEBSITE-0001/UHP-0300.html>
accessed 1 Jan 2020

2. He married **Lucy Smith**{ XE "Smith:Lucy (1775–1855)" \f "Name" \b \i }. They had four children: Daniel (1801–1871), Edy (1804–1805), Joshua (1808–1886) and Edmund (1810–1876).

Lucy was born in Connecticut{ XE "USA, Connecticut:(41.5735° N, 72.7383° W):Smith, Lucy (1775–1855)" \f "Place" } in 1775. She was the daughter of Silas Smith{ XE "Smith:Silas (1750–)" \f "Name" \i } and Mary Shipman{ XE "Shipman:Mary (1743–1837)" \f "Name" \i }.

Lucy reached 80 years of age and died on 4th October 1855.

Children of Joseph Sears and Lucy Smith:

- | | | | |
|---|----|---|--|
| + | 9 | m | I. Daniel⁵ Sears { XE "Sears:Daniel (1801–1871)" \f "Name" } was born in Sandisfield, Berkshire, Massachusetts,{ XE "USA, Massachusetts, Berkshire, Sandisfield:(42.1126° N, 73.1432° W):Sears, Daniel (1801–1871)" \f "Place" } on 13 th April 1801. ^[2] He died in 1871 at the age of 69. |
| | | f | II. Edy Sears { XE "Sears:Edy (1804–1805)" \f "Name" \b } was born in Sandisfield{ XE "USA, Massachusetts, Berkshire, Sandisfield:(42.1126° N, 73.1432° W):Sears, Edy (1804–1805)" \f "Place" } on 11 th May 1804. She died on 1 st May 1805. |
| + | 11 | m | III. Joshua Milton Sears { XE "Sears:Joshua Milton (1808–1886)" \f "Name" } was born in Sandisfield{ XE "USA, Massachusetts, Berkshire, Sandisfield:(42.1126° N, 73.1432° W):Sears, Joshua Milton (1808–1886)" \f "Place" } on 19 th September 1808. ^[1, 3, 4] He died in Sandisfield{ XE "USA, Massachusetts, Berkshire, Sandisfield:(42.1126° N, 73.1432° W):Sears, Joshua Milton (1808–1886)" \f "Place" } on 24 th August 1886, at the age of 77. ^[1] |
| + | 13 | m | IV. Edmund Hamilton Sears { XE "Sears:Edmund Hamilton (1810–1876)" \f "Name" } was born in Sandisfield{ XE "USA, Massachusetts, Berkshire, Sandisfield:(42.1126° N, 73.1432° W):Sears, Edmund Hamilton (1810–1876)" \f "Place" } on 6 th April 1810. ^[1, 5] He died in Weston, Middlesex,{ XE "USA, Massachusetts, Middlesex, Weston:(42.3668° N, 71.3031° W):Sears, Edmund Hamilton (1810–1876)" \f "Place" } on 16 th January 1876, at the age of 65. ^[1] |

² Ancestry.com, Massachusetts, Town and Vital Records, 1620-1988 (Provo, UT, USA, Ancestry.com Operations, Inc., 2011), Ancestry.com.

³ Ancestry.com and The Church of Jesus Christ of Latter-day Saints, 1880 United States Federal Census (Provo, UT, USA, Ancestry.com Operations Inc, 2010), Ancestry.com, Year: 1880; Census Place: Sandisfield, Berkshire, Massachusetts; Roll: 520; Family History Film: 1254520; Page: 580C; Enumeration District: 038.

⁴ Ancestry.com, 1850 United States Federal Census (Provo, UT, USA, Ancestry.com Operations, Inc., 2009), Ancestry.com, Year: 1850; Census Place: Sandisfield, Berkshire, Massachusetts; Roll: M432_306; Page: 300A; Image: 597.

⁵ Ancestry.com, U.S. Passport Applications, 1795-1925 (Provo, UT, USA, Ancestry.com Operations, Inc., 2007), Ancestry.com, National Archives and Records Administration (NARA); Washington D.C.; NARA Series: Passport Applications, January 2, 1906 - March 31, 1925; Roll #: 1902; Volume #: Roll 1902 - Certificates: 144600-144975, 12 Apr 1922-13 Apr 1922.

Related 1 Step Removed{ TC "Related 1 Step Removed" \f C}

Parents{ TC "Parents" \I 2 \f C}

Family of Joshua Sears and Sarah Blackmore{ TC "Joshua Sears and Sarah Blackmore" \I 3 \f C}

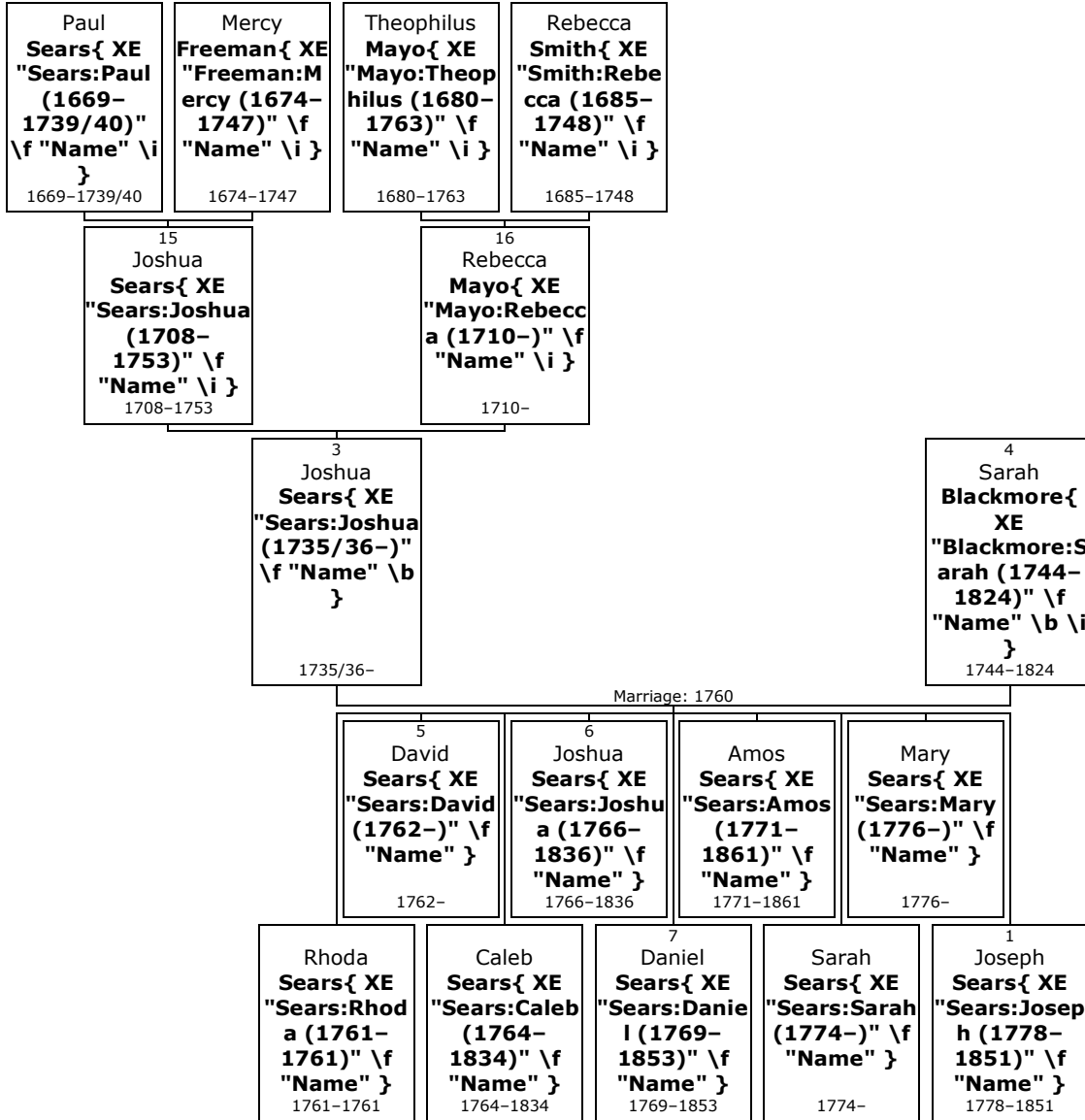

3. **Joshua³ Sears{ XE "Sears:Joshua (1735/36-)" \f "Name" \b } (Joshua²)** was born on 14th February 1735/36, in Harwich, Barnstable, Massachusetts, USA{ XE "USA, Massachusetts, Barnstable, Harwich:(41.6862° N, 70.0758° W):Sears, Joshua (1735/36-)" \f "Place" }.^[6] He was the son of Joshua Sears{ XE "Sears:Joshua (1708-1753)" \f "Name" \i } (15) and Rebecca Mayo{ XE "Mayo:Rebecca (1710-)" \f "Name" \i } (16).

Joshua was christened on 24th June 1739. He died in Sandisfield, Berkshire{ XE "USA, Massachusetts, Berkshire, Sandisfield:(42.1126° N, 73.1432° W):Sears, Joshua (1735/36-)" \f "Place" }.

!Harwich VR p. 67 [Vol I p. 228]b.

!

⁶ Ancestry.com, Massachusetts, Town and Vital Records, 1620-1988 (Provo, UT, USA, Ancestry.com Operations, Inc., 2011), Ancestry.com, Record for Joshua Sears. <http://search.ancestry.com/cgi-bin/sse.dll?db=2495&h=7520739&indiv=try>. [Source citation includes one media item]

!S.P. May No 199 p.137/8 Joshua Sears removed to Middletown, CT, with his parents in 1746, and later to Sandisfield, MA, where he was one of the earliest settlers. ! "He enlisted in the old French war, and joined the expedition commanded by Abercrombie, against Ticonderoga and Crown Point, then in possession of the French under Montcalm. ! "Abercrombie without waiting for his artillery, made a brave but imprudent assault upon the fortress of the former place. The result was disastrous. His troops were mowed down in ranks before the guns of the fort. Sears used to describe the horrors of the carnage, and his own wonderful preservation. Three times we marched up in front of those guns, and each time, the men on my right, and my left, were cut down, and I was left standing alone. The hardships of the campaign were great, but he survived them, and returned to Sandisfield, but died in middle life in consequence of them.

!

!Mayflower Index: No. 29,970 Joshua; spouse Sarah Blackmore; father Joshua

!

!SEARS, Joshua Clam River Cem Sandisfield MA 56

Abstract of Graves of Revolutionary Patriots, Vol.4, p. -Serial: 11999; Volume: 8

!

!Tyringham VR Joshua Sears and Sarah Blackman[?] m. C.R.

*1790 Census Sandisfield, MA 2 males>16, 1 male<16 (b. aft 1774), 2 females who is this Joshua Sears in Sandisfield? Maybe his father?

This Joshua b. 1735 of 9 kids, those remaining in 1790 could be sons Amos (1771), Joseph (1778) and dau Sarah (1774) w/ wife Sarah

4. Joshua married **Sarah Blackmore**{ XE "Blackmore:Sarah (1744-1824)" \f "Name" \b \i } on Friday, 28th November 1760, in Tyringham{ XE "USA, Massachusetts, Berkshire, Tyringham:(42.2459° N, 73.2037° W):Sears, Joshua (1735/36-)" \f "Place" }.^[6] They had nine children: Rhoda (1761-1761), David (1762-), Caleb (1764-1834), Joshua (1766-1836), Daniel (1769-1853), Amos (1771-1861), Sarah (1774-), Mary (1776-) and Joseph (1778-1851).

Sarah was born in Newburyport, Essex,{ XE "USA, Massachusetts, Essex, Newburyport:(42.8126° N, 70.8773° W):Blackmore, Sarah (1744-1824)" \f "Place" } in 1744. She reached 80 years of age and died in Sandwich, Barnstable,{ XE "USA, Massachusetts, Barnstable, Sandwich:(41.759° N, 70.4939° W):Blackmore, Sarah (1744-1824)" \f "Place" } on 21st August 1824.

Children of Joshua Sears and Sarah Blackmore:

- | | |
|-----|---|
| f | I. Rhoda⁴ Sears { XE "Sears:Rhoda (1761-1761)" \f "Name" \b } was born in Sandisfield{ XE "USA, Massachusetts, Berkshire, Sandisfield:(42.1126° N, 73.1432° W):Sears, Rhoda (1761-1761)" \f "Place" } on 1 st October 1761. She died on 19 th November 1761. |
| + 5 | m II. David Sears { XE "Sears:David (1762-)" \f "Name" } was born in Sandisfield{ XE "USA, Massachusetts, Berkshire, Sandisfield:(42.1126° N, 73.1432° W):Sears, David (1762-)" \f "Place" } on 2 nd October 1762. ^[7] |
| | m III. Caleb Sears { XE "Sears:Caleb (1764-1834)" \f "Name" \b } was born in Sandisfield{ XE "USA, Massachusetts, Berkshire, Sandisfield:(42.1126° N, 73.1432° W):Sears, Caleb (1764-1834)" \f "Place" } on 4 th November 1764. ^[7] He died in 1834 at the age of 69. |
| + 6 | m IV. Joshua Sears { XE "Sears:Joshua (1766-1836)" \f "Name" } was born in Sandisfield{ XE "USA, Massachusetts, Berkshire, Sandisfield:(42.1126° N, 73.1432° W):Sears, Joshua (1766-1836)" \f "Place" } on 7 th November 1766. ^[6-8] He died in 1836 at the age of 69. |
| + 7 | m V. Daniel Sears { XE "Sears:Daniel (1769-1853)" \f "Name" } was born in Sandisfield{ XE "USA, Massachusetts, Berkshire, Sandisfield:(42.1126° N, 73.1432° W):Sears, Daniel (1769-1853)" \f "Place" } on 2 nd February 1769. ^[7, 9] He died in Sandisfield{ XE "USA, Massachusetts, Berkshire, Sandisfield:(42.1126° N, 73.1432° W):Sears, Daniel (1769-1853)" \f "Place" } on 30 th May 1853, at the age of 84. ^[7, 8] |

⁷ Ancestry.com, Massachusetts, Town and Vital Records, 1620-1988 (Provo, UT, USA, Ancestry.com Operations, Inc., 2011), Ancestry.com.

⁸ Ancestry.com, U.S., Find A Grave Index, 1600s-Current (Provo, UT, USA, Ancestry.com Operations, Inc., 2012), Ancestry.com.

⁹ Ancestry.com, 1850 United States Federal Census (Provo, UT, USA, Ancestry.com Operations, Inc., 2009), Ancestry.com, Year: 1850; Census Place: Sandisfield, Berkshire, Massachusetts; Roll: M432_306; Page: 289B; Image: 576.

- m VI. **Amos Sears**{ XE "Sears:Amos (1771-1861)" \f "Name" \b } was born in Sandisfield{ XE "USA, Massachusetts, Berkshire, Sandisfield:(42.1126° N, 73.1432° W):Sears, Amos (1771-1861)" \f "Place" } on 12th January 1771. He died on 25th December 1861, at the age of 90.
- f VII. **Sarah Sears**{ XE "Sears:Sarah (1774-)" \f "Name" \b } was born in Sandisfield{ XE "USA, Massachusetts, Berkshire, Sandisfield:(42.1126° N, 73.1432° W):Sears, Sarah (1774-)" \f "Place" } on 1st April 1774.
- f VIII. **Mary Sears**{ XE "Sears:Mary (1776-)" \f "Name" \b } was born in Sandisfield{ XE "USA, Massachusetts, Berkshire, Sandisfield:(42.1126° N, 73.1432° W):Sears, Mary (1776-)" \f "Place" } on 3rd October 1776.
- + 1 m IX. **Joseph Sears**{ XE "Sears:Joseph (1778-1851)" \f "Name" } was born in Sandisfield{ XE "USA, Massachusetts, Berkshire, Sandisfield:(42.1126° N, 73.1432° W):Sears, Joseph (1778-1851)" \f "Place" } in 1778.^[8] He died in Sandisfield{ XE "USA, Massachusetts, Berkshire, Sandisfield:(42.1126° N, 73.1432° W):Sears, Joseph (1778-1851)" \f "Place" } on 8th September 1851, at the age of 73.^[8]

Siblings{ TC "Siblings" \I 2 \f C}

David Sears{ TC "David Sears" \I 3 \f C}

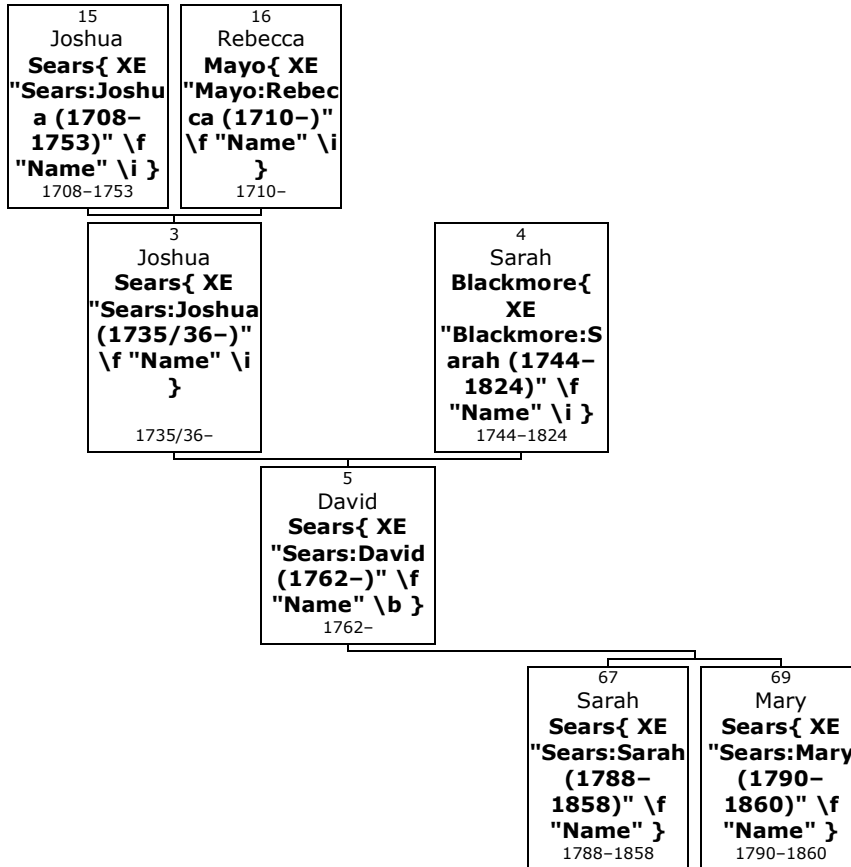

5. **David⁴ Sears**{ XE "Sears:David (1762-)" \f "Name" \b } (*Sarah³ Blackmore*) was born on Saturday, 2nd October 1762, in Sandisfield, Berkshire, Massachusetts, USA{ XE "USA, Massachusetts, Berkshire, Sandisfield:(42.1126° N, 73.1432° W):Sears, David (1762-)" \f "Place" }.^[10] He was the son of Joshua Sears{ XE "Sears:Joshua (1735/36-)" \f "Name" \i } (3) and Sarah Blackmore{ XE "Blackmore:Sarah (1744-1824)" \f "Name" \i } (4).

!S.P. May p.227, No 532 David Sears of Sandisfield, laborer, age 18, 5 ft. 9 in. height, light complexion, brown hair, enlisted in Capt Robins' Co., in Col Ashby's Regt, 2 Jul 1780, and was discharged 5 Jan 1781, having served 6 mos. 7 days, travel 75 miles from home, wages £12.9.4; he was in Capt John Barrows' Co., Col Caleb Hyde's Regt, and served at Stillwater, NY, 20-28 Oct 17__; 9 days, 60 miles travel. Rev EH Sears says:"He enlisted in the war of the Revolution, was in Washington's Army, and passed through the trying scenes of the New Jersey Campaign."

<https://www.wikitree.com/wiki/Sears-4459>

Daughters of David Sears:

- + 67 f I. **Sarah⁵ Sears**{ XE "Sears:Sarah (1788-1858)" \f "Name" } was born in Sandisfield{ XE "USA, Massachusetts, Berkshire, Sandisfield:(42.1126° N, 73.1432° W):Sears, Sarah (1788-1858)" \f "Place" } in 1788. She died in 1858 at the age of 70.
- + 69 f II. **Mary Sears**{ XE "Sears:Mary (1790-1860)" \f "Name" } was born in Sandisfield{ XE "USA, Massachusetts, Berkshire, Sandisfield:(42.1126° N, 73.1432° W):Sears, Mary (1790-1860)" \f "Place" } in 1790. She died in 1860 at the age of 70.

¹⁰ Ancestry.com, Massachusetts, Town and Vital Records, 1620-1988 (Provo, UT, USA, Ancestry.com Operations, Inc., 2011), Ancestry.com.
[Source citation includes one media item]

Joshua Sears{ TC "Joshua Sears" \I 3 \f C}

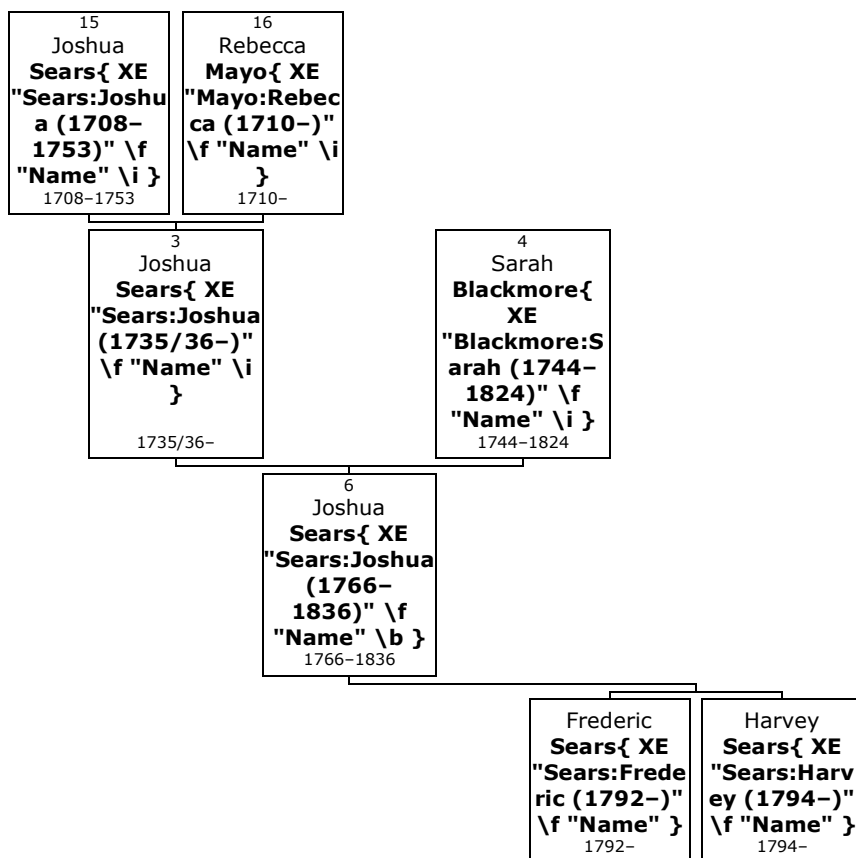

6. **Joshua⁴ Sears**{ XE "Sears:Joshua (1766-1836)" \f "Name" \b } (*Sarah³ Blackmore*) was born on Friday, 7th November 1766, in Sandisfield, Berkshire, Massachusetts, USA{ XE "USA, Massachusetts, Berkshire, Sandisfield:(42.1126° N, 73.1432° W):Sears, Joshua (1766-1836)" \f "Place" }.^[11, 12, 13-14] He was the son of Joshua Sears{ XE "Sears:Joshua (1735/36-)" \f "Name" \i } (3) and Sarah Blackmore{ XE "Blackmore:Sarah (1744-1824)" \f "Name" \i } (4).

Joshua died in 1836 at the age of 69. He was buried in Sandisfield, Berkshire County{ XE "USA, Massachusetts, Berkshire County, Sandisfield:(42.1126° N, 73.1432° W):Sears, Joshua (1766-1836)" \f "Place" }.^[12]

!S P May p.227 (No 534) Joshua Sears served in Capt Jere. Hickok's Co, Lt Col Sears' Regt, 6 Aug to 8 Nov 1781, 3 mos 7 days. He removed to NY state.

<https://www.wikitree.com/wiki/Sears-4461>

Find A Grave Memorial# 71017079 Birth: Nov. 7, 1766 Death: unknown Burial: Sandisfield Center Cemetery Sandisfield Berkshire County Massachusetts, USA Created by: Mark Wing Record added: Jun

¹¹ Ancestry.com, Massachusetts, Town and Vital Records, 1620-1988 (Provo, UT, USA, Ancestry.com Operations, Inc., 2011), Ancestry.com.

[Source citation includes one media item]

¹² Ancestry.com, U.S., Find A Grave Index, 1600s-Current (Provo, UT, USA, Ancestry.com Operations, Inc., 2012), Ancestry.com.

¹³ Ancestry.com, Massachusetts, Town and Vital Records, 1620-1988 (Provo, UT, USA, Ancestry.com Operations, Inc., 2011), Ancestry.com, Record for Joshua Sears. <http://search.ancestry.com/cgi-bin/sse.dll?db=2495&h=7520739&indiv=try>. [Source citation includes one media item]

¹⁴ Ancestry.com, 1790 United States Federal Census (Provo, UT, USA, Ancestry.com Operations, Inc., 2010), Ancestry.com, Year: 1790; Census Place: Sandisfield, Berkshire, Massachusetts; Series: M637; Roll: 4; Page: 593; Image: 643; Family History Library Film: 0568144. Record for Joshua Sears. <http://search.ancestry.com/cgi-bin/sse.dll?db=5058&h=44251&indiv=try>. [Source citation includes one media item]

08, 2011 "In Memory of SARAH JEWELL JOSHUA SEARS _____ Oliver..." If this is his tombstone what is his connection to Sarah Jewell and the name Oliver

More facts and events for Joshua Sears:

Residence: 1790 Sandisfield, Berkshire{ XE "USA, Massachusetts, Berkshire, Sandisfield:(42.1126° N, 73.1432° W):Sears, Joshua (1766–1836)" \f "Place" }^[14]

Sons of Joshua Sears:

- m I. **Frederic⁵ Sears**{ XE "Sears:Frederic (1792–)" \f "Name" \b } was born in 1792.
- m II. **Harvey Sears**{ XE "Sears:Harvey (1794–)" \f "Name" \b } was born in 1794.

Family of Daniel Sears and Edy Bosworth{ TC "Daniel Sears and Edy Bosworth" \I 3 \f C}

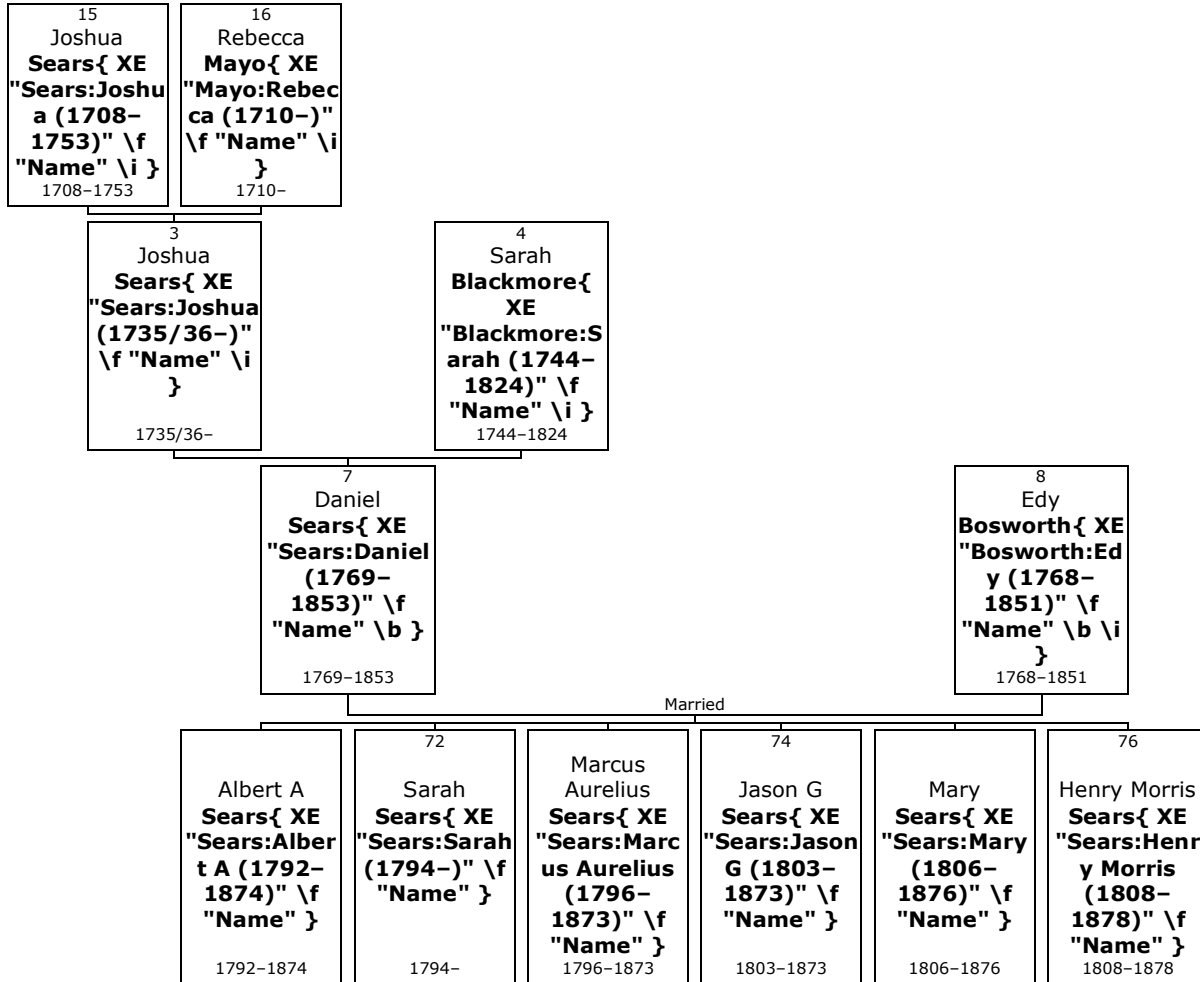

7. **Capt Daniel⁴ Sears**{ XE "Sears:Daniel (1769–1853)" \f "Name" \b } (*Sarah³ Blackmore*) was born on Thursday, 2nd February 1769, in Sandisfield, Berkshire, Massachusetts, USA{ XE "USA, Massachusetts, Berkshire, Sandisfield:(42.1126° N, 73.1432° W):Sears, Daniel (1769–1853)" \f "Place" }^[15, 16, 17-18] He

¹⁵ Ancestry.com, 1850 United States Federal Census (Provo, UT, USA, Ancestry.com Operations, Inc., 2009), Ancestry.com, Year: 1850; Census Place: Sandisfield, Berkshire, Massachusetts; Roll: M432_306; Page: 289B; Image: 576. [Source citation includes one media item]

¹⁶ Ancestry.com, Massachusetts, Town and Vital Records, 1620-1988 (Provo, UT, USA, Ancestry.com Operations, Inc., 2011), Ancestry.com. [Source citation includes one media item]

¹⁷ Ancestry.com, U.S., Find A Grave Index, 1600s-Current (Provo, UT, USA, Ancestry.com Operations, Inc., 2012), Ancestry.com.

was the son of Joshua Sears{ XE "Sears:Joshua (1735/36-)" \f "Name" \i } (3) and Sarah Blackmore{ XE "Blackmore:Sarah (1744-1824)" \f "Name" \i } (4).

Daniel died in Sandisfield{ XE "USA, Massachusetts, Berkshire, Sandisfield:(42.1126° N, 73.1432° W):Sears, Daniel (1769-1853)" \f "Place" } on 30th May 1853, at the age of 84.^[16, 17] He was buried in Sandisfield{ XE "USA, Massachusetts, Berkshire, Sandisfield:(42.1126° N, 73.1432° W):Sears, Daniel (1769-1853)" \f "Place" }.^[17]

!S P May p.228, No 535, Daniel Sears is styled "Captain" in town records. He lived to a great age, held many offices of trust, and died venerable for character and years

!J W Sears archives: d. place

<https://www.wikitree.com/wiki/Sears-4462>

<https://www.ancestry.com/family-tree/person/tree/159885078/person/202093626138/facts> tree of Kathryn Hartley
Name Daniel Sears Birth Year abt 1769 Event Death Death Date 30 May 1853 Death Place Sandisfield Age at Death 84 Newspaper The Hartford Times Publication Date 11 Jun 1853 Publication Place Connecticut, USA Call Number 486551

More facts and events for Daniel Sears:

Residence: 1850 Sandisfield{ XE "USA, Massachusetts, Berkshire, Sandisfield:(42.1126° N, 73.1432° W):Sears, Daniel (1769-1853)" \f "Place" }.^[15]

8. He married **Edy Bosworth**{ XE "Bosworth:Edy (1768-1851)" \f "Name" \b \i }.^[17, 18] They had six children: Albert (1792-1874), Sarah (1794-), Marcus (1796-1873), Jason (1803-1873), Mary (1806-1876) and Henry (1808-1878).

Edy was born in Sandisfield{ XE "USA, Massachusetts, Berkshire, Sandisfield:(42.1126° N, 73.1432° W):Bosworth, Edy (1768-1851)" \f "Place" } in 1768.^[17] She reached 83 years of age and died in USA{ XE "USA: :Bosworth, Edy (1768-1851)" \f "Place" } on 18th August 1851.^[17] Edy was buried in Sandisfield, Berkshire County, Massachusetts, USA{ XE "USA, Massachusetts, Berkshire County, Sandisfield:(42.1126° N, 73.1432° W):Bosworth, Edy (1768-1851)" \f "Place" }.^[17]

!d. "Lung Fever"

Children of Daniel Sears and Edy Bosworth:

- | | | |
|------|---|--|
| | m | I. Albert A^s Sears { XE "Sears:Albert A (1792-1874)" \f "Name" \b } was born in Sandisfield, Berkshire,{ XE "USA, Massachusetts, Berkshire, Sandisfield:(42.1126° N, 73.1432° W):Sears, Albert A (1792-1874)" \f "Place" } on 10 th April 1792. ^[17] He died in Chester Center, Chester, Geauga, Ohio,{ XE "USA, Ohio, Geauga, Chester, Chester Center: :Sears, Albert A (1792-1874)" \f "Place" } on 18 th July 1874, at the age of 82. ^[17] Albert A was buried in Chesterland, Geauga County{ XE "USA, Ohio, Geauga County, Chesterland:(41.5223° N, 81.3379° W):Sears, Albert A (1792-1874)" \f "Place" }. ^[17] |
| + 72 | f | II. Sarah Sears { XE "Sears:Sarah (1794-)" \f "Name" } was born in Sandisfield{ XE "USA, Massachusetts, Berkshire, Sandisfield:(42.1126° N, 73.1432° W):Sears, Sarah (1794-)" \f "Place" } on 12 th January 1794. |
| | m | III. Marcus Aurelius Sears { XE "Sears:Marcus Aurelius (1796-1873)" \f "Name" \b } was born in Sandisfield{ XE "USA, Massachusetts, Berkshire, Sandisfield:(42.1126° N, 73.1432° W):Sears, Marcus Aurelius (1796-1873)" \f "Place" } on 11 th July 1796. ^[16, 17] He died in Geauga, Ohio,{ XE "USA, Ohio, Geauga:(41.4988° N, 81.1725° W):Sears, Marcus Aurelius (1796-1873)" \f "Place" } on 30 th July 1873, at the age of 77. ^[17] Marcus Aurelius was buried in Chesterland, Geauga County{ XE "USA, Ohio, Geauga County, Chesterland:(41.5223° N, 81.3379° W):Sears, Marcus Aurelius (1796-1873)" \f "Place" }. ^[17] |
| + 74 | m | IV. Jason G Sears { XE "Sears:Jason G (1803-1873)" \f "Name" } was born in Sandisfield{ XE "USA, Massachusetts, Berkshire, Sandisfield:(42.1126° N, 73.1432° W):Sears, Jason |

¹⁸ Ancestry.com, Massachusetts, Town and Vital Records, 1620-1988 (Provo, UT, USA, Ancestry.com Operations, Inc., 2011), Ancestry.com, Record for Henry Morris Sears. <http://search.ancestry.com/cgi-bin/sse.dll?db=2495&h=4816287&indiv=try>. [Source citation includes one media item]

G (1803–1873)" \f "Place" } on 28th February 1803.^[16, 17, 19, 20] He died in Clinton, Greene, Alabama,{ XE "USA, Alabama, Greene, Clinton:(32.9136° N, 87.9925° W):Sears, Jason G (1803–1873)" \f "Place" } on 25th January 1873, at the age of 69.^[17]

f V. **Mary Sears**{ XE "Sears:Mary (1806–1876)" \f "Name" \b } was born in Sandisfield{ XE "USA, Massachusetts, Berkshire, Sandisfield:(42.1126° N, 73.1432° W):Sears, Mary (1806–1876)" \f "Place" } on 29th March 1806. She died in 1876 at the age of 69.

+ 76 m VI. **Henry Morris Sears**{ XE "Sears:Henry Morris (1808–1878)" \f "Name" } was born in Sandisfield{ XE "USA, Massachusetts, Berkshire, Sandisfield:(42.1126° N, 73.1432° W):Sears, Henry Morris (1808–1878)" \f "Place" } on 10th March 1808.^[16, 18, 21, 22–23] He died in 1878 at the age of 69.

¹⁹ Ancestry.com, 1870 United States Federal Census (Provo, UT, USA, Ancestry.com Operations, Inc., 2009), Ancestry.com, Year: 1870; Census Place: Clinton, Greene, Alabama; Roll: M593_17; Page: 631A; Image: 370770; Family History Library Film: 545516.

²⁰ Ancestry.com, 1850 United States Federal Census (Provo, UT, USA, Ancestry.com Operations, Inc., 2009), Ancestry.com, Year: 1850; Census Place: Clinton, Greene, Alabama; Roll: M432_6; Page: 270A; Image: 58.

²¹ Ancestry.com, 1860 United States Federal Census (Provo, UT, USA, Ancestry.com Operations, Inc., 2009), Ancestry.com, Year: 1860; Census Place: Sandisfield, Berkshire, Massachusetts; Roll: M653_487; Page: 745; Family History Library Film: 803487.

²² Ancestry.com and The Church of Jesus Christ of Latter-day Saints, 1880 United States Federal Census (Provo, UT, USA, Ancestry.com Operations Inc, 2010), Ancestry.com, Year: 1880; Census Place: Veteran, Chemung, New York; Roll: 817; Page: 590C; Enumeration District: 088. Record for Sarah E. Sears.
<http://search.ancestry.com/cgi-bin/sse.dll?db=6742&h=1460947&indiv=try>.

²³ Ancestry.com, New York, State Census, 1865 (Provo, UT, USA, Ancestry.com Operations, Inc., 2014), Ancestry.com, Record for Henry M Sears. <http://search.ancestry.com/cgi-bin/sse.dll?db=7218&h=1084737&indiv=try>.

Children{ TC "Children" \I 2 \f C}

Family of Daniel Sears and M Ross{ TC "Daniel Sears and M Ross" \I 3 \f C}

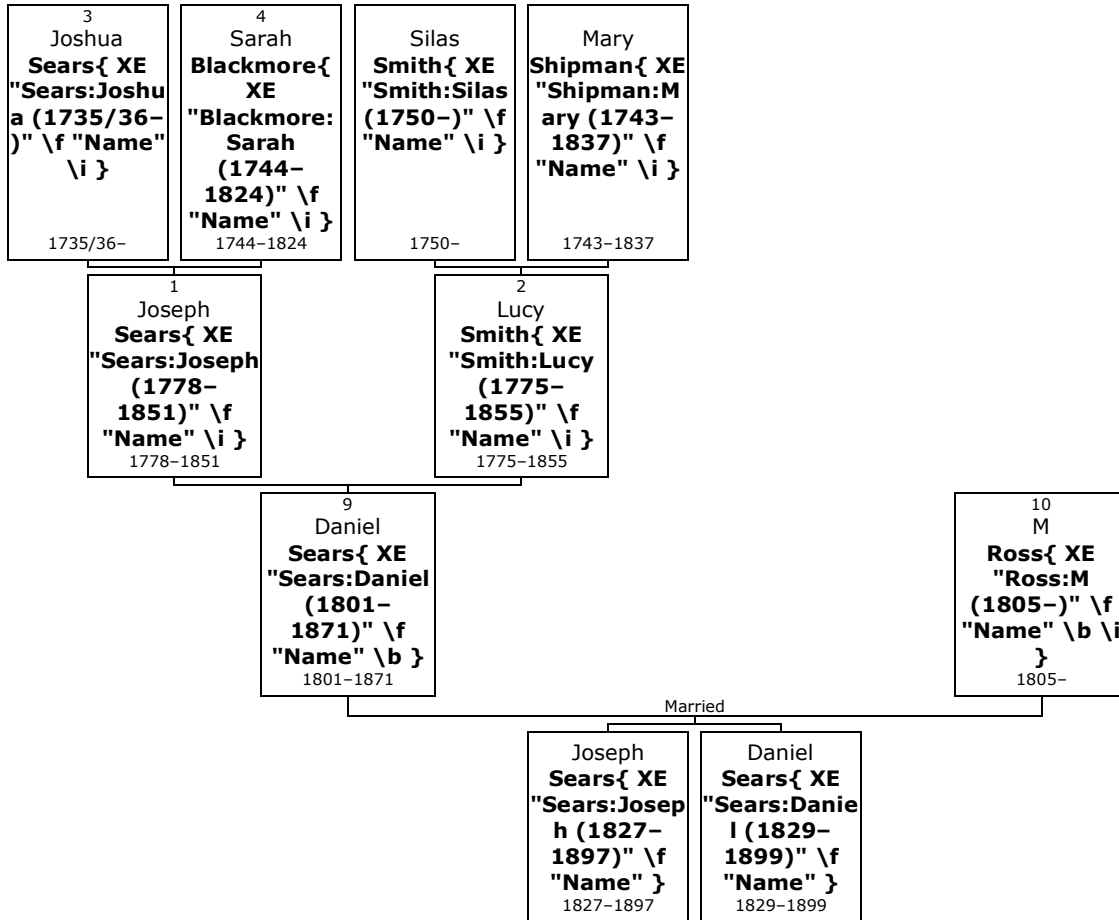

9. **Rev Daniel⁵ Sears**{ XE "Sears:Daniel (1801–1871)" \f "Name" \b } (*Hon Joseph⁴, Sarah³ Blackmore*) was born on Monday, 13th April 1801, in Sandisfield, Berkshire, Massachusetts, USA{ XE "USA, Massachusetts, Berkshire, Sandisfield:(42.1126° N, 73.1432° W):Sears, Daniel (1801–1871)" \f "Place" }.^[24] He was the son of Joseph Sears{ XE "Sears:Joseph (1778–1851)" \f "Name" \i } (1) and Lucy Smith{ XE "Smith:Lucy (1775–1855)" \f "Name" \i } (2).

Daniel died in 1871 at the age of 69.

!S P May No 1242 p.368 Daniel Sears was a Methodist clergyman, and removed to Wachita, LA

<https://www.wikitree.com/wiki/Sears-5168>

10. He married **M Ross**{ XE "Ross:M (1805–)" \f "Name" \b \i }. They had two sons: Joseph (1827–1897) and Daniel (1829–1899).

M was born in perh, Sandisfield,{ XE "USA, Massachusetts, Berkshire, Sandisfield, perh: :Ross, M (1805–)" \f "Place" } in 1805.

Sons of Daniel Sears and M Ross:

- m I. **Joseph⁶ Sears**{ XE "Sears:Joseph (1827–1897)" \f "Name" \b } was born in perh{ XE "USA, Massachusetts, Berkshire, Sandisfield, perh: :Sears, Joseph (1827–1897)" \f "Place" } in 1827. He died in 1897 at the age of 70.

²⁴ Ancestry.com, Massachusetts, Town and Vital Records, 1620-1988 (Provo, UT, USA, Ancestry.com Operations, Inc., 2011), Ancestry.com.
[Source citation includes one media item]

m II. **Daniel Sears**{ XE "Sears:Daniel (1829-1899)" \f "Name" \b } was born in perh{ XE "USA, Massachusetts, Berkshire, Sandisfield, perh: :Sears, Daniel (1829-1899)" \f "Place" } in 1829. He died in 1899 at the age of 70.

Family of Joshua Sears and Clarissa Bosworth{ TC "Joshua Sears and Clarissa Bosworth" \I 3 \f C}

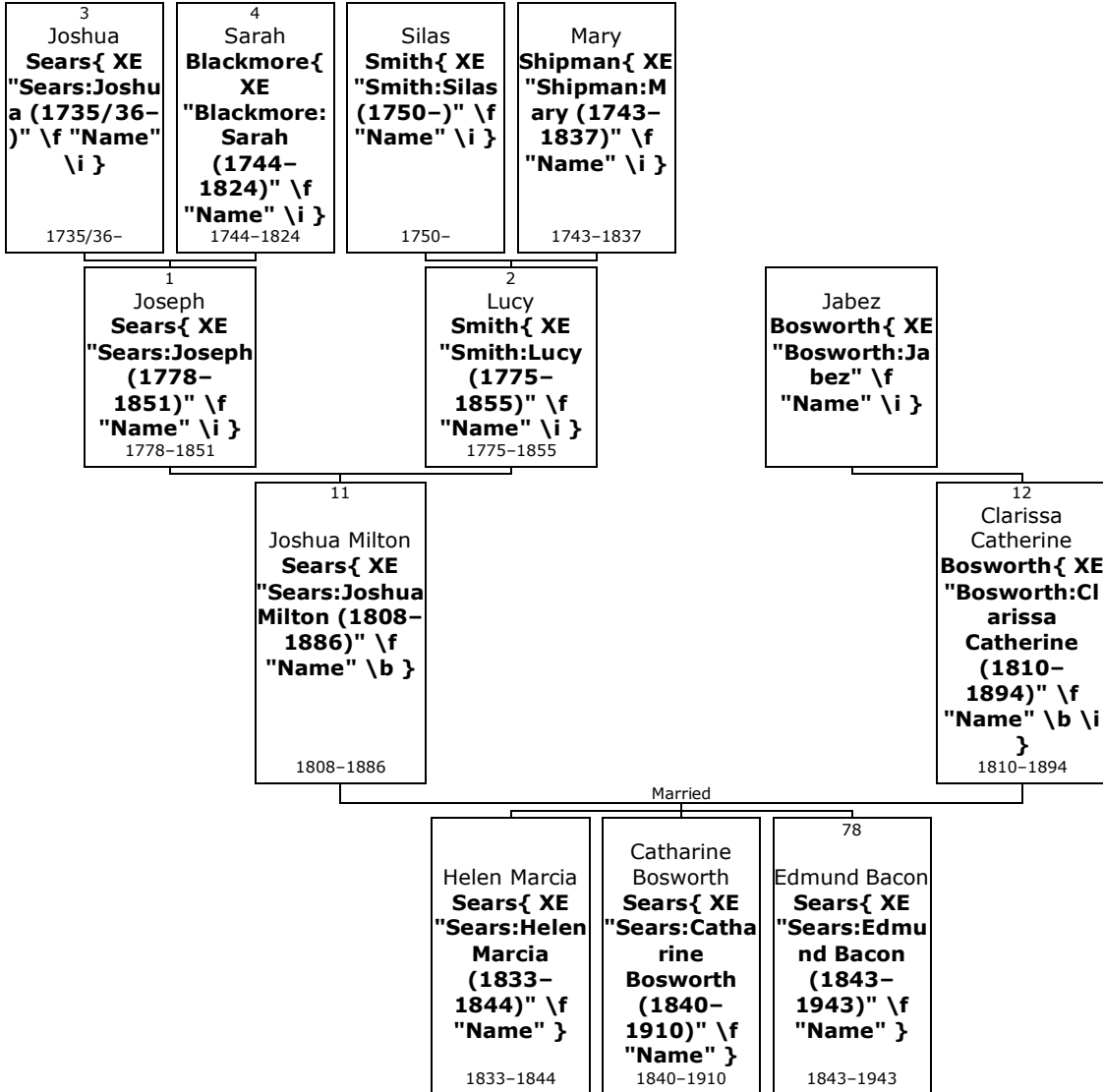

11. **Joshua Milton⁵ Sears**{ XE "Sears:Joshua Milton (1808-1886)" \f "Name" \b } (*Hon Joseph⁴, Sarah³ Blackmore*) was born on Monday, 19th September 1808, in Sandisfield, Berkshire, Massachusetts, USA{ XE "USA, Massachusetts, Berkshire, Sandisfield:(42.1126° N, 73.1432° W):Sears, Joshua Milton (1808-1886)" \f "Place" }.^[25, 26-27] He was the son of Joseph Sears{ XE "Sears:Joseph (1778-1851)" \f "Name" \i } (1) and Lucy Smith{ XE "Smith:Lucy (1775-1855)" \f "Name" \i } (2).

Joshua Milton died in Sandisfield{ XE "USA, Massachusetts, Berkshire, Sandisfield:(42.1126° N, 73.1432° W):Sears, Joshua Milton (1808-1886)" \f "Place" } on 24th August 1886, at the age of 77.^[25] He was buried

²⁵ Ancestry.com, U.S., Find A Grave Index, 1600s-Current (Provo, UT, USA, Ancestry.com Operations, Inc., 2012), Ancestry.com.

²⁶ Ancestry.com and The Church of Jesus Christ of Latter-day Saints, 1880 United States Federal Census (Provo, UT, USA, Ancestry.com Operations Inc, 2010), Ancestry.com, Year: 1880; Census Place: Sandisfield, Berkshire, Massachusetts; Roll: 520; Family History Film: 1254520; Page: 580C; Enumeration District: 038. [Source citation includes one media item]

²⁷ Ancestry.com, 1850 United States Federal Census (Provo, UT, USA, Ancestry.com Operations, Inc., 2009), Ancestry.com, Year: 1850; Census Place: Sandisfield, Berkshire, Massachusetts; Roll: M432_306; Page: 300A; Image: 597. [Source citation includes one media item]

in Sandisfield, Berkshire County{ XE "USA, Massachusetts, Berkshire County, Sandisfield:(42.1126° N, 73.1432° W):Sears, Joshua Milton (1808–1886)" \f "Place" }.^[25]

<https://www.wikitree.com/wiki/Sears-5170>

!S.P. May No 1244. p.368 Joshua Sears was prominent in town affairs, and was Rep. to State Leg. in 1862. He now lives in New Boston, Sandisfield, MA, with his son. J W Sears: possibly a third child Joshua M Sears 67,1,8 - returned to Yarmouth to remarry

!

!1880 United States Federal Census <http://www.ancestry.com/search/db.aspx?dbid=6742> Name: Joshua M. Sears Home in 1880: Sandisfield, Berkshire, Massachusetts Age: 72 Estimated birth year: abt 1808 Birthplace: Massachusetts Relation to Head of Household: Self (Head) Spouse's name: Katharine C. Father's birthplace: Massachusetts Mother's birthplace: Connecticut Occupation: Farmer Marital Status: Married Race: White Gender: Male

Household Members: Name Age

Joshua M. Sears 72

Katharine C. Sears 70

Edmond B. Sears 37

Jane L. Sears 35

Milton S. Sears 11

Jason Sears 7

Ellen M. Sears 3

!

!Find A Grave Memorial# 71030940

Joshua Milton Sears Birth Date: 19 Sep 1808 Age at Death: 77 Death Date: 24 Aug 1886 Burial Place: Sandisfield, Berkshire County, Massachusetts, USA URL: <http://www.findagrave.com/cgi-...> Birth: Sep. 19, 1808 SandisfieldBerkshire CountyMassachusetts, USA Death: Aug. 24, 1886 SandisfieldBerkshire County Massachusetts, USA Son of Joseph and Lucy Sears. Family links: Spouse:Catherine C. Bosworth Sears (1810 - 1894) *Children:Edmond Bacon Sears (1844 - 1916) *Burial:West New Boston Cemetery SandisfieldBerkshire County Massachusetts, USA Created by: Mark Wing Record added: Jun 08, 2011

!

!jjrbrown1 Feb 22 6:10 AM GMT Hi just a few little tid bits. Clrissa was wife wife of Joshua Milton Dears. She was born on 24 Aug 1810 in Sandisfield. Their first child, a girl, was Helen Marcia Sears, (13 Oct 1833-14 Dec 1844. Clarissa and Joshua lived in Sandisfueld, Mass. their whole life. Hope it helps. If you disagree with any of this please let me know at

jjrbrown@sbcglobal.net John J Brown

More facts and events for Joshua Milton Sears:

Residence: 1850 Sandisfield, Berkshire{ XE "USA, Massachusetts, Berkshire, Sandisfield:(42.1126° N, 73.1432° W):Sears, Joshua Milton (1808–1886)" \f "Place" }.^[27]

Residence: 1880 Sandisfield{ XE "USA, Massachusetts, Berkshire, Sandisfield:(42.1126° N, 73.1432° W):Sears, Joshua Milton (1808–1886)" \f "Place" }.^[26]
Marital Status: Married; Relation to Head: Self

- 12.** He married **Clarissa Catherine Bosworth**{ XE "Bosworth:Clarissa Catherine (1810–1894)" \f "Name" \b \i }.^[25, 26] They had three children: Helen (1833–1844), Catharine (1840–1910) and Edmund (1843–1943).

Clarissa Catherine was born in Massachusetts{ XE "USA, Massachusetts:(42.1562° N, 71.5662° W):Bosworth, Clarissa Catherine (1810–1894)" \f "Place" } in 1810.^[25, 26] She was the daughter of Jabez Bosworth{ XE "Bosworth:Jabez" \f "Name" \i }.

Clarissa Catherine reached 84 years of age and died on 20th July 1894.^[25] She was buried in Sandisfield{ XE "USA, Massachusetts, Berkshire, Sandisfield:(42.1126° N, 73.1432° W):Bosworth, Clarissa Catherine (1810–1894)" \f "Place" }.^[25]

Census Katharine

More facts and events for Clarissa Catherine Bosworth:

Residence: 1880 Sandisfield{ XE "USA, Massachusetts, Berkshire, Sandisfield:(42.1126° N,

73.1432° W):Bosworth, Clarissa Catherine (1810–1894)" \f "Place" }^[26]
Marital Status: Married; Relation to Head: Wife

Children of Joshua Milton Sears and Clarissa Catherine Bosworth:

- f I. **Helen Marcia⁶ Sears**{ XE "Sears:Helen Marcia (1833–1844)" \f "Name" \b } was born in Sandisfield{ XE "USA, Massachusetts, Berkshire, Sandisfield:(42.1126° N, 73.1432° W):Sears, Helen Marcia (1833–1844)" \f "Place" } on 13th October 1833. She died on 9th December 1844, at the age of 11.
- f II. **Catharine Bosworth Sears**{ XE "Sears:Catharine Bosworth (1840–1910)" \f "Name" \b } was born in Sandisfield{ XE "USA, Massachusetts, Berkshire, Sandisfield:(42.1126° N, 73.1432° W):Sears, Catharine Bosworth (1840–1910)" \f "Place" } on 1st August 1840.^[28] She died in 1910 at the age of 69.
- + 78 m III. **Edmund Bacon Sears**{ XE "Sears:Edmund Bacon (1843–1943)" \f "Name" } was born in Sandisfield{ XE "USA, Massachusetts, Berkshire, Sandisfield:(42.1126° N, 73.1432° W):Sears, Edmund Bacon (1843–1943)" \f "Place" } in April 1843.^[25, 26, 29] He died in Sandisfield{ XE "USA, Massachusetts, Berkshire, Sandisfield:(42.1126° N, 73.1432° W):Sears, Edmund Bacon (1843–1943)" \f "Place" } in 1943 at the age of 99.^[25]

²⁸ Ancestry.com, Massachusetts, Town and Vital Records, 1620-1988 (Provo, UT, USA, Ancestry.com Operations, Inc., 2011), Ancestry.com.

²⁹ Ancestry.com, 1910 United States Federal Census (Provo, UT, USA, Ancestry.com Operations Inc, 2006), Ancestry.com, Year: 1910; Census Place: Sandisfield, Berkshire, Massachusetts; Roll: T624_572; Page: 3B; Enumeration District: 0084; FHL microfilm: 1374585.

Family of Edmund Sears and Ellen Bacon{ TC "Edmund Sears and Ellen Bacon" \I 3 \f C}

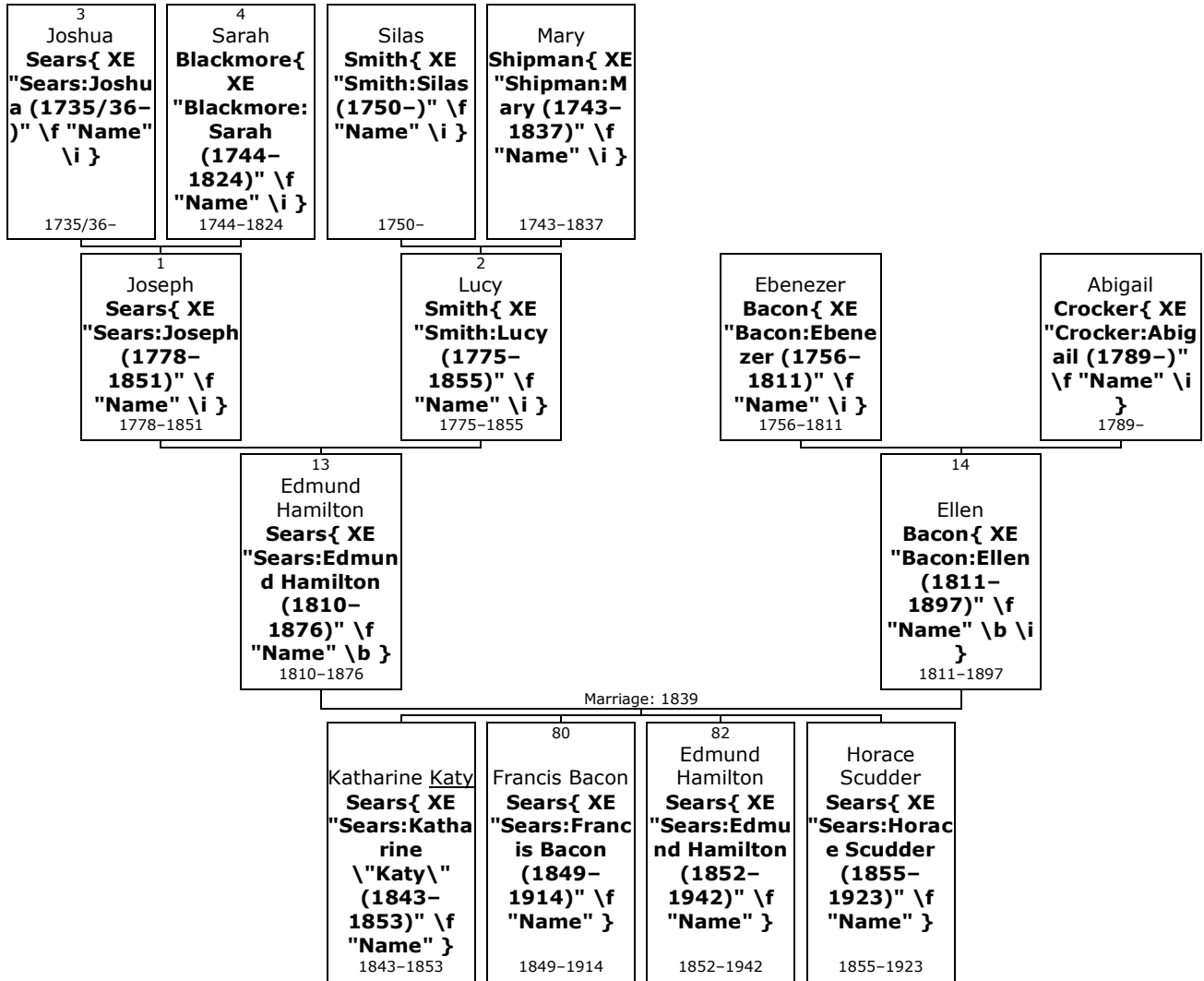

13. Rev Edmund Hamilton⁵ Sears{ XE "Sears:Edmund Hamilton (1810-1876)" \f "Name" \b } (*Hon Joseph⁴, Sarah³ Blackmore*) was born on Friday, 6th April 1810, in Sandisfield, Berkshire, Massachusetts, USA{ XE "USA, Massachusetts, Berkshire, Sandisfield:(42.1126° N, 73.1432° W):Sears, Edmund Hamilton (1810-1876)" \f "Place" }.^[30, 31-32] He was the son of Joseph Sears{ XE "Sears:Joseph (1778-1851)" \f "Name" \i } (1) and Lucy Smith{ XE "Smith:Lucy (1775-1855)" \f "Name" \i } (2).

Edmund Hamilton died in Weston, Middlesex,{ XE "USA, Massachusetts, Middlesex, Weston:(42.3668° N, 71.3031° W):Sears, Edmund Hamilton (1810-1876)" \f "Place" } on 16th January 1876, at the age of 65.^[30] He was buried in Weston{ XE "USA, Massachusetts, Middlesex, Weston:(42.3668° N, 71.3031° W):Sears, Edmund Hamilton (1810-1876)" \f "Place" }.^[30]

<https://www.wikitree.com/wiki/Sears-1725>

!Sturgis Library, Transcript of Barnstable Marriages by Mrs Grace V Held, p. 109, Rev Edmund (Wayland)

³⁰ Ancestry.com, U.S., Find A Grave Index, 1600s-Current (Provo, UT, USA, Ancestry.com Operations, Inc., 2012), Ancestry.com.

³¹ Ancestry.com, U.S. Passport Applications, 1795-1925 (Provo, UT, USA, Ancestry.com Operations, Inc., 2007), Ancestry.com, National Archives and Records Administration (NARA); Washington D.C.; NARA Series: Passport Applications, January 2, 1906 - March 31, 1925; Roll #: 1902; Volume #: Roll 1902 - Certificates: 144600-144975, 12 Apr 1922-13 Apr 1922. [Source citation includes one media item]

³² Ancestry.com, Massachusetts, Marriage Records, 1840-1915 (Provo, UT, USA, Ancestry.com Operations, Inc., 2013), Ancestry.com, New England Historic Genealogical Society; Boston, Massachusetts; Massachusetts Vital Records, 1911-1915. [Source citation includes one media item]

m. Ellen Bacon 13 Oct 1839

!

!Wayland VR BACON Ellen of Barnstable, and Rev. Edmund H. Sears, int. Oct. 9, 1839.

!

!S P May pp 369-370 No 1245, Rev Edmund H Sears was graduated at Union Coll. in 1834, and at Cambridge Theo. School in 1837; began to preach as a missionary at Toledo, OH, remaining nearly a year, - was ordained Pastor of 1st Church(Unitarian), Wayland, MA, 1839, installed as colleague of Dr Field, Pastor of the Unit. Church at Weston, MA, in May 1865, and succeeded him as Pastor in Nov 1869. He visited Europe in 1873, and was severely injured by the fall of a tree in his orchard in 1874. He was a man of singularly modest and retiring nature. His health had long been feeble, and he shrunk from personal display of any sort. But as a writer, as a preacher, and as a man, he has left a memory which will be long and lovingly cherished by all who knew him. A saintlier soul has rarely been enshrined in mortal frame. But for his early impaired health and enfeebled voice, he would have been deemed eloquent in utterance, no less than in style, for his delivery had every attractive and impressive quality, within the limited spaces in which he alone dared to seek a hearing. Those that knew him felt that his place was with the beloved apostle, in closest union and sympathy with his Divine Master. There was a sweet serenity of spirit in his whole demeanor, speech and character, which made him in every relation of life unspeakably dear. Simple, modest, unassuming, even diffident, he was the last person to make of set purpose any manifestation of piety; but a beauty of holiness so pure and radiant as his could not be kept under cover. All who came within its sphere felt profoundly the sanctity, purity and loveliness of its character. His style was the transcript of his thought and feeling. There was a view of high poetic inspiration, not only in those lyrics which are finding their place in the worship of Christian sanctuaries wherever the English tongue is spoken, but almost equally in his prose, which is never otherwise than rhythmical, glowing and fervent. Amongst other works of his were: lyrics to the Christmas song "It Came Upon a Midnight Clear", "Regeneration," "Athanasia," "The Fourth Gospel the Heart of Christ," "Sermons and Songs of the Christian Life," "Christian Lyrics etc, and he edited, with Rev R Ellis, "The Monthly Religious Magazine." In 1857 he published an historical romance entitled "Pictures of the Olden Time," in connection with which he edited the "Sears Genealogy," from papers furnished him by Hon David Sears [5768] of Boston, but which have since been found to contain much erroneous information based upon legends incapable of proof. See ante, "English Ancestry." !Sears In Memorium - 1898 Memorial of Little Katy ; At Sturgis Library, Barnstable, MA

!

!BIRTH-BIOGRAPHY: W J Burke and Will D Howe, Editors, American Authors and Books; 1640-1940; New York, Gramercy Publishing Co, 1943; pp 674-675; Book in Duncan Public Library, Duncan, OK; Unitarian clergyman, hymn writer. His best known hymns are "Calm on the listening ear of night," and "It came upon a Midnight clear."

!

!BIOGRAPHY:THE GOSPEL IN HYMNS; 1870; ; p 517; from Phebe Ann Glaze, N Hollywood, CA; Rev Edmund Hamilton Sears (1810-1876) American Unitarian. SEARS was a humble clergyman who lives only in two Christmas hymns. Born in the Massachusetts Berkshires, educated at Union College and the Harvard Divinity School (1837), he spent most of his life as pastor at Wayland, MA. In addition to his preaching he did editorial work for twelve years on the Monthly Religious Magazine and wrote several volumes on religious subjects. His first hymn, written while a divinity student, was "Calm on the listening ear of night" - still frequently used. His second is found in all of our hymnals. "It came upon a midnight clear" [1846]. No Christmas is perfect without the singing of this hymn. It is one of the finest ever written, not only because of its melodious rendering of the Biblical story of angels and shepherds (stanza 1) but because it is one of the first to emphasize the social significance of the angel's message (st 2-5). In stanza 2 unrolls the never-ending procession of Christmas days. The remembered angels and their song are reminders that the world was not intended to be weary, its plains need not be sad and lonely, nor its sounds a Babel instead of a symphony. These angels are the very hope of man springing eternally in the human breast. Stanza 3 hints at the actuality rather than the ideal: the devastations, the slaughter, the hatreds, the vengeance, the struggle for power, the savage greed of men have drowned out the celestial music for two milleniums. As the poet was writing these lines his fellow citizens were killing Mexicans in order that they might enslave more Negroes, and the Civil War was looming over the horizon. Stanza 4 becomes more personal. It urges all who find the burden of life too heavy-victims of poverty, disease, social injustice-to listen awhile to the angelic reminder that Good Will is heaven's law of life and can yet heal all their wounds. Stanza 5 relieves the picture of human wrongs by reminding us that the song is still valid. Eternal in the human heart springs the hope, the passioante faith, that what men so desperately have longed for - that "Age of Gold"- will surely come to pass. "Saints, apostles, prophets, martyrs" are all answering, "Yes!" It came upon the midnight clear, Tha glorious song of old, From angels bending near the earth To touch their harps of gold: Peace on the earth, goodwill to men, From heav'n's all gracious King! The world in solemn stillness lay To hear the angels sing. Still through the cloven skies they come, With peaceful wings

unfurled; And still their heav'nly music floats O'er all the weary world Above its sad and lowly plains They bend on hov'ring wing; And ever o'er its Babel sounds The blessed angels sing. Yet with the woes of sin and strife The world has suffered long; Beneath the angel-strain have rolled Two thousand years of wrong; And man, at war with man, hears not The love-song which they bring: O hush the noise, ye men of strife, And hear the angels sing! Fo lo! the days are hastening on, By prophet-bards foretold, When, with the ever-circling years, Comes round the age of gold; When peace shall over all the earth Its ancient splendours fling, And te whole world send back the song Which now the angels sing.

!

!Biography and Genealogy Master Index, 2d ed, Gale Research, ISBN 0-8103-1094-5, p140; Alli, Alli SUP, AmAu, AmAu&B, ApCAB, BiDAmm, ChPo,-S1,-S2, DcAmAu, DcAmB, DcNAA, Drake, NatCAB 8, OhA&B, PoChrch, REnAL, TwCBDA, WebE&AL, WhAm HS

!

!Mayflower Index: No. 29,932 Edmund H; spouse Ellen Bacon; father Joseph

!

!MA death records Sears Edmund Hamilton Weston 1876 vol 284 p198 Death

!

!http://tch.simplenet.com/bio/s/ehsears.htm 30 Sep 98 Edmund Hamilton Sears 1810-1876 -- Born: April 6, 1810, Sandisfield, Massachusetts. Sears attended Union College in Schenectady, New York, and Harvard Divinity School. He served at Unitarian churches in Wayland, Lancaster, and Weston, Massachusetts. He also helped edit the Monthly Religious Magazine. His works include: Regeneration (1854) Pictures of the Olden Time (1857) Sermons and Songs of the Christian Life (1875) Died: January 14, 1876, Weston, Massachusetts. Hymns: Calm on the Listening Ear of Night It Came upon the Midnight Clear ---- Wanted: Picture Place of burial If you can help with any of the "wanted" items, would you send us an e-mail? Thanks!

!

!Sears, Edmund Hamilton (6 Apr. 1810-16 Jan. 1876), clergyman, author, and hymn writer, was born in Sandisfield, Massachusetts, the son of Joseph Hamilton and Lucy Smith, farmers. A shy and fragile boy, Sears soon found that the harsh realities of agricultural life prevented him from regularly attending school. At sixteen he briefly enrolled for several months at Westfield (Massachusetts) Academy, and a few years later he met the entrance requirements for Union College in Schenectady, New York. A diligent student, he completed his bachelor's degree in three years, graduating in 1834. At an early age, Sears had shown an interest in poetry and writing sermons, and at Union his literary skills were recognized and encouraged. He helped edit the college newspaper and also won a prize for his verse. After graduating, Sears first began to read law in hopes of a legal career. An opportunity to teach at the Brattleboro (Vermont) Academy led him to study theology with Rev. Addison Brown, and Sears soon switched his vocational interests to the Christian ministry. He subsequently entered Harvard Divinity School and earned a theological degree in 1837. He then accepted an assignment with the American Unitarian Association and served two years as a missionary, preaching at various points near Toledo, Ohio. Upon returning to Massachusetts, he was invited to accept the pastorate of the Wayland Unitarian Church; there he was ordained on 20 February 1839. Later that year, Sears married Ellen Bacon of Barnstable, Massachusetts; they had three sons and a daughter. Sears's soft voice, shyness, and weak physical condition prevented him from serving larger and more active churches, and he preferred the peaceful and meditative pace that country parishes provided. He pastored the Unitarian society in Lancaster from 1841 to 1847, when poor health forced him to resign. After retiring to a small farm at Wayland, he regained sufficient strength to serve the Wayland parish again, ministering to it for the next seventeen years. Sears was proud of his New England heritage, which he traced to the Plymouth Colony in the 1630s. His genealogical research led to the publication of two works in 1857: Pictures of the Olden Time as Shown in the Fortunes of a Family of Pilgrims and Genealogies and Biographical Sketches of the Ancestry and Descendants of Richard Sears. He also wrote and published a local commemorative history, The Town of Wayland in the Civil War of 1861-1865. While pastoring the Wayland society, Sears became widely known throughout New England for his religious books, devotional verse, and editorial work (in association with Rufus Ellis) for the Unitarian periodical Monthly Religious Magazine (1851-1871). His sermons and other writings are marked with a richly devotional and mystical quality, as well as poetic grace and beauty. Among Unitarian leaders of his era, Sears was a "conservative" who held that Christianity was divinely inspired and that Christ (although not a member of the Trinity) was its divinely appointed author. Yet his piety was also influenced by the Platonic idealism of the Concord Transcendentalists and by the eighteenth-century Swedish scientist and religious visionary Emanuel Swedenborg. His Regeneration (1853), for example, which was written at the request of the American Unitarian Association, reflects Swedenborg's stages of spiritual growth; namely, confession, putting one's external life in order, and forming a new internal will. Athanasia; or, Foregleams of Immortality (1858), examines the nature of the soul and the afterlife and was praised by English poet Elizabeth Barrett Browning for its deep spiritual insights. Sears's last pastorate was in Weston, a neighboring town, where he served from 1866 until his death. While in Weston he published his most popular work, The Fourth

Gospel: The Heart of Christ (1872), which was reprinted several times. This work presented a rational life of Christ but also stressed the spiritual nature of the Resurrection, the importance of religious experience, and the mystical quality of John's gospel. Sears is best remembered, however, as a writer of poetry and hymns, reflected in his last two books, *Sermons and Songs of the Christian Life* (1875) and *Life in Christ* (1877). He may be the only American poet to write two Christmas carols that continue to be reprinted and frequently sung by Christians everywhere: "It Came upon a Midnight Clear" (1850) and "Calm, on the Listening Ears of Night" (c. 1834). An accidental fall from a tree in 1874 effectively ended his active pastoral work, although he continued to write. He died at his home in Weston.

!Bibliography Basic biographical information on Sears may be found in *History of the Church in Weston* (1909), and Samuel A. Elliot, *Heralds of a Liberal Faith*, vol. 3 (1910). A more thorough account is Chandler Robins, "Memoir of Rev. Edmund Hamilton Sears," *Proceedings of the Massachusetts Historical Society* 18 (1891). See also Albert Christ-Janer et al., comps., *American Hymns Old and New* (2 vols., 1980); George W. Cooke, *Unitarianism in America* (1902); Conrad E. Wright, *The Liberal Christians* (1970); and Wright, *American Unitarianism, 1805-1865* (1989). Obituaries and tributes are in the *Unitarian Review* (Feb. 1876); the *Christian Register*, 22 and 29 Jan. 1872; and the *Boston Daily Advertiser*, 18 Jan. 1876.

!Citation: David B. Eller. "Sears, Edmund Hamilton"; <http://www.anb.org/articles/08/08-01358.html>; American National Biography Online Feb. 2000. Access Date: Mon Dec 30 15:10:41 CST 2002 Copyright c. 2000 American Council of Learned Societies. Published by Oxford University Press. All rights reserved.

!http://print.google.com/print?hl=en&id=4SZAeKBQMBsC&dq=sears&prev=http://www.print.google.com/print%3Fq%3Dsears%26lr%3D%26start%3D50&lpg=PA5&pg=PA7&sig=66f15vZhjyo_rP6J0V5XDqYRwbA Regeneration 1854 No higher question can be offered to the human intellect, than that of the method of salvation by Jesus Christ. Its unmeasured importance is obvious to us, whenever in contemplative mood we open the pages of the New Testament, and find that a splendid apparatus of means has been provided; for we know that this would not have been done unless momentous interests were at issue. These two questions, What are we? and Whither do we tend? will at times press painfully upon thoughtful minds, and demand an answer. Ideals of a better state are haunting them, and producing within them unutterable longings after peace. There are three topics which cannot fail to command the interest and attention of those whose minds are revolving the great problem of life:-- The evil, depravity, and suffering involved in the human condition; the darkness that broods upon the earth and our own spirits. Conceptions of a better state; dreams of perfection...

!http://www.hds.harvard.edu/library/bms/bms00121.html Sears, Edmund Hamilton. Correspondence, 1837-1875. These letters came to the Divinity School Library half-a-dozen or more years ago, through the good offices of Rev. Dan Huntington Fenn, who was then minister in Wayland, Mass. They include a considerable number of letters from members of the family, and from correspondents (often female) who have read his books with pleasure. They also contain a considerable number that reveal Sear's interest in Swedenborgianism (see especially letters from B.F. Barrett), and others casting light on the Unitarian movement (see especially letters from Charles Lowe, Henry W. Bellows, A.P. Putnam, Rufus P. Stebbins, and DA. Wasson). Also a folder of replies to a questionnaire regarding use of Communion Service in Unitarian Churches of South Middlesex Conference, 1868. -Conrad Wright October, 1968

Container List: Correspondence bMS 121/1

(1) Allen A. Augusta bMS 121/1 (2) Anderson, Martha bMS 121/1 (3) Arnold E.R. bMS 121/1 (4) Ballard bMS 121/1 (5) Barrett, B.F. bMS 121/1 (6) Bellows, Henry W. bMS 121/1 (7) Bellows, Susan bMS 121/1 (8) Brigham, A.M. bMS 121/1 (9) Brooks, Charles bMS 121/1 (10) Browning, Henry B. bMS 121/1 (11) Buck bMS 121/1 (12) Bush, S. bMS 121/1 (13) Bushnell, Horace bMS 121/1 (14) Cattin, H.D. bMS 121/1 (15) Chandler, Mary G. bMS 121/1 (16) Child, Lydia Maria bMS 121/1 (17) Chope, R.R. bMS 121/1 (18) Church, P. bMS 121/1 (19) Clarke, W.T. bMS 121/1 (20) Collins, G. bMS 121/1 (21) Colman, Samuel bMS 121/1 (22) The Committee appointed to consider the expediency of publishing the report before the Philanthropic Society on the "Rise and Progress of Unitarianism" report bMS 121/1 (23) Cragin, Mary Jane bMS 121/1 (24) Dale, John bMS 121/1 (25) Dall, Charles Henry Appleton (includes two letters of his wife Caroline Heeley Dall) bMS 121/1 (26) Dehon, Arthur bMS 121/1 (27) Draper bMS 121/1 (28) Dudley, S.H. bMS 121/1 (29) Easton, P.L. bMS 121/1 (30) Eddy bMS 121/1 (31) Ellis, Rufus bMS 121/1 (32) Emerson, Ellen T. bMS 121/1 (33) Everett, Edward bMS 121/1 (34) Fernald, W.M. bMS 121/1 (35) Field, Anna bMS 121/1 (36) Fields, James T. bMS 121/1 (37) Fisher, Charlotte bMS 121/1 (38) Fisher, E.H. bMS 121/1 (39) Fisher, W. bMS 121/1 (40) Fiske bMS 121/1 (41) Flagg, Isaac bMS 121/1 (42) Foster, R.N. bMS 121/1 (43) Furness, William Henry bMS 121/1 (44) Gallup, Palmer bMS 121/1 (45) Glover, Susan bMS 121/1 (46) Goodhue, Anna bMS 121/1 (47) Guernsey, Egbert bMS 121/1 (48) Hall, T.B. bMS 121/1 (49) Hardy, Henry bMS 121/1 (50) Hayden, J.C. bMS 121/1 (51) Hayden, W.B. bMS 121/1 (52) Hayes, Florence bMS 121/1 (53) Heard, Ellen B. bMS 121/1 (54) Heuston, Harriet bMS 121/1 (55) Holland, E.G. bMS 121/1 (56) Homan, J.S. bMS 121/1 (57) Howell, M.S. bMS 121/1 (58) Hudson, C. James, Henry, Sr. (see bMS 121/2 (18)) bMS 121/1 (59) Jaquith, Abbie bMS 121/1 (60) Kellogg, B.

bMS 121/1 (61) Kellogg, Julia A. bMS 121/1 (62) Kierulff, Rose bMS 121/1 (63) Kimball, James William
bMS 121/1 (64) Krause, S.M. bMS 121/1 (65) Laster, R.N. bMS 121/1 (66) Lawrence, Margaret Woods
bMS 121/1 (67) Lincoln, S.B. bMS 121/1 (68) Lindsey, D.P. bMS 121/1 (69) Little, J.A.S. bMS 121/1 (70)
Lowe, Charles bMS 121/1 (71) Lowe, Martha P. bMS 121/1 (72) McIntire, C. bMS 121/1 (73) Mack, Mrs.
R.A. bMS 121/1 (74) Mason, Caroline A. bMS 121/1 (75) Merrell, Caroline G. bMS 121/2

!(1) Miles, Henry A. bMS 121/2 (2) Mills, Florence E. bMS 121/2 (3) Morison, E. bMS 121/2 (4) Morison,
J.H. bMS 121/2 (5) Nowell, William Gray bMS 121/2 (6) Packard, Charlotte bMS 121/2 (7) Page, A. bMS
121/2 (8) Palfrey, John G. bMS 121/2 (9) Parsons, Theophilus bMS 121/2 (10) Peabody, William Bourn
Oliver bMS 121/2 (11) Phillips, Ellen A. bMS 121/2 (12) Pitman, H. bMS 121/2 (13) Pollock, G.H. bMS
121/2 (14) Pollock, Louise bMS 121/2 (15) Potter, Thomas bMS 121/2 (16) Proudfoot bMS 121/2 (17)
Putnam, A.P. bMS 121/2 (18) James, Henry bMS 121/2 (19) Sears, J.M. bMS 121/2 (20) Shaw, Emily
bMS 121/2 (21) Shaw, R.G. bMS 121/2 (22) Shippen, Rush R. bMS 121/2 (23) Short, J.L. bMS 121/2
(24) Sibley, Charles bMS 121/2 (25) Silsbee, William bMS 121/2 (26) Smith, A.G. bMS 121/2 (27)
Spears, Robert bMS 121/2 (28) Stearns, C. bMS 121/2 (29) Stebbins, Rufus P. bMS 121/2 (30)
Strickland, E.P. bMS 121/2 (31) Tapley, H.M. bMS 121/2 (32) Thayer, M. bMS 121/2 (33) Thayer, N.
bMS 121/2 (34) Thurston bMS 121/2 (35) Upham, F.W. bMS 121/2 (36) Ware, Mary bMS 121/2 (37)
Warren, Edward bMS 121/2 (38) Wasson, David Atwood bMS 121/2 (39) Watson, M.F. bMS 121/2 (40)
Wellman, W.A. bMS 121/2 (41) Whiting, Maria bMS 121/2 (42) Whitmore, N.H. bMS 121/2 (43)
Whitmore, C.H. bMS 121/2 (44) Willard, E.N. bMS 121/2 (45) Willard, S.R. bMS 121/2 (46)
Worthington, A. bMS 121/2 (47) Wynn bMS 121/2 (48) Cousin Natilda bMS 121/2 (49) Unidentified
MISCELLANEOUS ITEMS bMS 121/2 (50) Answers to a questionnaire regarding use of Communion Service
in Unitarian Churches of South Middlesex Conference, 1868 bMS 121/2 (51) Undated manuscript from
W.E. Channing's Spirit bMS 121/2 (52) Undated and untitled manuscript bMS 121/2 (53) Newspaper
clippings SERMONS AND OTHER WRITINGS (in chronological order) bMS 121/3

!(1) 1837; report on Unitarian missionary work (with H.G.O. Blake) bMS 121/3 (2) 1837 (?); sermon on
Matt 11:16-17 entitled "Religious indifference" bMS 121/3 (3) July 1837; dissertation reading at Harvard
Divinity School commencement bMS 121/3 (4) Sept. 1837; sermon on 2 Kings 2:9-11 bMS 121/3 (5)
Dec. 1837; sermon on Lam 3:32-33 entitled "Enjoyment more abundant than misery" bMS 121/3 (6)
1838; sermon on Matt 19:16 bMS 121/3 (7) Jan. 1838; sermon on John 2:14 bMS 121/3 (8) Jan. 1838;
sermon on 1 Cor 15:35 entitled "The resurrection of the soul" bMS 121/3 (9) Feb. 1838; sermon on 1 Cor
15:53 bMS 121/3 (10) March 1838; sermon on John 3:2 bMS 121/3 (11) March 1838; sermon on Titus
1:15 entitled "The mind-creator of its own heaven" bMS 121/3 (12) March 1838; sermon on 2 Pet 1:16
bMS 121/3 (13) March 1838; sermon on 2 Pet 1:16 bMS 121/3 (14) March 11, 1838; sermon on 2 Pet 1:16
bMS 121/3 (15) April 1838; sermon on Job 38:28 bMS 121/3 (16) April 1838; sermon on Ezek 18:4
entitled "Spiritual death" bMS 121/3 (17) Aug. 1838; sermon on 1 Sam 24:17 entitled "Love of enemies"
bMS 121/3 (18) Dec. 1838; sermon on Matt 5:19 entitled "Small sins" bMS 121/3 (19) March 10, 1839;
sermon on Matt 5:18 entitled "Nature of the divine law" bMS 121/3 (20) April 1839; sermon on Ecc 7:3
bMS 121/3 (21) May 19, 1839; sermon on Luke 9:28-32 entitled "The transfiguration" bMS 121/3 (22)
June 2, 1839; sermon on Num 23:19 bMS 121/3 (23) Nov. 1839; sermon on John 19:5 entitled "The
humanity of Christ" bMS 121/3 (24) Feb. 2, 1840; sermon on John 21:7 entitled "That disciple whom Jesus
loved" bMS 121/3 (25) March 1840; sermon on Gen 1:1 bMS 121/3 (26) March 8, 1840; sermon on Matt
13:24-30 entitled "The wheat and the tares" bMS 121/3 (27) May 24, 1840; sermon on Luke 16:10 bMS
121/3 (28) July 5, 1840; sermon on John 1:14 bMS 121/3 (29) July 5, 1840; sermon on Eph 6:4 bMS
121/3 (30) July 19, 1840; sermon on Gen 2:3 and Ex 20:8-10 bMS 121/3 (31) July 19, 1840; sermon on
Mark 2:27 entitled "The Sabbath--how profaned" bMS 121/3 (32) Aug. 21, 1840; sermon on Mark 2:27
entitled "The Sabbath--how sanctified" bMS 121/3 (33) Jan. 5, 1841; sermon on Ps 90:12 entitled "The
voice of the past-- New Year, 1841" bMS 121/3 (34) Jan. 24, 1841; sermon on Rom 10:9-10 entitled
"Loving faith" bMS 121/3 (35) March 28, 1841; sermon on Matt 25:31-32 bMS 121/3 (36) April 1841;
sermon on Eph 6:4 entitled "Early religious education" bMS 121/3 (37) June 20, 1841; sermon on Gen 4:9
entitled "The exact of human responsibility" bMS 121/3 (38) June 20, 1841; sermon on James 5:16
entitled "The efficacy of prayer" bMS 121/4

!(1) July 1841; sermon on Luke 18:17 entitled "A child-like spirit in religion" bMS 121/4 (2) Aug. 1841;
sermon on 2 Cor 5:17 entitled "Experimental religion" bMS 121/4 (3) Sept. 1841; sermon on 1 Thess 4:13
entitled "The future life" bMS 121/4 (4) Sept. 4, 1841; sermon on Ecc 9:14 bMS 121/4 (5) Nov. 21, 1841;
sermon on Matt 5:5 entitled "Meekness" bMS 121/4 (6) 1842; sermon on Ps 4:6 entitled "Characteristics"
bMS 121/4 (7) Jan. 1842; sermon on Ecc 12:1 entitled "Early religion" bMS 121/4 (8) Jan. 1842; sermon
on James 2:10 entitled "The eternal law" bMS 121/4 (9) Jan. 1, 1842; sermon on Ps 90:10 entitled
"Procrastination" bMS 121/4 (10) Jan. 30, 1842; sermon on Gen 1:26 and Mark 12:29 bMS 121/4 (11)
March 1842; sermon on Matt 22:37 entitled "Love to God" bMS 121/4 (12) March 1842; sermon on 1 John

4:8 entitled "The love of God" bMS 121/4 (13) March 13, 1842; sermon on Ps 139:7 entitled "Omnipresence of the deity" bMS 121/4 (14) March 13, 1842; sermon on Matt 5:37 entitled "Evil communication" bMS 121/4 (15) June 1842; sermon on Eph 6:14-15 entitled "The influence and value of principles" bMS 121/4 (16) June 1842; sermon on Heb 2:10 entitled "The sufferings of Christ" bMS 121/4 (17) July 1842; sermon on James 1:4 entitled "Perfect and entire" bMS 121/4 (18) Aug. 1842; sermon on Rom 8:19 entitled "The redemption of the world" bMS 121/4 (19) Sept. 1842; sermon on Matt 26:24 entitled "The humanity of Christ" bMS 121/4 (20) Oct. 1842; sermon on Ps 37:37 entitled "Death of Channing" bMS 121/4 (21) Oct. 2, 1842; sermon on 2 Cor 10:5 entitled "Obedience" bMS 121/4 (22) Oct. 23, 1842; sermon on 1 Thess 5:19 entitled "Quench not the spirit" bMS 121/4 (23) Oct. 23, 1842; sermon on unidentified subject bMS 121/4 (24) Nov. 1842; sermon on Is 60:18 entitled "The prospects of society" bMS 121/4 (25) Nov. 11, 1842; sermon on Gen 1:27 entitled "Human nature" bMS 121/4 (26) Dec. 1842; sermon on Rom 8:18 entitled "Suffering" bMS 121/4 (27) Jan. 1843; sermon on Rom 7:9 entitled "Religious experience" bMS 121/4 (28) Feb. 1843; sermon on Ex 33:18-23 bMS 121/4 (29) Feb. 1843; sermon on Luke 16:31 bMS 121/4 (30) March 1843; sermon on Ps 34:8 entitled "Religious experience" bMS 121/4 (31) April 1843; sermon on Matt 11:28 bMS 121/4 (32) June 1843; sermon on Philip 4:8 entitled "Things just..." bMS 121/4 (33) July 1843; sermon on John 5:28-29 bMS 121/4 (34) July 1843; sermon on 1 Cor 13:1 bMS 121/4 (35) Aug. 1843; sermon on Acts 17:21 bMS 121/4 (36) Aug. 23, 1843; sermon on Col 1:28 bMS 121/4 (37) Sept. 1843; sermon on Heb 12:11 entitled "Rises and changes of adversity" bMS 121/4 (38) Sept. 3, 1843; sermon on Rom 8:15 entitled "The filial relation between men" bMS 121/4 (39) Oct. 1, 1843; sermon on Rev 21:1 entitled "The church" bMS 121/5

!(1) Nov. 1843; sermon on Luke 23:43 bMS 121/5 (2) Nov. 1843; sermon on Rom 14:17 bMS 121/5 (3) Nov. 1, 1843; sermon on Ecc 12:6 entitled "Early religion" bMS 121/5 (4) Dec. 1843; sermon on Rev 20:12 bMS 121/5 (5) Dec. 17, 1843; sermon on Rom 12:11 entitled "Religious fervor" bMS 121/5 (6) Dec. 25, 1843; sermon on Is 60:2 bMS 121/5 (7) Dec. 31, 1843; sermon on Ex 16:18 bMS 121/5 (8) 1844; sermon on 2 Sam 23:3-4 entitled "Public virtue" bMS 121/5 (9) Jan. 7, 1844; sermon on Matt 21:30 entitled "Good resolutions" bMS 121/5 (10) Feb. 4, 1844; sermon on Matt 16:25-26 bMS 121/5 (11) Feb. 18, 1844; sermon on Luke 24:47 entitled "Repentance--its efficacy" bMS 121/5 (12) March 3, 1844; sermon on 1 Sam 24:17 bMS 121/5 (13) April 1844; sermon on Matt 6:9 bMS 121/5 (14) April 1844; sermon on Matt 18:3 entitled "Conversion by repentance" bMS 121/5 (15) Easter 1844; sermon on Rom 10:9 entitled "The resurrection" bMS 121/5 (16) May 1844; sermon on Luke 17:15-18 bMS 121/5 (17) May 1, 1844; sermon on John 21:15 bMS 121/5 (18) June 1844; sermon on Luke 22:32 entitled "Duties of Christians to each other" bMS 121/5 (19) July 1844; sermon on Matt 5:4 bMS 121/5 (20) Aug. 18, 1844; sermon on Ps 139:5 entitled "Omnipresence of God" bMS 121/5 (21) Oct. 1844; sermon on Rom 1:20 and Luke 14:18 entitled "Excuses for sin" bMS 121/5 (22) Nov. 1844; sermon on Luke 16:9 entitled "Covetousness/Ceasar" bMS 121/5 (23) Thanksgiving 1845; sermon on Ecc 3:14 and James 2:8-26 entitled "Compensation" bMS 121/5 (24) Dec. 1845; sermon on Luke 22:31-32 entitled "Conversion" bMS 121/5 (25) Dec. 1845; sermon on Rom 2:29 and Prov 29:25 bMS 121/5 (26) Dec. 7, 1845; sermon on Heb 12:2 entitled "Looking unto Jesus" bMS 121/5 (27) Dec. 31, 1845; sermon on Acts 20:31 bMS 121/5 (28) 1846; sermon on Is 1:22-23 entitled "Corruption of the times" bMS 121/5 (29) 1846; sermon on James 4:13-14 bMS 121/5 (30) Jan. 1846; sermon on Ps 48:8 entitled "Tomorrow--1846" bMS 121/5 (31) Jan. 1846; sermon on John 14:2 entitled "The many mansions" bMS 121/5 (32) Feb. 1, 1846; sermon on Matt 27:54 entitled "Natural and moral miracle" bMS 121/5 (33) April 1846; sermon on Prov 22:11 entitled "Education" bMS 121/5 (34) April 1846; sermon on Matt 18:14 entitled "Sunday school--Easter" bMS 121/5 (35) May 4, 1846; sermon on Matt 10:35-36 entitled "Home" bMS 121/5 (36) April 30, 1849; sermon on Heb 12:22 entitled "The law and the gospel" bMS 121/5 (37) Dec. 1849; sermon on John 3:7 entitled "Regeneration" bMS 121/5 (38) Dec. 1849; sermon on Acts 10:30-31 entitled "Domestic worship" bMS 121/5 (39) Jan. 1850; sermon on Matt 3:2 entitled "Repeat..." bMS 121/5 (40) July 1850; sermon on Esra 3:12 bMS 121/5 (41) July 1850; sermon on Matt 10:28 entitled "Hell--soul and body" bMS 121/5 (42) July 1850; sermon on Titus 1:15 entitled "Man--a creator" bMS 121/5 (43) Sept. 1850; sermon on Matt 12:30 bMS 121/5 (44) Sept. 1850; sermon on Eph 4:8 bMS 121/5 (45) Nov. 1850; sermon on Prov 29:18 entitled "Culture of the imagination" bMS 121/5 (46) Nov. 1850; sermon on John 4:25 entitled "Worship" bMS 121/5 (47) Nov. 1850; sermon on John 16:7 bMS 121/5 (48) Dec. 1850; sermon on Is 60:18 entitled "Religious prosperity" bMS 121/5 (49) Dec. 1850; sermon on Micah 6:8

!Sears, Edmund Hamilton 1810-1876

Allibone's Critical Dictionary of English Literature. British and American authors living and deceased from the earliest accounts to the latter half of the Nineteenth Century. Three volumes. By S. Austin Allibone. Philadelphia: J.B. Lippincott & Co., 1858-1871. Reprint. Detroit: Gale Research, 1965. (Alli)

Allibone's Critical Dictionary of English Literature: A Supplement. British and American authors. Two volumes. By John Foster Kirk. Philadelphia: J.B. Lippincott & Co., 1891. Reprint. Detroit: Gale Research, 1965. (Alli SUP)

- American Authors, 1600-1900. A biographical dictionary of American literature. Edited by Stanley J. Kunitz and Howard Haycraft. Wilson Authors Series. New York: H.W. Wilson Co., 1938. (AmAu) American Authors and Books. 1640 to the present day. Third revised edition. By W.J. Burke and Will D. Howe. Revised by Irving Weiss and Anne Weiss. New York: Crown Publishers, 1972. (AmAu&B)
- American National Biography. 24 volumes. Edited by John A. Garraty and Mark C. Carnes. New York: Oxford University Press, 1999. (AmNatBi)
- Appleton's Cyclopaedia of American Biography. Six volumes. Edited by James Grant Wilson and John Fiske. New York: D. Appleton & Co., 1888-1889. Reprint. Detroit: Gale Research, 1968. (ApCAB)
- Biographical Dictionary of American Music. By Charles Eugene Claghorn. West Nyack, NY: Parker Publishing Co., 1973. (BiDAmM)
- Biography Index. A cumulative index to biographical material in books and magazines. Volume 7: September, 1964-August, 1967. New York: H.W. Wilson Co., 1968. (BioIn 7)
- Childhood in Poetry. A catalogue, with biographical and critical annotations, of the books of English and American poets comprising the Shaw Childhood in Poetry Collection in the Library of the Florida State University. First edition. By John Mackay Shaw. Detroit: Gale Research, 1967. (ChhPo)
- Childhood in Poetry. A catalogue, with biographical and critical annotations, of the books of English and American poets comprising the Shaw Childhood in Poetry Collection in the Library of the Florida State University. First Supplement. By John Mackay Shaw. Detroit: Gale Research, 1972. (ChhPo S1)
- Childhood in Poetry. A catalogue, with biographical and critical annotations, of the books of English and American poets comprising the Shaw Childhood in Poetry Collection in the Library of the Florida State University. Second Supplement. By John Mackay Shaw. Detroit: Gale Research, 1976. (ChhPo S2)
- A Dictionary of American Authors. Fifth edition, revised and enlarged. By Oscar Fay Adams. New York: Houghton Mifflin Co., 1904. Reprint. Detroit: Gale Research, 1969. Biographies are found in the "Dictionary of American Authors" section which begins on page 1 and in the "Supplement" which begins on page 441. (DcAmAu)
- Dictionary of American Biography. Volumes 1-20. New York: Charles Scribner's Sons, 1928-1936. (DcAmB)
- A Dictionary of North American Authors Deceased before 1950. Compiled by W. Stewart Wallace. Toronto: Ryerson Press, 1951. Reprint. Detroit: Gale Research, 1968. (DcNAA)
- Drake's Dictionary of American Biography. Including men of the time, containing nearly 10,000 notices of persons of both sexes, of native and foreign birth, who have been remarkable, or prominently connected with the arts, sciences, literature, politics, or history, of the American continent. By Francis S. Drake. Boston: James R. Osgood & Co., 1872. Reprint. Detroit: Gale Research, 1974. (Drake)
- The National Cyclopaedia of American Biography. Volume 8. New York: James T. White & Co., 1898. Reprint. Volumes 1-50. Ann Arbor, Mich.: University Microfilms, 1967-1971. Use the Index to locate biographies. (NatCAB 8)
- Ohio Authors and Their Books. Biographical data and selective bibliographies for Ohio authors, native and resident, 1796-1950. Edited by William Coyle. Cleveland: World Publishing Co., 1962. (OhA&B)
- The Poets of the Church. A series of biographical sketches of hymn-writers with notes on their hymns. By Edwin F. Hatfield. New York: Anson D.F. Randolph & Co., 1884. Reprint. Detroit: Gale Research, 1978. (PoChrch)
- The Reader's Encyclopedia of American Literature. By Max J. Herzberg. New York: Thomas Y. Crowell Co., 1962. (REnAL)
- The Twentieth Century Biographical Dictionary of Notable Americans. Brief biographies of authors, administrators, clergymen, commanders, editors, engineers, jurists, merchants, officials, philanthropists, scientists, statesmen, and others who are making American history. 10 volumes. Edited by Rossiter Johnson. Boston: The Biographical Society, 1904. Reprint. Detroit: Gale Research, 1968. (TwCBDA)
- Webster's New World Companion to English and American Literature. Edited by Arthur Pollard. New York: World Publishing Co., 1973. (WebE&AL)
- Who Was Who in America. A component volume of "Who's Who in American History." Historical Volume, 1607-1896. Revised Edition. Chicago: Marquis Who's Who, 1967. (WhAm HS) !
- !http://www.uua.org/uuhs/duub/articles/edmundhamiltonsears.html Edmund Hamilton Sears (April 6, 1810-January 16, 1876), a Unitarian parish minister and author, was understood in his day to be conservative and not in sympathy with either "broad church" or "radical" Unitarians. He wrote a number of theological works influential among liberal Protestants, inside and outside the Unitarian fold. Sears's fame is due to his composition of the quintessentially Unitarian Christmas carol, "It Came upon the Midnight Clear." The youngest of three sons of Joseph and Lucy (Smith) Sears, Edmund grew up on a farm within sight of the Berkshire Hills, in Sandisfield, Massachusetts. He told his friend and colleague, Chandler Robbins, that as a child he had fancied the hilltops to rise up near heaven, where "bright-robed messengers alighted and rested, as they came and went on their errands of love." From his father Edmund learned to

appreciate poetry. He wrote that as a child, "[w]hen at work, some poem was always singing through my brain." From both parents he learned the importance of moral duty. Though they encouraged his love of study, the burden of farm labor prevented regular school attendance. Yet in 1831 his education was advanced enough for his admission as a sophomore at Union College in Schenectady, New York. He won a college prize for his poetry. Upon graduation Sears studied law for nine months under a lawyer in Sandisfield. He then taught at Brattleboro (Vermont) Academy, and soon began to study for the ministry under Addison Brown, minister of the Unitarian Church in Brattleboro. Attracted by the writings of Boston divines William Ellery Channing & articles/williamellerychanning.html and Henry Ware, Sears went on to study at the Theological School in Cambridge, Massachusetts, 1834-37. He did student preaching in Barnstable, Massachusetts, where he met Ellen Bacon. They married in 1839. In the meantime the American Unitarian Association supported Sears's work as a missionary in the frontier area around Toledo, Ohio. In late 1838 he supplied the pulpit for the First Congregational Church and Society in Wayland, Massachusetts. Impressed by his character and his preaching, the church extended a call to settle with them. He accepted, and the church ordained and installed him as minister in February, 1839. Many years later, Sears explained that he had never been ambitious for a large city pulpit or for the prominence of such a position. Rather, he was drawn by "the quiet beauty of Wayland with its sylvan life and little parish." Though he found Wayland pleasing, Sears learned that to provide for his family he needed to serve a larger, more prosperous church. His successful ministry at the Congregational Church in Lancaster, 1840-47, was, however, cut short by illness and depression. Unable afterwards to preach in a voice loud enough to be heard by a large congregation or to sustain the work of a large parish, Sears returned to Wayland for a year of rest and recovery. When his health had improved, he was recalled to the Wayland ministry and served there 1848-65. With a lighter workload he spent much of his time writing. As a student Sears had written a Christmas carol, "Calm on the Listening Ear of Night," 1834, his lyrics describing the mystical moment when the angels' anthem burst upon the silent hills and plains of Palestine. It was printed in many American hymnals. But it was his carol, "It Came upon the Midnight Clear," first performed in Wayland in 1849, that achieved lasting popularity. Writing during a period of personal melancholy, and with news of revolution in Europe and the United States' war with Mexico fresh in his mind, Sears portrayed the world as dark, full of "sin and strife," and not hearing the Christmas message: And man, at war with man, hears not The love-song which they bring: O hush the noise, ye men of strife, And hear the angels sing. Some have criticized "It Came upon the Midnight Clear" for its unscriptural references to "prophet-bards" and an "age of gold," and for never mentioning the Christ-child. A century after the carol was written, British carol scholar Erik Routley wrote that "in its original form, the hymn is little more than an ethical song, extolling the worth and splendour of peace among men." Ironically, the piety and theology of Edmund Sears, author of this "humanist" carol, were intensely Christ-centered. "The word God may be uttered without emotion," he told his congregation, "while the word Jesus opens the heart, and touches the place of tears." Sears believed in a Christ fully human and fully divine, the incarnation of the Divine Word, and the mediator who alone could bridge "the awful gulf between God and man." Sears's was a high Christology, with an Arminian leavening: God reaches down from a great distance to humanity, through his Son and angels, but his "peace" is contingent upon a human response. In fact Sears cared little about any technical terms of the relationship between God and Christ. He wrote, "I do not believe that any analysis in the power of man can ever reduce to scientific proposition the mystic union between Christ and Father. Neither Trinity, nor Unity, neither Arian, nor Sabellian, nor Socinian, can ever give you such a psychology of the Divine nature as to bring it all within the grasp of the finite understanding." To Sears Jesus was neither a primarily historical figure, "disappeared into the distant past," nor a subject for "theological pugilism," but an experience in daily life. He found the "living Christ" best presented in the Gospel of John. A product of his lifelong biblical study, *The Fourth Gospel the Heart of Christ*, 1872, was his most widely-read work. In *Regeneration*, 1853, commissioned by the Executive Committee of the American Unitarian Association, Sears dealt with the degenerative and regenerative tendencies at work in human nature and the path to salvation. Though he rejected the orthodox doctrine of original sin, he was not as sanguine about the human condition as some Unitarians. He saw all human groups and individuals as more or less tainted with hereditary and progressive corruption. At the same time he wrote of people as fashioned in the image of God and blessed with varying degrees of development in their spiritual nature. Like his other works, *Athanasia, or Foregleams of Immortality*, 1858, gives expression to strains of Platonic Idealism which also, in a different setting, inform Emerson's Transcendentalism. In *Athanasia* Sears spoke of death and resurrection as the emergence of a person's inner nature "which comes out of the natural body as a rose out of the bursting calyx." Sears added to his revised edition of this work, *Foregleams and Foreshadows of Immortality*, 1873, a discussion of other religions. Finding these "provisional," he yet allowed that "all the great faiths of the world have enough in them of the good and true to save the people who live under them if they live obedient thereto." Although some Unitarian contemporaries thought Sears's positions conservative, they would have been considered highly unorthodox in other churches. His theological investigations and his use of language were entirely too independent for any but a liberal church. According to Samuel A. Eliot & articles/samuelatkinseliotii.html, his works "bear on every page the mark of original research, candid

judgment, sincere desire for truth, and charm of literary style." Sears's friend, Lydia Maria Child <articles/lydiamariachild.html>, who lived in Wayland and shared his interest in Swedenborgian mysticism, sometimes attended his services. "I love and reverence Mr. Sears," she wrote, "though I cannot quite agree with all his conclusions." He had not the temperament of a reformer, but as she observed, "He had no reluctance to incur obloquy in vindication of the right." Sears preached the equality of women and men. In a satirical poem from his *Fire-side Colloquies*, 1847, he argued that it was just as wrong to kill in a war as in private life and that, as soldiers killed at the order of the President, the chief executive ought to be punished: And does he make men shoot and kill? Then let some pious folk, A gallows build at Washington, And hang up Mr. Polk! After the Fugitive Slave Law was passed, Sears declared from his pulpit that "when the human and the Divine law were in conflict it was the duty of all to obey the latter." In a widely-circulated sermon, *Revolution or Reform*, 1856, he predicted that the crime of slavery, "persevered in and unrepented of," would lead to a national retribution. "Every time we have dallied with the slave power we have sown the wind, and every year it becomes more certain that we shall reap the whirlwind!" After the Civil War, Sears resigned his Wayland pastorate in order to spend all his time writing. He returned to ministry in 1866, however, succeeding the elderly Joseph Field in nearby Weston, Massachusetts. From 1859-71 he was also associate editor of the *Monthly Religious Magazine*. In 1865 Henry Whitney Bellows <articles/henrywhitneybellows.html>, then preparing to organize a new Unitarian body, the National Conference, classified Sears as an "Evangelical," one of a few ministers who "want to secede & are disposed to deny any fellowship with the looser & more liberal party." But Sears did not secede. He did make known a practical, rather than a theological concern, asking in the *Monthly Religious Magazine* in 1870, "How long can anyone suppose that contributions will flow largely and spontaneously into the treasury of the Association or the Conference, from churches that stand squarely on their covenants, while such a state of things [i.e., a wide range of markedly differing theological stances] is suffered to exist." Chandler Robbins noted that Edmund Sears was not a highly partisan sectarian. "He walked and worked with a sect only so far as he believed that its faith and practice conformed to the spirit and precepts of the Great Head of the Church: and he worked with it in the hope that he might influence and help its representatives to be true and loyal to their Heavenly Master?but no further." In the summer of 1873 Sears enjoyed a tour of Europe. In 1874, while working in his garden, he fell from a tree. From that time he was rarely free of illness and pain. Shortly before he died he wrote, in "My Psalm," And pain, which in the long, long hours Keeps on night and day, Through these fast-crumbling walls to thee Finds a new opening way. Papers relating to the life and ministry of Edmund H. Sears are at the Wayland Historical Society and at the Andover-Harvard Theological Library in Cambridge, Massachusetts. In addition to the works mentioned above, Sears wrote *Genealogy and Biographical Sketches of the Ancestry and Descendants of Richard Sears, the Pilgrim* (1857); *Pictures of the Olden Time* (1857); *Hindrances to a Successful Ministry* (1858); *Christian Lyrics* (1860); *The Town of Wayland in the Civil War of 1861-65*; *Sermons and Songs of the Christian Life* (1875); *Christ in the Life* (1877); *Last Sermon Written, but Not Preached, with Chandler Robbins's Sermon in Commemoration of Rev. E. H. Sears* (1876); and various articles, printed sermons, and tracts. Sears wrote between 40 and 50 hymns. There is no full-length biography of Sears. Shorter biographical pieces include Chandler Robbins, "Memoir of Rev. Edmund Hamilton Sears," *Proceedings of the Massachusetts Historical Society* (1891); *In Memoriam: Edmund Hamilton Sears, Ellen Bacon Sears, Katherine Sears* (1898); a chapter in Samuel A. Eliot, *Heralds of a Liberal Faith*, vol. 3 (1910); Thomas D. Wintle, "Gentle Prophet of the Liberal Soul," in *A New England Village Church: The First Church in Lancaster* (1985); an entry by David B. Eller in *American National Biography* (1999); and a 1998 paper for Andover Newton Theological School by Madeleine M. Sifantus, "Edmund Hamilton Sears Biographical Sketch and Transcriptions of His Notebooks From 1834 and 1835." For information on Sears's role in denominational politics see Charles Lowe, *A Statement in Regard to the Position and Policy of the American Unitarian Association: Chiefly in Reply to Letters by Rev. E.H. Sears and Rev. Francis E. Abbot* (1868) and Conrad Wright, "Henry W. Bellows and the Organization of the National Conference," *The Liberal Christians* (1970). On how he was viewed by Lydia Maria Child, see Carolyn L. Karcher, *The First Woman In the Republic: A Cultural Biography of Lydia Maria Child* (1994) and Milton Meltzer and Patricia G. Holland, editors, *Lydia Maria Child: Selected Letters, 1817-1880* (1982). For an angle on Sears's theology see Daniel Walker Howe, "The Cambridge Platonists of Old England and the Cambridge Platonists of New England," in Conrad Edick Wright, *American Unitarianism, 1805-1865* (1989). There is information on the most famous carol in Kenneth Sawyer, *The Christmas Homily: It Came Upon the Midnight Clear* (1997); Erik Routley, *The English Carol* (1958) and Ian Bradley, *The Penguin Book of Carols* (1999) provide modern non-Unitarian Universalist analysis and evaluation. Article by Peter Hughes <authors/peterhughes.html>

!
!

!http://www.hds.harvard.edu/library/bms/bms00121.html It being nearly the Fourth of July i just stumbled upon a poem by one of our favorites, E. H. Sears (you remember Rev Sears who wrote the words to It Came Upon A Midnight Clear?) from the Boston Investigator, Wed Dec 17, 1862, p 264 Poetry and Anecdotes. Song of the Stars and Stripes We see the gallant streamer yet Float from the bastioned wall.

One hearty song for fatherland : That banner shall not fall. Last on our gaze, when outward bound We plough the ocean's foam; First on our longing eyes again To waft our welcome home. Beneath thy shade we've toiled in peace; The golden corn we reap; We've taken home our bonny brides; We've rocked our babes to sleep; We marched to front the battle-storms That brought the invaders nigh, When the grim lion cowered and sank Beneath the eagle's eyes. Beneath the stars and stripes we'll keep, Come years of weal or woe : Close up, close up the broken line, And strike the traitors low! Ho, brothers of the "border States"! We reach across the line, And pledge our faith and honor now As once in Auld Lang Syne. We'll keep the memories bright and green Of all our old renown; We'll strike the traitor hand that's raised To pluck the eagle down: Still shall it guard your Southern homes From all the foes that come. We'll move with you to harp and flute, Or march to fife and drum Or, if ye turn from us in scorn, Still shall our nation's sign Roll out again its streaming stars On all the border line; And, with the same old rallying-cry, Beneath its folds we'll meet, And they shall be our conquering sign, Or be our winding sheet. I guess a pre-civil war reference? Boston Daily Advertiser, (Boston, MA) Friday, December 25, 1868; pg. 2; Issue 152; col B

!

!A Christmas Sermon Historical Pictures and Their Lesson Rev. Edmund H. Sears. Category: News http://infotrac.galegroup.com/itw/infomark/484/331/10660604w16/purl=rc1_NCNP_0_GT3015783097&dyn=10!xrn_51_0_GT3015783097&hst_1?sw_aep=mlyn_b_nenghist_paywall

14. At the age of 29, Edmund Hamilton married **Ellen Bacon**{ XE "Bacon:Ellen (1811-1897)" \f "Name" \b \i } on Sunday, 13th October 1839, in Barnstable{ XE "USA, Massachusetts, Barnstable:(41.7199° N, 70.2508° W):Sears, Edmund Hamilton (1810-1876)" \f "Place" } when she was 28 years old.^[30, 32] They had four children: Katy (1843-1853), Francis (1849-1914), Edmund (1852-1942) and Horace (1855-1923).

Ellen was born in Barnstable{ XE "USA, Massachusetts, Barnstable:(41.7199° N, 70.2508° W):Bacon, Ellen (1811-1897)" \f "Place" } on Thursday, 11th April 1811.^[30] She was the daughter of Ebenezer Bacon{ XE "Bacon:Ebenezer (1756-1811)" \f "Name" \i } and Abigail Crocker{ XE "Crocker:Abigail (1789-)" \f "Name" \i }.

Ellen reached 86 years of age and died in Weston, Middlesex,{ XE "USA, Massachusetts, Middlesex, Weston:(42.3668° N, 71.3031° W):Bacon, Ellen (1811-1897)" \f "Place" } on 24th April 1897.^[30] She was buried in Weston{ XE "USA, Massachusetts, Middlesex, Weston:(42.3668° N, 71.3031° W):Bacon, Ellen (1811-1897)" \f "Place" }.^[30]

!S.P. May hand notes indicate she died after book was published <http://www.uuwhs.org/cgi-bin/findher.cgi> Unitarian Universalist Women's Heritage Society Sears, Ellen Bacon 1811-1897 Unit MA Ladies' Benevolent Society h. Rev. Edward Hamilton Sears

Children of Edmund Hamilton Sears and Ellen Bacon:

- | | | |
|------|---|--|
| | f | I. Katharine Katy⁶ Sears { XE "Sears:Katharine \"Katy\" (1843-1853)" \f "Name" \b } was born in Lancaster, Worcester,{ XE "USA, Massachusetts, Worcester, Lancaster:(42.4557° N, 71.6731° W):Sears, Katharine \"Katy\" (1843-1853)" \f "Place" } on 25 th February 1843. ^[30] She died in Wayland, Middlesex,{ XE "USA, Massachusetts, Middlesex, Wayland:(42.3626° N, 71.3614° W):Sears, Katharine \"Katy\" (1843-1853)" \f "Place" } on 12 th January 1853, at the age of 9. ^[30] Katy was buried in Weston{ XE "USA, Massachusetts, Middlesex, Weston:(42.3668° N, 71.3031° W):Sears, Katharine \"Katy\" (1843-1853)" \f "Place" }. ^[30] |
| + 80 | m | II. Francis Bacon Sears { XE "Sears:Francis Bacon (1849-1914)" \f "Name" } was born in Wayland, Middlesex,{ XE "USA, Massachusetts, Middlesex, Wayland:(42.3626° N, 71.3614° W):Sears, Francis Bacon (1849-1914)" \f "Place" } on 21 st January 1849. ^[30, 32, 33] He died in Wayland{ XE "USA, Massachusetts, Middlesex, Wayland:(42.3626° N, 71.3614° W):Sears, Francis Bacon (1849-1914)" \f "Place" } in July 1914 at the age of 65. ^[30] |
| + 82 | m | III. Edmund Hamilton Sears { XE "Sears:Edmund Hamilton (1852-1942)" \f "Name" } was born in perh, Wayland,{ XE "USA, Massachusetts, Middlesex, Wayland, perh: :Sears, Edmund Hamilton (1852-1942)" \f "Place" } on 20 th April 1852. ^[31, 34] He died in Los Angeles, California,{ XE "USA, California, Los Angeles:(34.1847° N, 118.262° |

³³ Ancestry.com, 1910 United States Federal Census (Provo, UT, USA, Ancestry.com Operations Inc, 2006), Ancestry.com, Year: 1910; Census Place: Boston Ward 11, Suffolk, Massachusetts; Roll: T624_618; Page: 7A; Enumeration District: 1424; FHL microfilm: 1374631.

³⁴ Ancestry.com, California, Death Index, 1940-1997 (Provo, UT, USA, Ancestry.com Operations Inc, 2000), Ancestry.com, Date: 1942-07-29.

W):Sears, Edmund Hamilton (1852–1942)" \f "Place" } on 29th July 1942, at the age of 90.^[34]

m

IV. **Horace Scudder Sears**{ XE "Sears:Horace Scudder (1855–1923)" \f "Name" \b } was born in Wayland{ XE "USA, Massachusetts, Middlesex, Wayland:(42.3626° N, 71.3614° W):Sears, Horace Scudder (1855–1923)" \f "Place" } on 26th February 1855.^[35, 36] He died in Weston{ XE "USA, Massachusetts, Middlesex, Weston:(42.3668° N, 71.3031° W):Sears, Horace Scudder (1855–1923)" \f "Place" } on 21st April 1923, at the age of 68.^[36]

Horace

More facts and events for Horace Scudder Sears:

Residence:

Weston{ XE "USA, Massachusetts, Middlesex, Weston:(42.3668° N, 71.3031° W):Sears, Horace Scudder (1855–1923)" \f "Place" }^[35]

³⁵ Ancestry.com, U.S. Passport Applications, 1795-1925 (Provo, UT, USA, Ancestry.com Operations, Inc., 2007), Ancestry.com, National Archives and Records Administration (NARA); Washington D.C.; NARA Series: Passport Applications, 1795-1905; Roll #: 592; Volume #: Roll 592 - 01 Feb 1902-28 Feb 1902.

³⁶ Barnstable Patriot, obit.

Related 2 Steps Removed{ TC "Related 2 Steps Removed" \f C}

Grandparents{ TC "Grandparents" \I 2 \f C}

Family of Joshua Sears and Rebecca Mayo{ TC "Joshua Sears and Rebecca Mayo" \I 3 \f C}

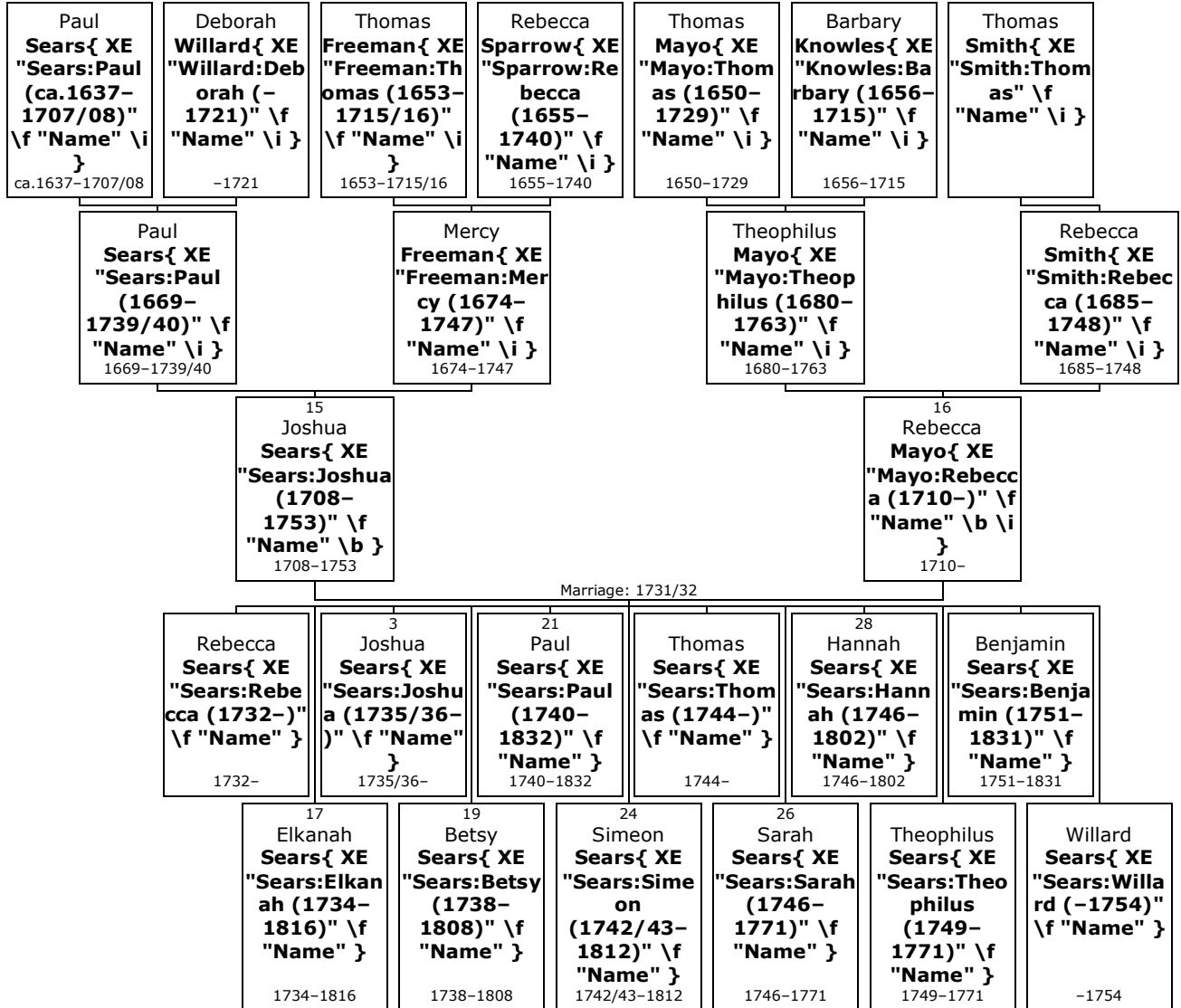

15. **Joshua² Sears**{ XE "Sears:Joshua (1708-1753)" \f "Name" \b } was born on 20th November 1708, in Yarmouth, Barnstable, Massachusetts, USA{ XE "USA, Massachusetts, Barnstable, Yarmouth:(41.7057° N, 70.2286° W):Sears, Joshua (1708-1753)" \f "Place" }.^[37, 38, 39, 40, 41, 42-43] He was the son of Paul Sears{

³⁷ Heritage Consulting, Millennium File (Provo, UT, USA, Ancestry.com Operations Inc, 2003), Ancestry.com.

³⁸ Ancestry.com, U.S., Sons of the American Revolution Membership Applications, 1889-1970 (Provo, UT, USA, Ancestry.com Operations, Inc., 2011), Ancestry.com, Volume: 310; SAR Membership Number: 61912. [Source citation includes one media item]

³⁹ Ancestry.com, Mayflower Births and Deaths, Vol. 1 and 2 (Provo, UT, USA, Ancestry.com Operations, Inc., 2013), Ancestry.com. [Source citation includes one media item]

⁴⁰ Ancestry Family Trees (Online publication - Provo, UT, USA: Ancestry.com. Original data: Family Tree files submitted by Ancestry members.), Ancestry.com, Database online. Record for Paul Sears. <http://search.ancestry.com/cgi-bin/sse.dll?db=pubmembertrees&h=-1694269941&indiv=try>.

XE "Sears:Paul (1669–1739/40)" \f "Name" \i } and Mercy Freeman{ XE "Freeman:Mercy (1674–1747)" \f "Name" \i }.

He died at Age: 24 in Middletown, Middlesex, Connecticut,{ XE "USA, Connecticut, Middlesex, Middletown:(41.5623° N, 72.6506° W):Sears, Joshua (1708–1753)" \f "Place" } on 27th September 1753, at the age of 44.^[37, 38, 40–42] Joshua was sealed to his parents on 14th April 1943.^[40] ;SLAKE.

<https://www.wikitree.com/wiki/Sears-1728>

!Yar VR p.69 pub. Jan 2 1731/2

!

! S.P. May p.84 Joshua Sears was Constable of Harwich in 1745. He was a man of large stature, and of great strength and hardihood. In 1746, he removed to Middletown, CT, and purchased land on the east side of the Connecticut river, in that part of town afterward set off as Chatham.

In Col. Rec. Ct., vol. X, we find the memorial of Rebecca Sears, admx, to the Assembly, setting forth that debts exceeded personal estate by £ 135 16 10, and asking liberty to sell real estate. [Public Records of CT,May 1755,p. 385 'Upon the memorial of Rebekah Sears, administratrix on the estate of Joshua Sears late of Middleton, deceased, shewing to this Assembly that the debts and charges due from said estate surmount the moveable part of said estate the sum of £135 16s. 10d. old tenor, and thereupon praying for liberty to sell lands, &c.: Resolved by this Assembly, that the memorialist have liberty, and she is hereby fully authorized and impowered, to make sale of so much of the lands of said deceased as will procure the aforesaid sum together with the incident charges arising on such sale; taking the direction of the court of probate in the district of Middleton therein.'] Mar. 9, 1732, Ebenr Nickerson deeded to Joshua Sears, for the consideration of £ 532, "about 36 acres of land with the buildings, &c., eastward of Point of Rocks, Harwich, 3 Lots: First, the eastern-most originally laid out to Capt. Jona. Bangs; ---. Second, to successors Mark Snow; --. Third, the westward to Thos. Clark, bounded on Dea. Chillingsworth Foster, Nathaniel Hopkins, John Freeman, and Clark & Cole lot." I have found no record of marriage of Theophilus, or Benjamin Sears; but think Dr. Willard Leonard Sears, (p. 578 #1) b. Glastenbury, CT, Sep 16, 1816, derived from one of them, perhaps Benjamin, as he named his eldest son Benjamin Willard Sears.

!

! Mayflower Index: No. 29,971 Joshua; spouse Rebecca Mayo; mother No 13,942

!

! Massachusetts, Marriages, 1633-1850 Name: Rebeckah Mayo Gender: Female Spouse: Joshua Sears Marriage Date: 2 Jan 1731 City: Yarmouth County: Barnstable Source: Family History Library, Salt Lake City, UT, Film # 0945512.

Genealogical and family history of the State of Connecticut : a record of the achievements of her people in the making of a commonwealth and the founding of a nation - Authors: Cutter, William Richard, 1847-1918 <https://archive.org/stream/genealogicalfami001cutt#page/245/mode/2up>Publication: New York, New York : Lewis Historical Pub. Co., c1911

- 16.** Joshua married **Rebecca Mayo**{ XE "Mayo:Rebecca (1710–)" \f "Name" \b \i } on 10th February 1731/32, in Eastham, Barnstable, Massachusetts{ XE "USA, Massachusetts, Barnstable, Eastham:(41.8301° N, 69.9739° W):Sears, Joshua (1708–1753)" \f "Place" }.^[39, 43, 44] They had twelve children: Rebecca (1732–), Elkanah (1734–1816), Joshua (1735/36–), Betsy (1738–1808), Paul (1740–1832), Simeon (1742/43–1812), Thomas (1744–), Sarah (1746–1771), Hannah (1746–1802), Theophilus (1749–1771), Benjamin (1751–1831) and Willard (–1754).

Rebecca was born in Harwich{ XE "USA, Massachusetts, Barnstable, Harwich:(41.6862° N, 70.0758° W):Mayo, Rebecca (1710–)" \f "Place" } on 2nd December 1710.^[39, 44] She was the daughter of Theophilus Mayo{ XE "Mayo:Theophilus (1680–1763)" \f "Name" \i } and Rebecca Smith{ XE "Smith:Rebecca (1685–1748)" \f "Name" \i }.

⁴¹ Ancestry.com, Connecticut, Deaths and Burials Index, 1650-1934 (Provo, UT, USA, Ancestry.com Operations, Inc., 2011), Ancestry.com.

⁴² Ancestry.com, Connecticut Town Death Records, pre-1870 (Barbour Collection) (Provo, UT, USA, Ancestry.com Operations Inc, 2006), Ancestry.com.
[Source citation includes one media item]

⁴³ Dodd, Jordan, Liahona Research, comp, Massachusetts, Marriages, 1633-1850 (Provo, UT, USA, Ancestry.com Operations Inc, 2005), Ancestry.com.

⁴⁴ Ancestry.com, Massachusetts, Town and Vital Records, 1620-1988 (Provo, UT, USA, Ancestry.com Operations, Inc., 2011), Ancestry.com.
[Source citation includes one media item]

Rebecca died in Middletown, Middlesex, Connecticut{ XE "USA, Connecticut, Middlesex, Middletown:(41.5623° N, 72.6506° W):Mayo, Rebecca (1710-)" \f "Place" }.

!some confusion about which Rebecca Mayo this is - prob dau. of Theophilus and Rebecca (Smith) Mayo rather than the original John Mayo and Susanna Freeman

!

!The information on the Sears website exists ;however, Rebecca Mayo: BIRTH: b 2 DEC 1710

!

!The Mayflower Descendant vol 5, page 203. CHRISTENING: The Mayflower Descendant vol 5,page 20; NOTE: Baptized with her four younger siblings at Brewster Church, Harwick. MARRIAGE: The Mayflower Descendant vol 13, page 69. MARRIAGE-SPOUSE: Harwich and Chatham, Mass. Genealogical, by Vernon R. Nickerson Ed. P 76. Sutro Library, San Francisco, CA F74 H42 N5.

Rebecca Mayo 5 (Theophilus Mayo⁴, Thomas³, Nathaniel², Rev. John¹): was born Dec. 2, 1710, d/o Theophilus Mayo⁴ and Rebecca Smith. I don't have a date or place of death for her, but she married Joshua Sears in Eastham on Feb. 10, 1731/32 and Joseph Doane married them. Joshua Sears died Sept. 27, 1753 at age 44 yrs. in Middletown, CT. Their children were: Rebecca, Elkanah, Joshua, Elizabeth, Paul, Simeon, Willard, Hannah, Theophilus, and Benjamin Sears. This family also found their way to CT. They went from Harwich, MA. to Middletown, Ct. Rebecca Sears was the daughter of Theophilus⁵ Mayo as he referred to her as "Rebecca Sears" in his 1758 will Barnstable Co. PR 13:10-12 from Susan Roser e-mail and Jean Rodwick e-mail Thank-you for your reply, however, since I posted this message I have learned that my Rebecca Mayo, the daughter of Theophilus Mayo and Rebecca Smith was born 2 Dec 1710 in Harwich, Barnstable, MA and died in Middletown, Middlesex Co., Connecticut. swellington@verizon.net

Daniel Rogers dantrogers@hotmail.com 13 Mar 2011 I just looked this up and this Rebecca does have four younger siblings at one point! It is short ride from Orleans to Harwich.

!

! The Mayflower Descendant Vol VII 1905, p. 28 [p. 51 Eastham and Orleans Vital Records] Theophilus Mayo and Rebecca Smith were married by Capta Sparrow august ye 16th 1705 Asa Mayo the son of ... was Born at Eastham July ye 29th 1706 Isaac Mayo 16 Jun 1708 Rebecca Mayo 2 Dec 1710 Ebenezer Mayo 1 Mar 1712/13 Experience Mayo 3 Apr 1716 Theophilus Mayo 17 Sep 1718 ____ dau 30 Jul 1721 ____ 22 Sep 1724 d. 13 Oct 1724

Vernon Nickerson also thinks she was daughter of Theophilus (I wonder where he found her m. by Joseph Doane- maybe that listed her parents? names- there was a Joseph Doane, J.P.):

From: Daniel Rogers [mailto:dantrogers@hotmail.com] Sent: Saturday, March 12, 2011 11:43 PM To: lrsears@cox.net Subject: Joshua Sears's wife Dear Leslie: I've been searching for the answer to which Rebecca Mayo married Joshua Sears. There is much confusion on the internet. There are 2 Rebecca Mayos in Eastham who are closely related and are of about the same age: b. 10 Oct 1713, dau. of John Mayo (b. 8 Jan 1862) and Susan Freeman and b. 2 Dec 1710, dau. of Theophilus Mayo (b. 31 Oct 1680) and Rebecca Smith. You state at your website: <http://searsr.com/richard1/pafg07.htm#54> that Theophilus's will (Barnstable Co. PR 13:10-12 from Susan Roser) calls her Rebecca Sears. Does he call her a daughter in his will? I'd like to see the text of Theophilus's will, as I was unable to find it at the American Ancestors website. It's would also be nice to know who the other Rebecca Mayo married -- if she lived to adulthood. By the way, we are 11th cousins 1 time removed in 2 different ways. One is from William Brewster (b. 1535), the other is from Hugh Sargent (b. 1530) and Margaret Gifford. Sincerely, Dan Rogers Daniel Thomas Rogers 1240 Takena St. SW Albany, OR 97321 USA 541-967-1911

Children of Joshua Sears and Rebecca Mayo:

- f I. **Rebecca³ Sears**{ XE "Sears:Rebecca (1732-)" \f "Name" \b } was born in Yarmouth{ XE "USA, Massachusetts, Barnstable, Yarmouth:(41.7057° N, 70.2286° W):Sears, Rebecca (1732-)" \f "Place" } on 14th November 1732. She was christened in Harwich{ XE "USA, Massachusetts, Barnstable, Harwich:(41.6862° N, 70.0758° W):Sears, Rebecca (1732-)" \f "Place" } on 24th June 1739.
- + 17 m II. **Elkanah Sears**{ XE "Sears:Elkanah (1734-1816)" \f "Name" } was born in Harwich{ XE "USA, Massachusetts, Barnstable, Harwich:(41.6862° N, 70.0758° W):Sears, Elkanah (1734-1816)" \f "Place" } on 12th April 1734.^[41, 45, 46, 47, 48-49] He died in East Hampton,

⁴⁵ Ancestry.com, Web: Connecticut, Find A Grave Index, 1636-2013 (Provo, UT, USA, Ancestry.com Operations, Inc., 2012), Ancestry.com.

⁴⁶ Ancestry.com, North America, Family Histories, 1500-2000 (Provo, UT, USA, Ancestry.com Operations, Inc., 2016), Ancestry.com, Book Title: Lineage Book : NSDAR : Volume 106 : 1913.

- Middlesex, Connecticut, { XE "USA, Connecticut, Middlesex, East Hampton:(41.5759° N, 72.5026° W):Sears, Elkanah (1734–1816)" \f "Place" } on 24th November 1816, at the age of 82.^[41, 45-50]
- + 3 m III. **Joshua Sears**{ XE "Sears:Joshua (1735/36–)" \f "Name" } was born in Harwich{ XE "USA, Massachusetts, Barnstable, Harwich:(41.6862° N, 70.0758° W):Sears, Joshua (1735/36–)" \f "Place" } on 14th February 1735/36. He died in Sandisfield, Berkshire{ XE "USA, Massachusetts, Berkshire, Sandisfield:(42.1126° N, 73.1432° W):Sears, Joshua (1735/36–)" \f "Place" }.
- + 19 f IV. **Betsy Sears**{ XE "Sears:Betsy (1738–1808)" \f "Name" } was born in Harwich{ XE "USA, Massachusetts, Barnstable, Harwich:(41.6862° N, 70.0758° W):Sears, Betsy (1738–1808)" \f "Place" } on 19th June 1738. She died in 1808 at the age of 69.
- + 21 m V. **Paul Sears**{ XE "Sears:Paul (1740–1832)" \f "Name" } was born in Harwich{ XE "USA, Massachusetts, Barnstable, Harwich:(41.6862° N, 70.0758° W):Sears, Paul (1740–1832)" \f "Place" } on 18th October 1740.^[49] He died in Sandisfield, Berkshire, { XE "USA, Massachusetts, Berkshire, Sandisfield:(42.1126° N, 73.1432° W):Sears, Paul (1740–1832)" \f "Place" } on 19th August 1832, at the age of 91.^[49, 51]
- + 24 m VI. **Simeon Sears**{ XE "Sears:Simeon (1742/43–1812)" \f "Name" } was born in Harwich{ XE "USA, Massachusetts, Barnstable, Harwich:(41.6862° N, 70.0758° W):Sears, Simeon (1742/43–1812)" \f "Place" } on 14th January 1742/43. He died in 1812 at the age of 68.
- m VII. **Thomas Sears**{ XE "Sears:Thomas (1744–)" \f "Name" \b } was born in Harwich{ XE "USA, Massachusetts, Barnstable, Harwich:(41.6862° N, 70.0758° W):Sears, Thomas (1744–)" \f "Place" } in 1744.
- + 26 f VIII. **Sarah Sears**{ XE "Sears:Sarah (1746–1771)" \f "Name" } was born in perh, Harwich,{ XE "USA, Massachusetts, Barnstable, Harwich, perh: :Sears, Sarah (1746–1771)" \f "Place" } in 1746. She died in New Marlborough, Berkshire,{ XE "USA, Massachusetts, Berkshire, New Marlborough:(42.1229° N, 73.2287° W):Sears, Sarah (1746–1771)" \f "Place" } on 27th March 1771, at the age of 25.
- + 28 f IX. **Hannah Sears**{ XE "Sears:Hannah (1746–1802)" \f "Name" } was born in 1746.^[49] She died in New Marlborough, Berkshire,{ XE "USA, Massachusetts, Berkshire, New Marlborough:(42.1229° N, 73.2287° W):Sears, Hannah (1746–1802)" \f "Place" } on 3rd June 1802, at the age of 56.^[44, 49]
- m X. **Theophilus Sears**{ XE "Sears:Theophilus (1749–1771)" \f "Name" \b } was born in Middletown, Middlesex, Connecticut,{ XE "USA, Connecticut, Middlesex, Middletown:(41.5623° N, 72.6506° W):Sears, Theophilus (1749–1771)" \f "Place" } on 2nd April 1749.^[52, 53] He died in 1771 at the age of 21.
- m XI. **Benjamin Sears**{ XE "Sears:Benjamin (1751–1831)" \f "Name" \b } was born in Middletown{ XE "USA, Connecticut, Middlesex, Middletown:(41.5623° N, 72.6506° W):Sears, Benjamin (1751–1831)" \f "Place" } on 3rd November 1751. He died in 1831 at the age of 79.
- m XII. **Willard Sears**{ XE "Sears:Willard (–1754)" \f "Name" \b }. Willard was christened in Harwich, Barnstable, Massachusetts,{ XE "USA, Massachusetts, Barnstable, Harwich:(41.6862° N, 70.0758° W):Sears, Willard (–1754)" \f "Place" } on 24th March 1744. He died on 24th August 1754.

⁴⁷ Ancestry.com, Connecticut, Hale Cemetery Inscriptions and Newspaper Notices, 1629-1934 (Provo, UT, USA, Ancestry.com Operations, Inc., 2012), Ancestry.com.

⁴⁸ Ancestry.com, U.S., Sons of the American Revolution Membership Applications, 1889-1970 (Provo, UT, USA, Ancestry.com Operations, Inc., 2011), Ancestry.com, SAR Membership Number: 93072.

⁴⁹ Ancestry.com, U.S., Find A Grave Index, 1600s-Current (Provo, UT, USA, Ancestry.com Operations, Inc., 2012), Ancestry.com.

⁵⁰ Ancestry.com, Connecticut, Church Record Abstracts, 1630-1920 (Provo, UT, USA, , 2013), Ancestry.com.

⁵¹ Centennial Edition, Part 3, Page 2601, DAR Patriot Index.

⁵² Edmund West, comp., Family Data Collection - Individual Records (Provo, UT, USA, Ancestry.com Operations Inc, 2000), Ancestry.com, Birth year: 1749; Birth city: Middletown; Birth state: CT.

⁵³ Ancestry.com, Connecticut Town Birth Records, pre-1870 (Barbour Collection) (Provo, UT, USA, Ancestry.com Operations Inc, 2006), Ancestry.com.

Uncles/aunts{ TC "Uncles/aunts" \I 2 \f C}

Family of Elkanah Sears and Ruth White{ TC "Elkanah Sears and Ruth White" \I 3 \f C}

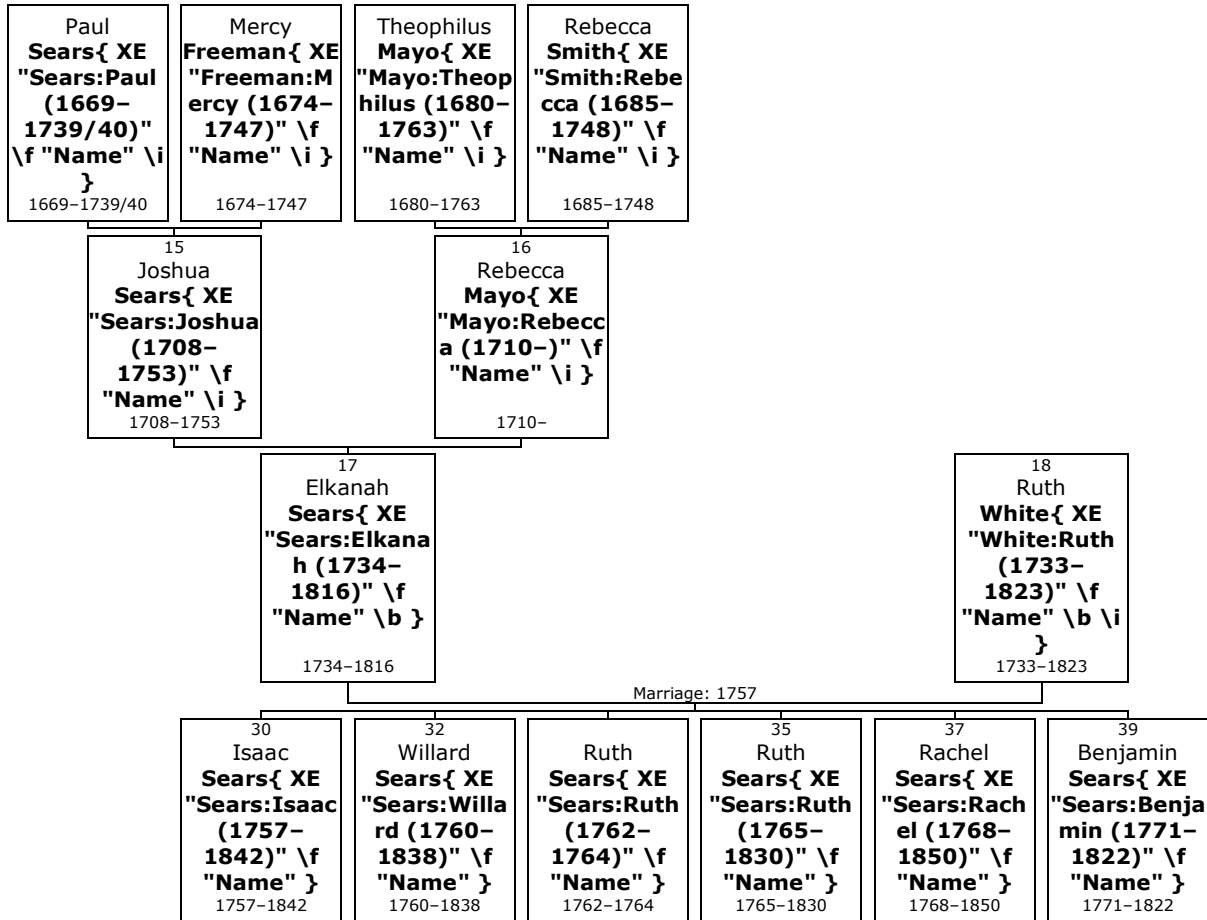

17. Capt Elkanah³ Sears{ XE "Sears:Elkanah (1734-1816)" \f "Name" \b } (*Joshua*²) was born on 12th April 1734, in Harwich, Barnstable, Massachusetts, USA{ XE "USA, Massachusetts, Barnstable, Harwich:(41.6862° N, 70.0758° W):Sears, Elkanah (1734-1816)" \f "Place" }.^{[54, 55, 56, 57, 58, 59, 60, 61, 62, 63-}

⁵⁴ Ancestry.com, Web: Connecticut, Find A Grave Index, 1636-2013 (Provo, UT, USA, Ancestry.com Operations, Inc., 2012), Ancestry.com.

⁵⁵ Ancestry.com, North America, Family Histories, 1500-2000 (Provo, UT, USA, Ancestry.com Operations, Inc., 2016), Ancestry.com, Book Title: Lineage Book : NSDAR : Volume 106 : 1913. [Source citation includes one media item]

⁵⁶ Ancestry.com, Connecticut, Hale Cemetery Inscriptions and Newspaper Notices, 1629-1934 (Provo, UT, USA, Ancestry.com Operations, Inc., 2012), Ancestry.com. [Source citation includes one media item]

⁵⁷ Ancestry.com, U.S., Sons of the American Revolution Membership Applications, 1889-1970 (Provo, UT, USA, Ancestry.com Operations, Inc., 2011), Ancestry.com, SAR Membership Number: 93072. [Source citation includes one media item]

⁵⁸ Ancestry.com, Connecticut, Deaths and Burials Index, 1650-1934 (Provo, UT, USA, Ancestry.com Operations, Inc., 2011), Ancestry.com.

⁵⁹ Ancestry.com, U.S., Find A Grave Index, 1600s-Current (Provo, UT, USA, Ancestry.com Operations, Inc., 2012), Ancestry.com.

⁶⁰ Ancestry.com, Connecticut, Church Record Abstracts, 1630-1920 (Provo, UT, USA, , 2013), Ancestry.com. [Source citation includes one media item]

⁶¹ Ancestry.com, 1810 United States Federal Census (Provo, UT, USA, Ancestry.com Operations, Inc., 2010), Ancestry.com, Year: 1810; Census Place: Chatham, Middlesex, Connecticut; Roll: 2; Page: 286; Image: 00296; Family History Library Film: 0281230. [Source citation includes one media item]

^{64]} He was the son of Joshua Sears{ XE "Sears:Joshua (1708–1753)" \f "Name" \i } (15) and Rebecca Mayo{ XE "Mayo:Rebecca (1710–)" \f "Name" \i } (16).

Elkanah was christened on 24th June 1739. He died in East Hampton{ XE "USA, Connecticut, Middlesex, East Hampton:(41.5759° N, 72.5026° W):Sears, Elkanah (1734–1816)" \f "Place" } on 24th November 1816, at the age of 82.^[54–60] Elkanah was buried in Lakeside Cemetery, East Hampton{ XE "USA, Connecticut, Middlesex, East Hampton, Lakeside Cemetery: :Sears, Elkanah (1734–1816)" \f "Place" }.^[54, 56, 59]

<https://www.wikitree.com/wiki/Sears-1760>

!Harwich VR p. 67 [Vol I p. 228] b. Elknah

!

!S.P. May, No 198, p. 135 Capt Elkanah Sears removed with his parents to Middletown, CT in 1746 and after his marriage in 1757, lived on a farm just west of Pocotapaug lake in E. Hampton.

! In 1780 he was of committee appointed to provide necessities for the Continental army and assisted in provisioning troops on L.I. narrowly escaping capture at one time.

! In 1794 he purchased land in Freehold, Albany Co., NY being part of the town ship sold to Benj. Spees et al., of Chatham, called "Lothania, of Maitland claim," the consideration therefor being £60.

! 9 May 1778, he deeded land in E. Hampton to his son Isaac, and in 1795, another parcel to his son Willard.

! "Many personal anecdotes are related of him. He was a man of large frame, tall and muscular, with a mind fitted for the body it inhabited, filled with a spirit of enterprise, and reckless of danger. After the War of the Revolution broke out, he equipped a vessel which he commanded himself, and which preyed on British convoys. His vessel was captured by a British ship, and he, with one of his men, were made prisoner and confined on board. From what he heard and saw, he suspected that preparations were making for their summary execution in the morning. He expressed his suspicions to his man, and prepared to escape and swim ashore. His man thought the attempt desperate, but Sears replied: 'I would rather trust my neck in the water than the rope.' About midnight they eluded the sleepy guard, and let themselves down into the water, but were soon discovered, and fired upon from the ship. Sears reached the shore, but his man gave out. He took a boat, went out and picked him up, and both escaped in safety. Nothing daunted by his hairbreadth escape, he went to work immediately to fit out another vessel.

! "After the war he became actively engaged in mechanical and agricultural pursuits.

! He died of apoplexy on Sunday morning, 24 Nov 1816, ae 83. He was greatly beloved, and his funeral was largely attended, his body was born to the grave, on a bier carried by four of his old neighbors.

!

! In his will he devised to his children some \$15,000.

! His house stood till 1848, when it was taken down.

!

!RESIDENCE: Index, 1790 Fed Census, Middlesex Co CT; 1790; Accelerated Indexing Systems; p 81; OKC Hist Soc; Chatham Town; 2 adult males, 2 females; listed next to Isaac and Willard. Ebenezer and David also listed in Chatham Town.

!

!Mayflower Index: No. 29,940 and 29,941 Elkanah; spouse Ruth White; both parents MD

!

!DAR # 64156 in 1777 a member of a committee to provide necessities for the Continental Army and commanded a vessel, which he equipped himself, to prey upon the British convoys.

!

!http://freepages.genealogy.rootsweb.com/~jdevlin/town_hist/chatham_1884_hist.htm

!

!History of Middlesex Co, Town of Chatham

At a Town Meeting Held in Chatham by the Inhabitants of said Town * * September ye 30 AD 1777 * *

Voted by this meeting that the Soldiers Inlisted into the Continental army Shall Be provided with Necessarys agreeable To he Resove (?) of the Governor and Counsel of Safty Held in Lebenon the 12th of

⁶² Ancestry.com, 1790 United States Federal Census (Provo, UT, USA, Ancestry.com Operations, Inc., 2010), Ancestry.com, Year: 1790; Census Place: Chatham, Middlesex, Connecticut; Series: M637; Roll: 1; Page: 435; Image: 378; Family History Library Film: 0568141.
[Source citation includes one media item]

⁶³ Ancestry.com, Connecticut, Town Marriage Records, pre-1870 (Barbour Collection) (Provo, UT, USA, Ancestry.com Operations Inc, 2006), Ancestry.com.
[Source citation includes one media item]

⁶⁴ Hatcher, Patricia Law, Abstract of Graves of Revolutionary Patriots (Provo, UT, USA, Ancestry.com Operations Inc, 1999), Ancestry.com, Abstract of Graves of Revolutionary Patriots; Volume: 4; Page: 17; Serial: 11999; Volume: 8.

Sep. 1777.

!"Voted that there Should be a Commite Chosen and appointed in Each Parish of sd. Town To procure Said Necessarys above mentioned.

!"Chosen as said Com'tee in the first Society Joseph Sage Hezekiah Goodrich Thomas Cooper Lt. Noadiah Russel Capt. Joseph Churchel Elisha Shepard Jesse Johnson Joshua Goodrich Nicholas Ames John Ufford & William Dixon & Jeremiah Goodrich.!"In Middlehaddam Elisha Taylor Capt Joseph Dart Enoch Smith Josiah Strong Chancy Bulkley John Giddings Hershom Rowley Benj'n Smith Hezekiah Sears Elisha Hurlbut Sam'el Young Lemuel Higgins and Jonathan Smith Jun.

!"In East Hampton John Hinkley John Bates Benj'n Gogg Elkanah Sears Isaac Kneeland Thomas Cowdery Stephen Brainard & John Clark Jr. "Whereas the Town of Chatham Having Twenty nine Bushel and an half of Salt Stored in the Town of Boston voted by this Meeting that Said Salt Shall be Distributed To the Continental Soldiers Belonging To Chatham at the former Stated price.

!

!NEHGS Cemetery records SEARS, Elkanah[3266] East Hampton Cem East Hampton CT 56 Abstract of Graves of Revolutionary Patriots, Vol.4, p.17 -Serial: 11999; Volume: 8

Lynne Korszniak Sears As my husband's family tells it, Capt Elkanah Sears was considered a pirate by the British but considered a privateer by his friends. :-) (that would be Richard, Paul, Paul, Joshua, ELKANAH) He was captured but escaped before he could be executed.

More facts and events for Elkanah Sears:

Residence: 1790 Chatham{ XE "USA, Connecticut, Middlesex, Chatham: :Sears, Elkanah (1734-1816)" \f "Place" }^[62]

Residence: 1810 Chatham{ XE "USA, Connecticut, Middlesex, Chatham: :Sears, Elkanah (1734-1816)" \f "Place" }^[61]

- 18.** Elkanah married **Ruth White**{ XE "White:Ruth (1733-1823)" \f "Name" \b \i } on Thursday, 6th January 1757, in Middletown{ XE "USA, Connecticut, Middlesex, Middletown:(41.5623° N, 72.6506° W):Sears, Elkanah (1734-1816)" \f "Place" }^[55, 57, 59, 63] They had six children: Isaac (1757-1842), Willard (1760-1838), Ruth (1762-1764), Ruth (1765-1830), Rachel (1768-1850) and Benjamin (1771-1822).

Ruth was born in Middletown{ XE "USA, Connecticut, Middlesex, Middletown:(41.5623° N, 72.6506° W):White, Ruth (1733-1823)" \f "Place" } in 1733.^[55, 57, 59] She reached 90 years of age and died in East Hampton{ XE "USA, Connecticut, Middlesex, East Hampton:(41.5759° N, 72.5026° W):White, Ruth (1733-1823)" \f "Place" } on 9th March 1823.^[55, 57, 59] Ruth was buried in East Hampton{ XE "USA, Connecticut, Middlesex, East Hampton:(41.5759° N, 72.5026° W):White, Ruth (1733-1823)" \f "Place" }^[59].

Children of Elkanah Sears and Ruth White:

- + 30 m I. **Isaac⁴ Sears**{ XE "Sears:Isaac (1757-1842)" \f "Name" } was born in Chatham{ XE "USA, Connecticut, Middlesex, Chatham: :Sears, Isaac (1757-1842)" \f "Place" } on 3rd November 1757.^[65] He died in New Durham, New York,{ XE "USA, New York, New Durham: :Sears, Isaac (1757-1842)" \f "Place" } in 1842 at the age of 84.
- + 32 m II. **Willard Sears**{ XE "Sears:Willard (1760-1838)" \f "Name" } was born in Chatham{ XE "USA, Connecticut, Middlesex, Chatham: :Sears, Willard (1760-1838)" \f "Place" } on 8th September 1760.^[59, 66, 67] He died in East Hampton{ XE "USA, Connecticut, Middlesex, East Hampton:(41.5759° N, 72.5026° W):Sears, Willard (1760-1838)" \f "Place" } on 23rd August 1838, at the age of 77.^[59, 60, 66, 67]
- f III. **Ruth Sears**{ XE "Sears:Ruth (1762-1764)" \f "Name" \b } was born in Middletown{ XE "USA, Connecticut, Middlesex, Middletown:(41.5623° N, 72.6506° W):Sears, Ruth (1762-1764)" \f "Place" } on 13th March 1762. She died in Middletown{ XE "USA, Connecticut, Middlesex, Middletown:(41.5623° N, 72.6506° W):Sears, Ruth (1762-1764)" \f "Place" } on 29th July 1764, at the age of 2.

⁶⁵ Ancestry.com, Connecticut Town Birth Records, pre-1870 (Barbour Collection) (Provo, UT, USA, Ancestry.com Operations Inc, 2006), Ancestry.com.

⁶⁶ Ancestry.com, U.S., Sons of the American Revolution Membership Applications, 1889-1970 (Provo, UT, USA, Ancestry.com Operations, Inc., 2011), Ancestry.com, Volume: 96.

⁶⁷ Ancestry.com, U.S., Sons of the American Revolution Membership Applications, 1889-1970 (Provo, UT, USA, Ancestry.com Operations, Inc., 2011), Ancestry.com, Volume: 62.

- + 35 f IV. **Ruth Sears**{ XE "Sears:Ruth (1765–1830)" \f "Name" } was born in Easthampton, Hampshire, Massachusetts,{ XE "USA, Massachusetts, Hampshire, Easthampton:(42.2668° N, 72.669° W):Sears, Ruth (1765–1830)" \f "Place" } on 21st March 1765. She died in Meredith, Delaware, New York,{ XE "USA, New York, Delaware, Meredith:(42.3583° N, 74.9348° W):Sears, Ruth (1765–1830)" \f "Place" } in 1830 at the age of 64.
- + 37 f V. **Rachel Sears**{ XE "Sears:Rachel (1768–1850)" \f "Name" } was born in East Hampton, Middlesex, Connecticut,{ XE "USA, Connecticut, Middlesex, East Hampton:(41.5759° N, 72.5026° W):Sears, Rachel (1768–1850)" \f "Place" } on 9th September 1768. She died on 19th September 1850, at the age of 82.
- + 39 m VI. **Benjamin Sears**{ XE "Sears:Benjamin (1771–1822)" \f "Name" } was born in Chatham{ XE "USA, Connecticut, Middlesex, Chatham: :Sears, Benjamin (1771–1822)" \f "Place" } on 21st February 1771.^[55, 57, 59, 60, 65, 68] He died in Delaware, Ohio,{ XE "USA, Ohio, Delaware:(40.2783° N, 83.0074° W):Sears, Benjamin (1771–1822)" \f "Place" } on 11th October 1822, at the age of 51.^[55, 57, 59, 68]

Family of Betsy Sears and Samuel Hitchcock{ TC "Betsy Sears and Samuel Hitchcock" \I 3 \f C}

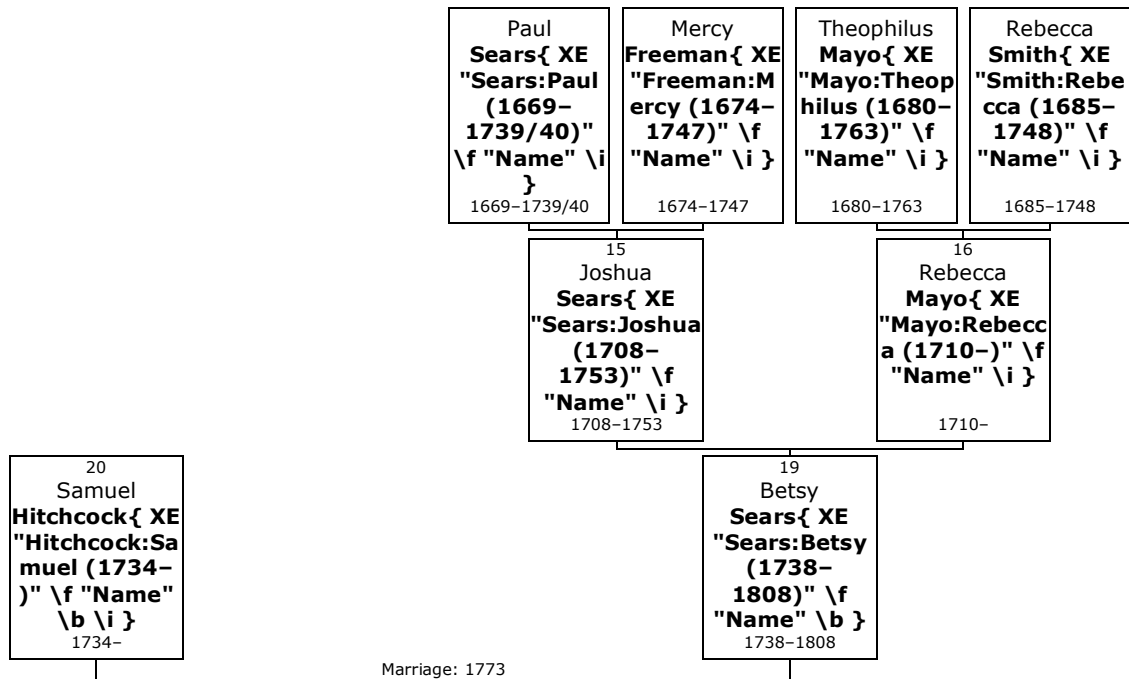

19. **Betsy³ Sears**{ XE "Sears:Betsy (1738–1808)" \f "Name" \b } (*Joshua*²) was born on 19th June 1738, in Harwich, Barnstable, Massachusetts, USA{ XE "USA, Massachusetts, Barnstable, Harwich:(41.6862° N, 70.0758° W):Sears, Betsy (1738–1808)" \f "Place" }. She was the daughter of Joshua Sears{ XE "Sears:Joshua (1708–1753)" \f "Name" \i } (15) and Rebecca Mayo{ XE "Mayo:Rebecca (1710–)" \f "Name" \i } (16).

Betsy was christened on 24th June 1739. She died in 1808 at the age of 69.

!S.P. May p.84, No 200, b., m. 14 Jun 1798, Elizh Hitchcock et ux., signed deeds to Elkanah Sears of Middletown, CT. Harwich VR p. 67 [Vol I p. 228]b. Betsy

20. Betsy married **Samuel Hitchcock**{ XE "Hitchcock:Samuel (1734–)" \f "Name" \b \i } on Wednesday, 20th October 1773. They had no known children.

Samuel was born in New Marlborough, Berkshire,{ XE "USA, Massachusetts, Berkshire, New Marlborough:(42.1229° N, 73.2287° W):Hitchcock, Samuel (1734–)" \f "Place" } in 1734.

⁶⁸ Ancestry.com, Web: Ohio, Find A Grave Index, 1787-2012 (Provo, UT, USA, Ancestry.com Operations, Inc., 2012), Ancestry.com.

Paul Sears{ TC "Paul Sears" \I 3 \f C}

21. Paul³ Sears{ XE "Sears:Paul (1740-1832)" \f "Name" \b } (*Joshua*²) was born on 18th October 1740, in Harwich, Barnstable, Massachusetts, USA{ XE "USA, Massachusetts, Barnstable, Harwich:(41.6862° N, 70.0758° W):Sears, Paul (1740-1832)" \f "Place" }.^[69] He was the son of Joshua Sears{ XE "Sears:Joshua (1708-1753)" \f "Name" \i } (15) and Rebecca Mayo{ XE "Mayo:Rebecca (1710-)" \f "Name" \i } (16).

Paul was christened on 2nd November 1740. He died in Sandisfield, Berkshire,{ XE "USA, Massachusetts, Berkshire, Sandisfield:(42.1126° N, 73.1432° W):Sears, Paul (1740-1832)" \f "Place" } on 19th August 1832, at the age of 91.^[69, 70] Paul was buried in Sandisfield{ XE "USA, Massachusetts, Berkshire, Sandisfield:(42.1126° N, 73.1432° W):Sears, Paul (1740-1832)" \f "Place" }.^[69]

!Harwich VR p. 67 [Vol I p. 228]b.

Wikitree-3193

!

!S.P. May No. 201, p.138 Paul removed with his parents to Middletown, CT and was one of the earliest settlers of Sandisfield, MA.,

!

!Mayflower Index: No. 30,001 Paul; spouse Elizabeth Slawter; father Joshua

!

!DAR app says he served as a corporal in the Berkshire county militia, to reinforce the northern army, 1777

!

!SEARS, Paul Sr Sandisfield Cem Sandisfield MA 45 Abstract of Graves of Revolutionary Patriots, Vol.4, p. -Serial: 10950; Volume: 13

U.S., Sons of the American Revolution Membership Applications, 1889-1970 about Rebecca Mays SAR Membership: 61912 Birth Date: 10 Oct 1713 Spouse: Joshua Sears Children: Paul Sears

Marriages with Mrs Lydia (Lyon) Knight and Elizabeth Slawter (Page 50) are known.

Family of Paul Sears and Lydia Knight{ TC "Paul Sears and Lydia Knight" \I 4 \f C}

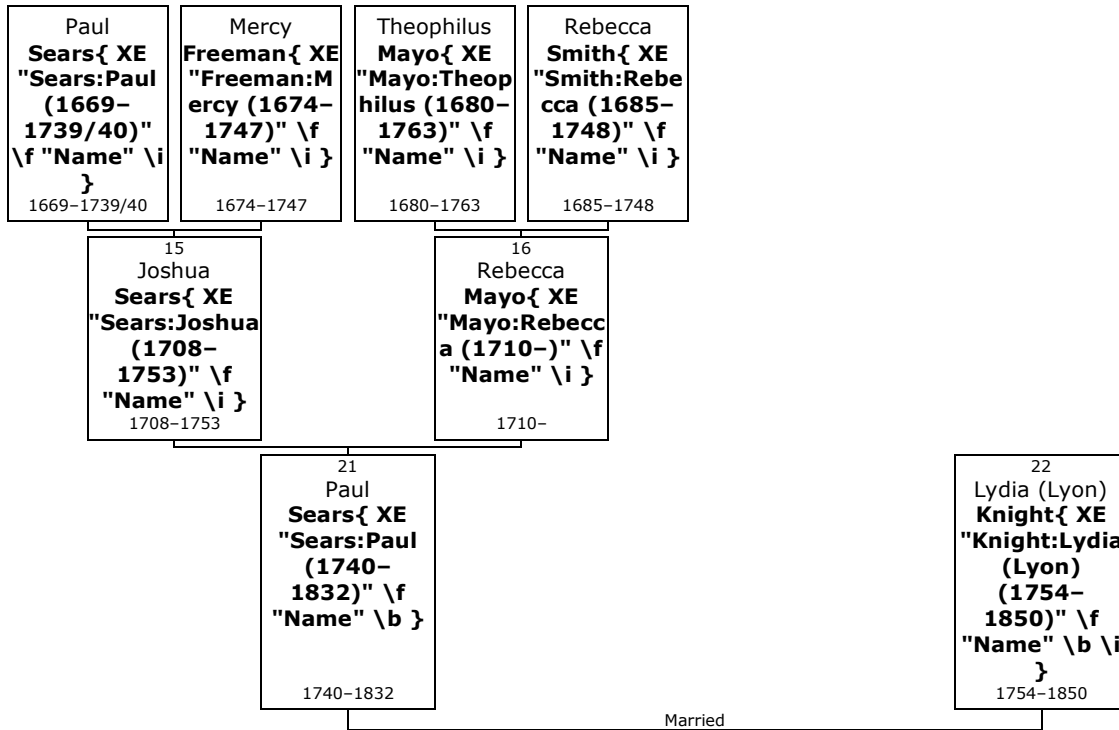

Here are the details about **Paul Sears**{ XE "Sears:Paul (1740-1832)" \f "Name" \b } first marriage, with Mrs Lydia (Lyon) Knight. You can read more about Paul on page 49.

⁶⁹ Ancestry.com, U.S., Find A Grave Index, 1600s-Current (Provo, UT, USA, Ancestry.com Operations, Inc., 2012), Ancestry.com.

⁷⁰ Centennial Edition, Part 3, Page 2601, DAR Patriot Index.

22. Paul Sears married **Mrs Lydia (Lyon) Knight**{ XE "Knight:Lydia (Lyon) (1754–1850)" \f "Name" \b \i }.^[69] They had no known children.

Lydia (Lyon) was born in perh, Harwich,{ XE "USA, Massachusetts, Barnstable, Harwich, perh: :Knight, Lydia (Lyon) (1754–1850)" \f "Place" } in 1754.^[69] She reached 96 years of age and died in Sandisfield, Berkshire,{ XE "USA, Massachusetts, Berkshire, Sandisfield:(42.1126° N, 73.1432° W):Knight, Lydia (Lyon) (1754–1850)" \f "Place" } on 28th March 1850.^[69] Lydia (Lyon) was buried in Sandisfield{ XE "USA, Massachusetts, Berkshire, Sandisfield:(42.1126° N, 73.1432° W):Knight, Lydia (Lyon) (1754–1850)" \f "Place" }.^[69]

Family of Paul Sears and Elizabeth Slawter{ TC "Paul Sears and Elizabeth Slawter" \I 4 \f C}

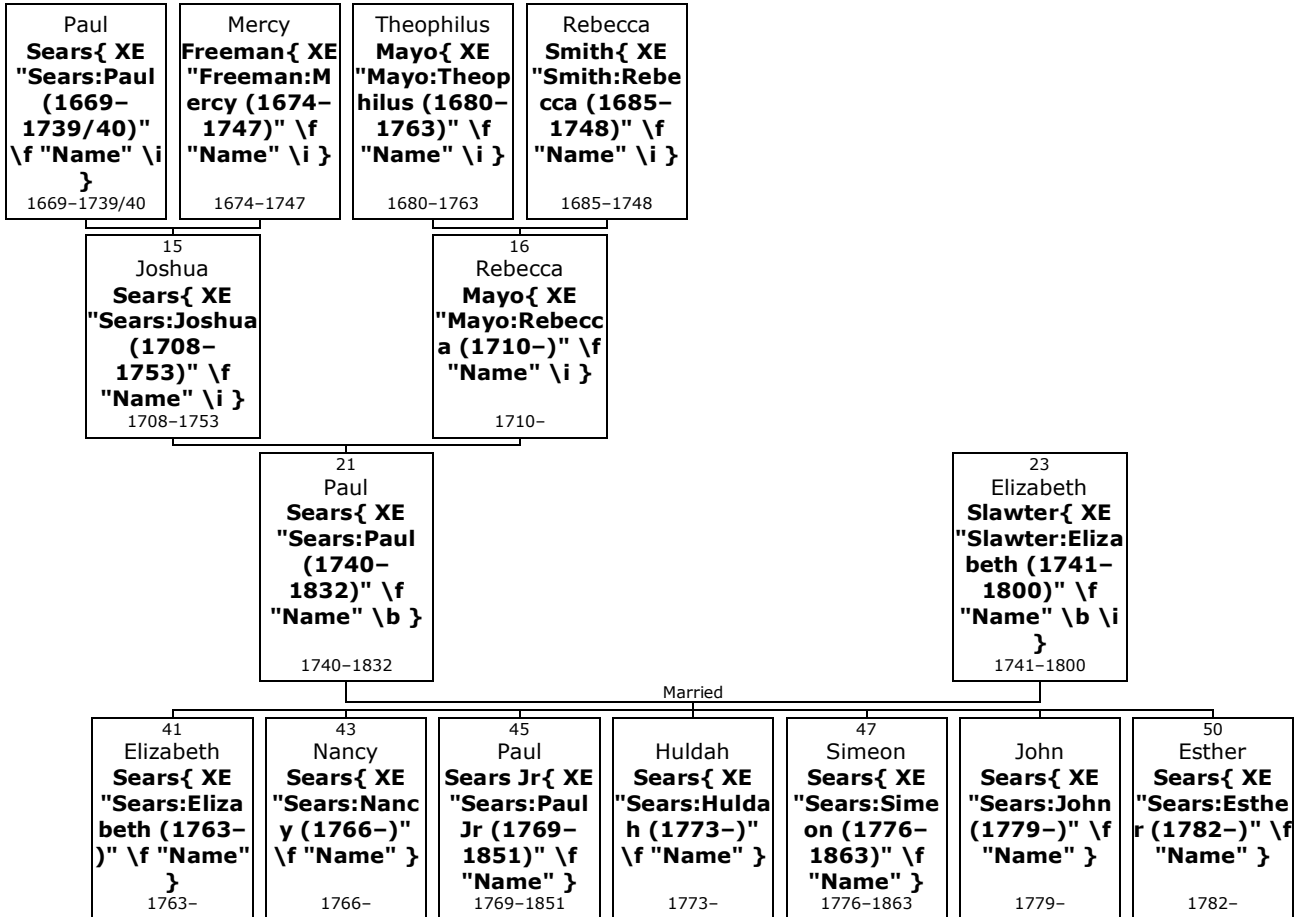

Here are the details about **Paul Sears**{ XE "Sears:Paul (1740–1832)" \f "Name" \b } second marriage, with Elizabeth Slawter. You can read more about Paul on page 49.

23. Paul Sears married **Elizabeth Slawter**{ XE "Slawter:Elizabeth (1741–1800)" \f "Name" \b \i }. They had seven children: Elizabeth (1763–), Nancy (1766–), Paul (1769–1851), Huldah (1773–), Simeon (1776–1863), John (1779–) and Esther (1782–).

Elizabeth was born in Simsbury, Hartford, Connecticut,{ XE "USA, Connecticut, Hartford, Simsbury:(41.8758° N, 72.8017° W):Slawter, Elizabeth (1741–1800)" \f "Place" } in 1741. She reached 59 years of age and died on 18th July 1800.

DEATH: CarDel Scribe: Vol 20 No 4, p 29 Jul 83 Queries; poss d. MA or CT

Children of Paul Sears and Elizabeth Slawter:

- + 41 f I. **Elizabeth^d Sears**{ XE "Sears:Elizabeth (1763–)" \f "Name" } was born in Sandisfield, Berkshire, Massachusetts,{ XE "USA, Massachusetts, Berkshire, Sandisfield:(42.1126° N, 73.1432° W):Sears, Elizabeth (1763–)" \f "Place" } on 16th February 1763.
- + 43 f II. **Nancy Sears**{ XE "Sears:Nancy (1766–)" \f "Name" } was born in Sandisfield{ XE "USA, Massachusetts, Berkshire, Sandisfield:(42.1126° N, 73.1432° W):Sears, Nancy (1766–)" \f "Place" } on 12th November 1766.

-
- + 45 m III. **Paul Sears Jr**{ XE "Sears:Paul Jr (1769–1851)" \f "Name" } was born in Sandisfield{ XE "USA, Massachusetts, Berkshire, Sandisfield:(42.1126° N, 73.1432° W):Sears, Paul Jr (1769–1851)" \f "Place" } on 2nd February 1769.^[69] He died in Sandisfield, Berkshire County,{ XE "USA, Massachusetts, Berkshire County, Sandisfield:(42.1126° N, 73.1432° W):Sears, Paul Jr (1769–1851)" \f "Place" } on 25th September 1851, at the age of 82.^[69]
- f IV. **Huldah Sears**{ XE "Sears:Huldah (1773–)" \f "Name" \b } was born in Sandisfield{ XE "USA, Massachusetts, Berkshire, Sandisfield:(42.1126° N, 73.1432° W):Sears, Huldah (1773–)" \f "Place" } on 22nd October 1773.
- + 47 m V. **Simeon Sears**{ XE "Sears:Simeon (1776–1863)" \f "Name" } was born in Sandisfield{ XE "USA, Massachusetts, Berkshire, Sandisfield:(42.1126° N, 73.1432° W):Sears, Simeon (1776–1863)" \f "Place" } on 7th October 1776.^[69, 71] He died in Pennsylvania{ XE "USA, Pennsylvania:(40.8583° N, 76.3834° W):Sears, Simeon (1776–1863)" \f "Place" } on 23rd December 1863, at the age of 87.^[69]
- m VI. **John Sears**{ XE "Sears:John (1779–)" \f "Name" \b } was born in Sandisfield{ XE "USA, Massachusetts, Berkshire, Sandisfield:(42.1126° N, 73.1432° W):Sears, John (1779–)" \f "Place" } on 9th November 1779.
- + 50 f VII. **Esther Sears**{ XE "Sears:Esther (1782–)" \f "Name" } was born in Sandisfield{ XE "USA, Massachusetts, Berkshire, Sandisfield:(42.1126° N, 73.1432° W):Sears, Esther (1782–)" \f "Place" } on 23rd June 1782.

⁷¹ Ancestry.com, Massachusetts, Town and Vital Records, 1620-1988 (Provo, UT, USA, Ancestry.com Operations, Inc., 2011), Ancestry.com.

Family of Simeon Sears and Sarah --Sears{ TC "Simeon Sears and Sarah --Sears" \I 3 \f C}

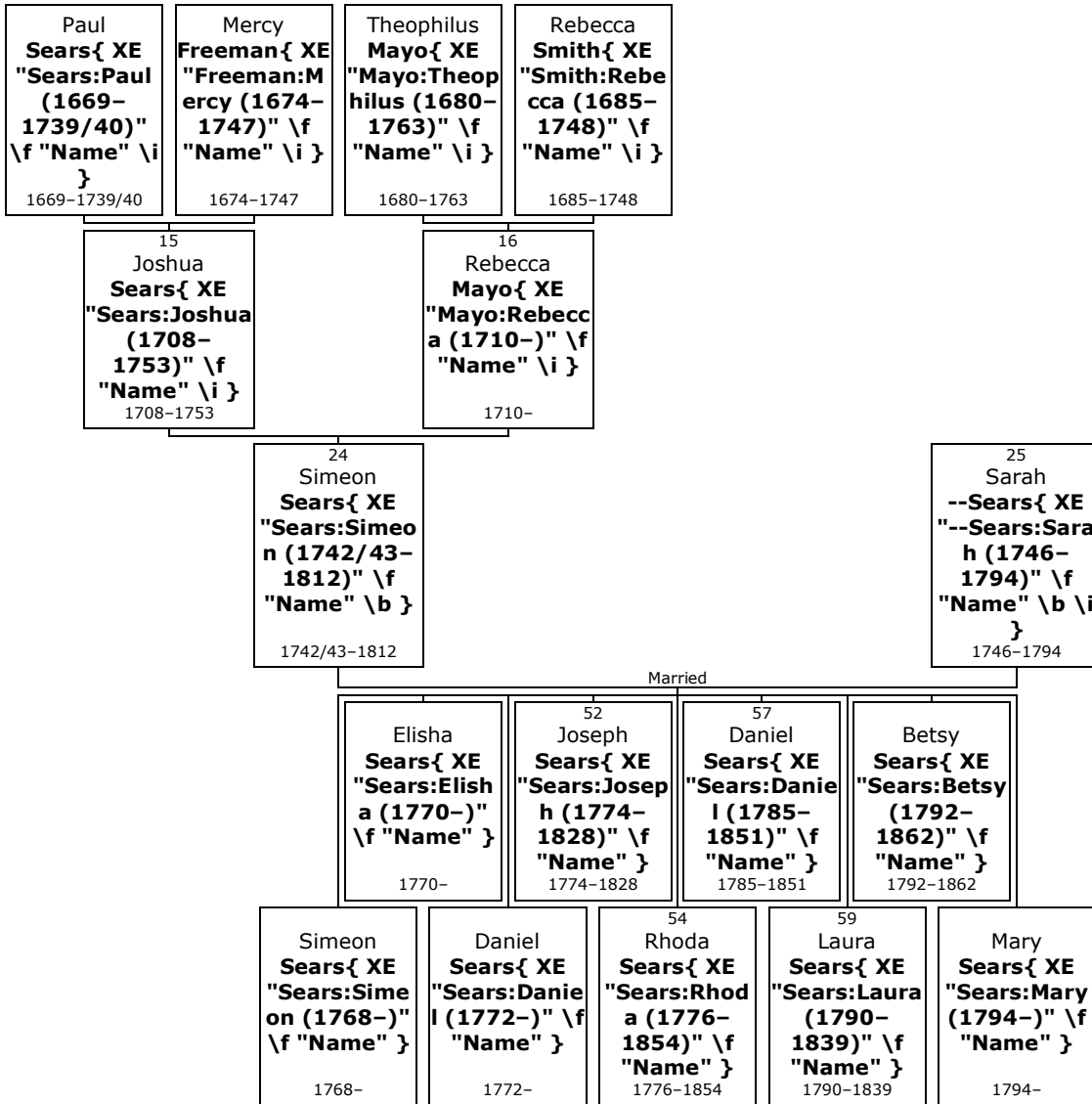

24. **Simeon³ Sears**{ XE "Sears:Simeon (1742/43-1812)" \f "Name" \b } (*Joshua*²) was born on 14th January 1742/43, in Harwich, Barnstable, Massachusetts, USA{ XE "USA, Massachusetts, Barnstable, Harwich:(41.6862° N, 70.0758° W):Sears, Simeon (1742/43-1812)" \f "Place" }. He was the son of Joshua Sears{ XE "Sears:Joshua (1708-1753)" \f "Name" \i } (15) and Rebecca Mayo{ XE "Mayo:Rebecca (1710-)" \f "Name" \i } (16).

Simeon was christened on 16th January 1742/43. He died in 1812 at the age of 68.

<https://www.wikitree.com/wiki/Sears-3026>

!Harwich VR p. 67 [Vol I p. 228]b.

!

!S.P. May No 202 p.139 Simeon Sears removed to Sandisfield, MA, and thence to Bennington, NY (now VT) where his name appears in list of original members at the organization of the 1st Ch., 3 Dec 1762. He perhaps returned to Sandisfield as a deed to his bro. Elkanah is dated there in Oct 1765. 20 Oct 1773, in deed to Elkanah, he calls himself of "Rheuport,"(Rupert, VT) and his name is found there on town records, 12 Dec 1768. 24 Dec 1773, he gives his residence as Suffield, Hartford Co., CT. 17 Oct 1780, he hails from Bennington, NY (now VT).

!

Removed notes-(possib the wrong Simeon?)--He was in Capt (afterward Col.)Robinson's company at the battle of Bennington, Aug. 16, 1777--

Removed notes (possib the wrong Simeon) ! He bought a section of land in northern Vermont, with the intention of removing, but died without carrying out his purpose. ! His sons, Simeon and Elisha, were large dealers in horses, buying colts in Canada, keeping them in Vermont till maturity, and then shipping them to the West Indies.

!

! May's handnotes addition: ! Simeon Sears of Waterbury, served in Col. Canfields Regt at West Point, Sep 1781.

!

!Capt Simeon Sears was appointed Vendue-master, at a sale of "plunder" held at Battenkill, 18 Oct 1777, (two months after the battle of Bennington). He bid in a sword for £3.18.0. Where the "plunder" was obtained was not quite clear.

! There was a large amount of dry goods, watches, knives and clothing, which sold for £298.1.6. C.C. Coffin in his history of Biscawen, p.265, says "He was undoubtedly Capt Sears of Bennington." R H Secrist wife?

Massachusetts, Town and Vital Records, 1620-1988 about Simeon Sears Event Type: Birth Birth Date: 14 Jan 1742 Birth Place: Harwich, Massachusetts Father Name: Joshua Sears Mother Name: Rebakah

!

!American Genealogical-Biographical Index (AGBI) about Simeon Sears Birth Date: 1742 Birthplace: Massachusetts Volume: 155 Page Number: 372 Reference: Gen. Column of the " Boston Transcript". 1906-1941.(The greatest single source of material for gen. Data for the N.E. area and for the period 1600-1800. Completely indexed in the Index.): 16 Dec 1907, 9574

!

!Massachusetts, Town and Vital Records, 1620-1988 about Simeon Sears Event Type: Birth Birth Date: 14 Jan 1742 Birth Place: Harwich, Massachusetts Father Name: Joshua Sears Mother Name: Rebecca Sears Massachusetts, Town and Vital Records, 1620-1988 about Simeon Sears Event Type: Birth Birth Date: 14 Jan 1742 Birth Place: Harwich, Massachusetts Father Name: Joshua Sears Mother Name: Rebakah Sears

25. He married **Sarah --Sears**{ XE "--Sears:Sarah (1746-1794)" \f "Name" \b \i }. They had nine children: Simeon (1768-), Elisha (1770-), Daniel (1772-), Joseph (1774-1828), Rhoda (1776-1854), Daniel (1785-1851), Laura (1790-1839), Betsy (1792-1862) and Mary (1794-).

Sarah was born in perh, Bennington, Vermont,{ XE "USA, Vermont, Bennington, perh: :--Sears, Sarah (1746-1794)" \f "Place" } in 1746. She reached 48 years of age and died in perh, Pownal,{ XE "USA, Vermont, Bennington, Pownal, perh: :--Sears, Sarah (1746-1794)" \f "Place" } in March 1794.

Tryphena Hurlburt is Not the Spouse of This Simeon Sears kjsearsadded this on 9 May 2012 The spouse of Simeon Sears of Bennington, Rupert, Pawlet and Powney VT was Sarah, maiden name unknown. She is named both in Simeon's will of Jan 1794, and in the probate records of March, 1794, following the death of Simeon in Powney, VT NOT -- possib Mary "Polly" Hulbert is second wife (see his nephew Deacon Simeon Sears)[4901], and Sarah ___ is the mother of these children

Children of Simeon Sears and Sarah --Sears:

- m I. **Simeon⁴ Sears**{ XE "Sears:Simeon (1768-)" \f "Name" \b } was born in perh{ XE "USA, Vermont, Bennington, perh: :Sears, Simeon (1768-)" \f "Place" } in 1768.
- m II. **Elisha Sears**{ XE "Sears:Elisha (1770-)" \f "Name" \b } was born in perh{ XE "USA, Vermont, Bennington, perh: :Sears, Elisha (1770-)" \f "Place" } in 1770.
- m III. **Daniel Sears**{ XE "Sears:Daniel (1772-)" \f "Name" \b } was born in perh{ XE "USA, Vermont, Bennington, perh: :Sears, Daniel (1772-)" \f "Place" } in 1772.
- + 52 m IV. **Joseph Sears**{ XE "Sears:Joseph (1774-1828)" \f "Name" } was born in perh{ XE "USA, Vermont, Bennington, perh: :Sears, Joseph (1774-1828)" \f "Place" } in 1774. He died in Shawneetown, Gallatin, Illinois,{ XE "USA, Illinois, Gallatin, Shawneetown:(37.7131° N, 88.1867° W):Sears, Joseph (1774-1828)" \f "Place" } in 1828 at the age of 54.
- + 54 f V. **Rhoda Sears**{ XE "Sears:Rhoda (1776-1854)" \f "Name" } was born in Bennington{ XE "USA, Vermont, Bennington:(43.0293° N, 73.1084° W):Sears, Rhoda (1776-1854)" \f "Place" } in 1776. She died in Pawlet, Rutland,{ XE "USA, Vermont, Rutland, Pawlet:(43.3467° N, 73.1767° W):Sears, Rhoda (1776-1854)" \f "Place" } on 6th January 1854, at the age of 78.
- + 57 m VI. **Daniel Sears**{ XE "Sears:Daniel (1785-1851)" \f "Name" } was born in Vermont{ XE "USA, Vermont:(43.8726° N, 71.55° W):Sears, Daniel (1785-1851)" \f "Place" } in

1785.^[72] He was also known as **David Sears**{ XE "Sears:David (Daniel Sears) (1785–1851)" \f "Name" }.^[72]

Daniel died in St Lawrence, New York,{ XE "USA, New York, St Lawrence:(44.5785° N, 75.2597° W):Sears, Daniel (1785–1851)" \f "Place" } in 1851 at the age of 66.

- + 59 f VII. **Laura Sears**{ XE "Sears:Laura (1790–1839)" \f "Name" } was born in Pawlet, Rutland, Vermont,{ XE "USA, Vermont, Rutland, Pawlet:(43.3467° N, 73.1767° W):Sears, Laura (1790–1839)" \f "Place" } on 24th March 1790.^[73] She died on 6th March 1839, at the age of 48.^[73]
- f VIII. **Betsy Sears**{ XE "Sears:Betsy (1792–1862)" \f "Name" \b } was born in perh, Pawlet,{ XE "USA, Vermont, Rutland, Pawlet, perh: :Sears, Betsy (1792–1862)" \f "Place" } in 1792. She died in 1862 at the age of 70.
- f IX. **Mary Sears**{ XE "Sears:Mary (1794–)" \f "Name" \b } was born in perh{ XE "USA, Vermont, Rutland, Pawlet, perh: :Sears, Mary (1794–)" \f "Place" } in 1794.

Family of Sarah Sears and Samuel Hitchcock{ TC "Sarah Sears and Samuel Hitchcock" \I 3 \f C}

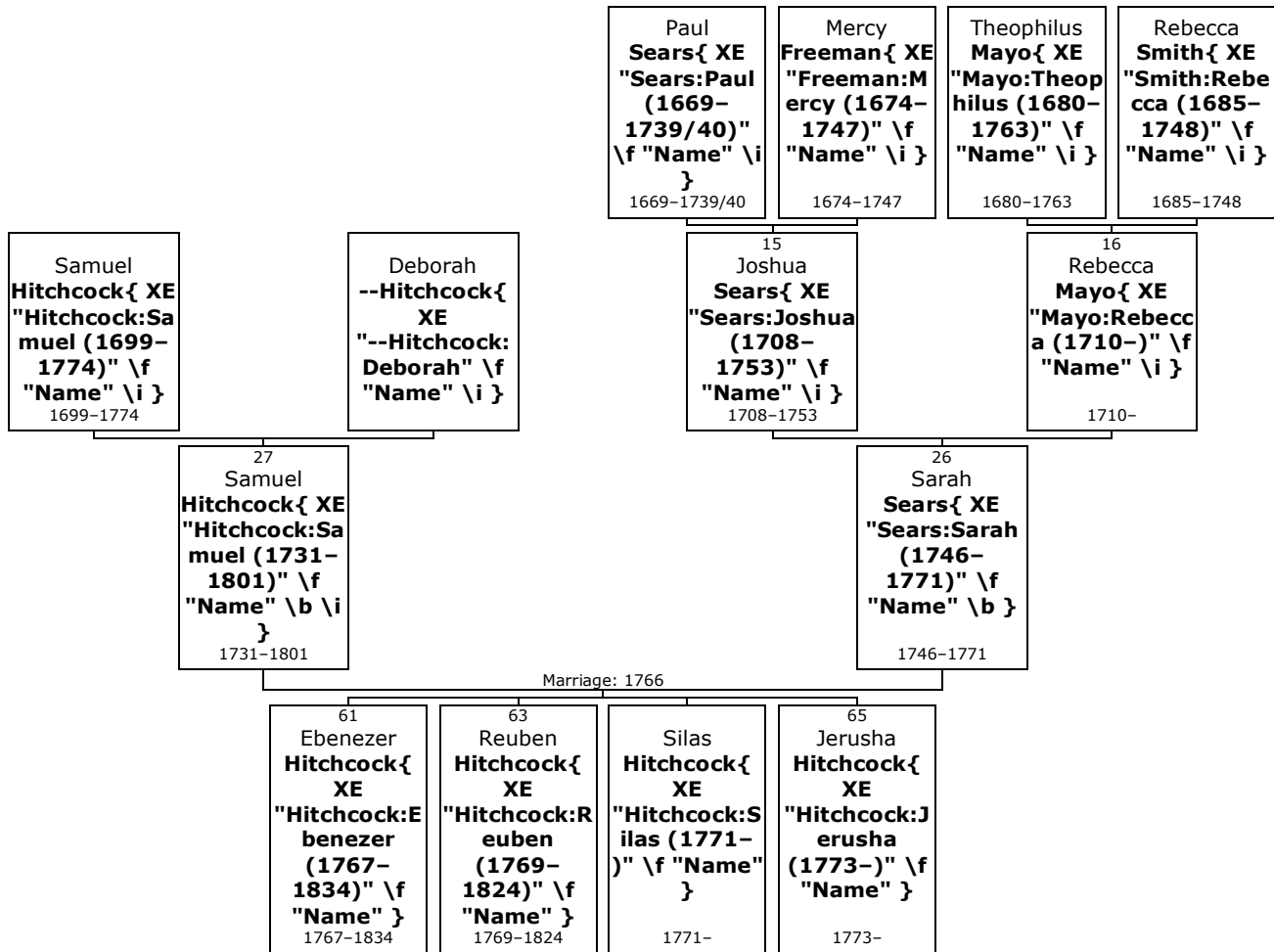

26. **Sarah³ Sears**{ XE "Sears:Sarah (1746–1771)" \f "Name" \b } (*Joshua*²) was born in 1746 in perh, Harwich, Barnstable, Massachusetts, USA{ XE "USA, Massachusetts, Barnstable, Harwich, perh: :Sears, Sarah (1746–1771)" \f "Place" }. She was the daughter of Joshua Sears{ XE "Sears:Joshua (1708–1753)" \f "Name" \i } (15) and Rebecca Mayo{ XE "Mayo:Rebecca (1710–)" \f "Name" \i } (16).

⁷² Ancestry.com, 1850 United States Federal Census (Provo, UT, USA, Ancestry.com Operations, Inc., 2009), Ancestry.com, Year: 1850; Census Place: Gouverneur, Saint Lawrence, New York; Roll: M432_589; Page: 194B; Image: 396. Record for Daniel Sears. <http://search.ancestry.com/cgi-bin/sse.dll?db=8054&h=8268369&indiv=try>.

⁷³ "Ancestry Family Tree", Record for Ephraim Fitch CURTISS. <http://search.ancestry.com/cgi-bin/sse.dll?db=1030&h=13278591617&indiv=try>.

Sarah died in New Marlborough, Berkshire, { XE "USA, Massachusetts, Berkshire, New Marlborough:(42.1229° N, 73.2287° W):Sears, Sarah (1746–1771)" \f "Place" } on 27th March 1771, at the age of 25.

not listed in Harwich VR with births of siblings
!S P May, p 84, No 204

<https://www.wikitree.com/index.php?title=Sears-4165>

From: sears-bounces@rootsweb.com [mailto:sears-bounces@rootsweb.com] On Behalf Of Buch419@aol.com Sent: Monday, April 23, 2012 7:08 PM
To: john@jytangledweb.org; sears@rootsweb.com Subject: [SEARS] Sears Cemetery Yes, it is! Thank you. It was so hard to find (knocking on house door and asking if we could walk around, etc.) that I never even thought about it being on findagrave. I will have to go back and check my notes and pictures. It has been several years. I have been doing research off and on for 10 years trying to get enough data to reprove my great-grandmother's Mayflower Society application - just to do it! But I can not get past Sarah Sears, daughter of Joshua and Rebecca Mayo. First, she is one of only 2 of 12 children by this couple that doesn't have a baptismal date. But I assume she was born about 1746 - while they were on their way or just arriving in CT. Then she probably married Samuel Hitchcock about 1766 - had three children (no records of their births anyplace). She died probably about 1771, shortly after her daughter, my 4xgreat-grandmother was born. Then Samuel eventually married her sister, Betsy, and they had one more son. Betsy has a baptismal date in Brewster. NO birth/death/burial/marriage records for Sarah. She is mentioned in the Sears book as marrying a _____ Hitchcock. Betsy is noted as marrying Samuel Hitchcock. Samuel was a Rev. War soldier - no marriage records/death or burial for him even though he died in New Marlborough, Berkshire, MA in 1801, probably in Feb. In the Hitchcock book (I have both of these mentioned books) - It gives his four children, no wife. I think the last two children are out of order. Jerusha came before Silas. And had different mothers. I could go on and on. I have a 12 page research log, etc. I am really at a loss as to where to go next. Most frustrating. Sorry, didn't mean to get started on this. I will check my records for pics and let you know what I find. Thank you - Janet Buchanan

27. Sarah married **Samuel Hitchcock**{ XE "Hitchcock:Samuel (1731–1801)" \f "Name" \b \i } in 1766 in Middletown, Middlesex, Connecticut{ XE "USA, Connecticut, Middlesex, Middletown:(41.5623° N, 72.6506° W):Sears, Sarah (1746–1771)" \f "Place" }.^[74, 75] They had four children: Ebenezer (1767–1834), Reuben (1769–1824), Silas (1771–) and Jerusha (1773–).

Samuel was born in New Milford, Litchfield, { XE "USA, Connecticut, Litchfield, New Milford:(41.577° N, 73.4084° W):Hitchcock, Samuel (1731–1801)" \f "Place" } on 28th February 1731.^[74, 75] He was the son of Samuel Hitchcock{ XE "Hitchcock:Samuel (1699–1774)" \f "Name" \i } and Deborah --Hitchcock{ XE "--Hitchcock:Deborah" \f "Name" \i }.

Samuel reached 69 years of age and died in 1801.^[74]

!May said b. Sheffield

!http://www.rockvillemama.com/nmhhistory2.htm (5) Samuel Hitchcock 28 Feb 1731 New Milford d 19 Feb 1801 Sheffield, Berkshire, MA = _____ Samuel Hitchcock served as a private in Capt Peter Ingersol's Company, Col John Brown's Berkshire, MA Regiment. (DAR 37740)

Children of Sarah Sears and Samuel Hitchcock:

- + 61 m I. **Ebenezer⁴ Hitchcock**{ XE "Hitchcock:Ebenezer (1767–1834)" \f "Name" } was born in Marlborough, Middlesex, Massachusetts,{ XE "USA, Massachusetts, Middlesex, Marlborough:(42.3459° N, 71.5523° W):Hitchcock, Ebenezer (1767–1834)" \f "Place" } on 23rd November 1767. He died in Frankfort, Herkimer, New York,{ XE "USA, New York, Herkimer, Frankfort:(43.039° N, 75.0704° W):Hitchcock, Ebenezer (1767–1834)" \f "Place" } on 19th April 1834, at the age of 66.
- + 63 m II. **Reuben Hitchcock**{ XE "Hitchcock:Reuben (1769–1824)" \f "Name" } was born in New Marlborough, Berkshire,{ XE "USA, Massachusetts, Berkshire, New Marlborough:(42.1229° N, 73.2287° W):Hitchcock, Reuben (1769–1824)" \f "Place" } in

⁷⁴ Ancestry.com, U.S., Sons of the American Revolution Membership Applications, 1889-1970 (Provo, UT, USA, Ancestry.com Operations, Inc., 2011), Ancestry.com, Volume: 287.
[Source citation includes one media item]

⁷⁵ Ancestry.com, Connecticut Town Birth Records, pre-1870 (Barbour Collection) (Provo, UT, USA, Ancestry.com Operations Inc, 2006), Ancestry.com.
[Source citation includes one media item]

1769. He died in Vernon, Oneida, New York, { XE "USA, New York, Oneida, Vernon:(43.0795° N, 75.5393° W):Hitchcock, Reuben (1769–1824)" \f "Place" } on 4th April 1824, at the age of 55.

m III. **Silas Hitchcock**{ XE "Hitchcock:Silas (1771–)" \f "Name" \b } was born in New Marlborough{ XE "USA, Massachusetts, Berkshire, New Marlborough:(42.1229° N, 73.2287° W):Hitchcock, Silas (1771–)" \f "Place" } in 1771.

+ 65 f IV. **Jerusha Hitchcock**{ XE "Hitchcock:Jerusha (1773–)" \f "Name" } was born in New Marlborough{ XE "USA, Massachusetts, Berkshire, New Marlborough:(42.1229° N, 73.2287° W):Hitchcock, Jerusha (1773–)" \f "Place" } in 1773.^[74] She died in Ovid, Seneca, New York{ XE "USA, New York, Seneca, Ovid:(42.6765° N, 76.823° W):Hitchcock, Jerusha (1773–)" \f "Place" }.

Family of Hannah Sears and Elisha Sheldon{ TC "Hannah Sears and Elisha Sheldon" \I 3 \f C}

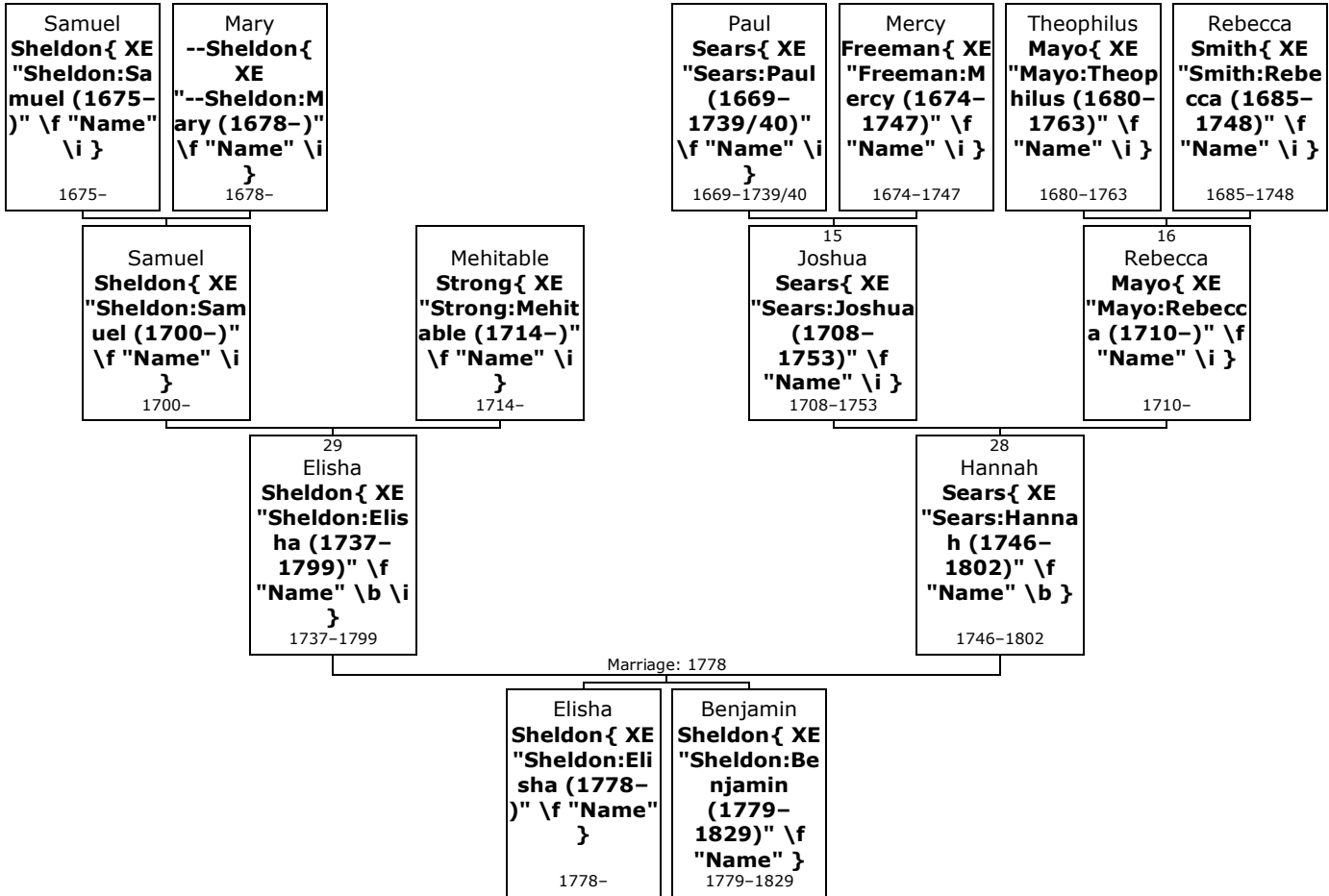

28. **Hannah³ Sears**{ XE "Sears:Hannah (1746–1802)" \f "Name" \b } (*Joshua*²) was born in 1746.^[76, 77] She was the daughter of Joshua Sears{ XE "Sears:Joshua (1708–1753)" \f "Name" \i } (15) and Rebecca Mayo{ XE "Mayo:Rebecca (1710–)" \f "Name" \i } (16).

Hannah was christened in Harwich, Barnstable, Massachusetts, USA,{ XE "USA, Massachusetts, Barnstable, Harwich:(41.6862° N, 70.0758° W):Sears, Hannah (1746–1802)" \f "Place" } on 26th October 1746. She died in New Marlborough, Berkshire,{ XE "USA, Massachusetts, Berkshire, New Marlborough:(42.1229° N, 73.2287° W):Sears, Hannah (1746–1802)" \f "Place" } on 3rd June 1802, at the age of 56.^[76, 77] Hannah was buried in New Marlborough{ XE "USA, Massachusetts, Berkshire, New Marlborough:(42.1229° N, 73.2287° W):Sears, Hannah (1746–1802)" \f "Place" }.^[76]

⁷⁶ Ancestry.com, U.S., Find A Grave Index, 1600s-Current (Provo, UT, USA, Ancestry.com Operations, Inc., 2012), Ancestry.com.

⁷⁷ Ancestry.com, Massachusetts, Town and Vital Records, 1620-1988 (Provo, UT, USA, Ancestry.com Operations, Inc., 2011), Ancestry.com.
[Source citation includes one media item]

not listed in Harwich VR with births of siblings S P May, p 84, No 205, bap., m.

<https://www.wikitree.com/index.php?title=Sears-4166>

- 29.** At the age of 32, Hannah married **Elisha Sheldon**{ XE "Sheldon:Elisha (1737–1799)" \f "Name" \b \i } on Thursday, 12th November 1778, in Framingham, Middlesex,{ XE "USA, Massachusetts, Middlesex, Framingham:(42.2793° N, 71.4162° W):Sears, Hannah (1746–1802)" \f "Place" } when he was 41 years old.^[76, 77] They had two sons: Elisha (1778–) and Benjamin (1779–1829).

Elisha was born in Northampton, Hampshire,{ XE "USA, Massachusetts, Hampshire, Northampton:(42.3251° N, 72.6412° W):Sheldon, Elisha (1737–1799)" \f "Place" } on 17th October 1737.^[76, 77] He was the son of Samuel Sheldon{ XE "Sheldon:Samuel (1700–)" \f "Name" \i } and Mehitable Strong{ XE "Strong:Mehitable (1714–)" \f "Name" \i }.

Elisha reached 61 years of age and died on 24th May 1799.^[76] He was buried in New Marlborough, Berkshire{ XE "USA, Massachusetts, Berkshire, New Marlborough:(42.1229° N, 73.2287° W):Sheldon, Elisha (1737–1799)" \f "Place" }.^[76]

Sons of Hannah Sears and Elisha Sheldon:

- m I. **Elisha⁴ Sheldon**{ XE "Sheldon:Elisha (1778–)" \f "Name" \b } was born in New Marlborough, Berkshire,{ XE "USA, Massachusetts, Berkshire, New Marlborough:(42.1229° N, 73.2287° W):Sheldon, Elisha (1778–)" \f "Place" } on 5th October 1778.^[77]
- m II. **Benjamin Sheldon**{ XE "Sheldon:Benjamin (1779–1829)" \f "Name" \b } was born in Framingham, Middlesex,{ XE "USA, Massachusetts, Middlesex, Framingham:(42.2793° N, 71.4162° W):Sheldon, Benjamin (1779–1829)" \f "Place" } in 1779.^[77] He was known by the title of Hon.

Benjamin died in New Marlborough, Berkshire,{ XE "USA, Massachusetts, Berkshire, New Marlborough:(42.1229° N, 73.2287° W):Sheldon, Benjamin (1779–1829)" \f "Place" } on 2nd December 1829, at the age of 50.^[77]

1st Cousins{ TC "1st Cousins" \I 2 \f C}

Family of Isaac Sears and Grace Daniels{ TC "Isaac Sears and Grace Daniels" \I 3 \f C}

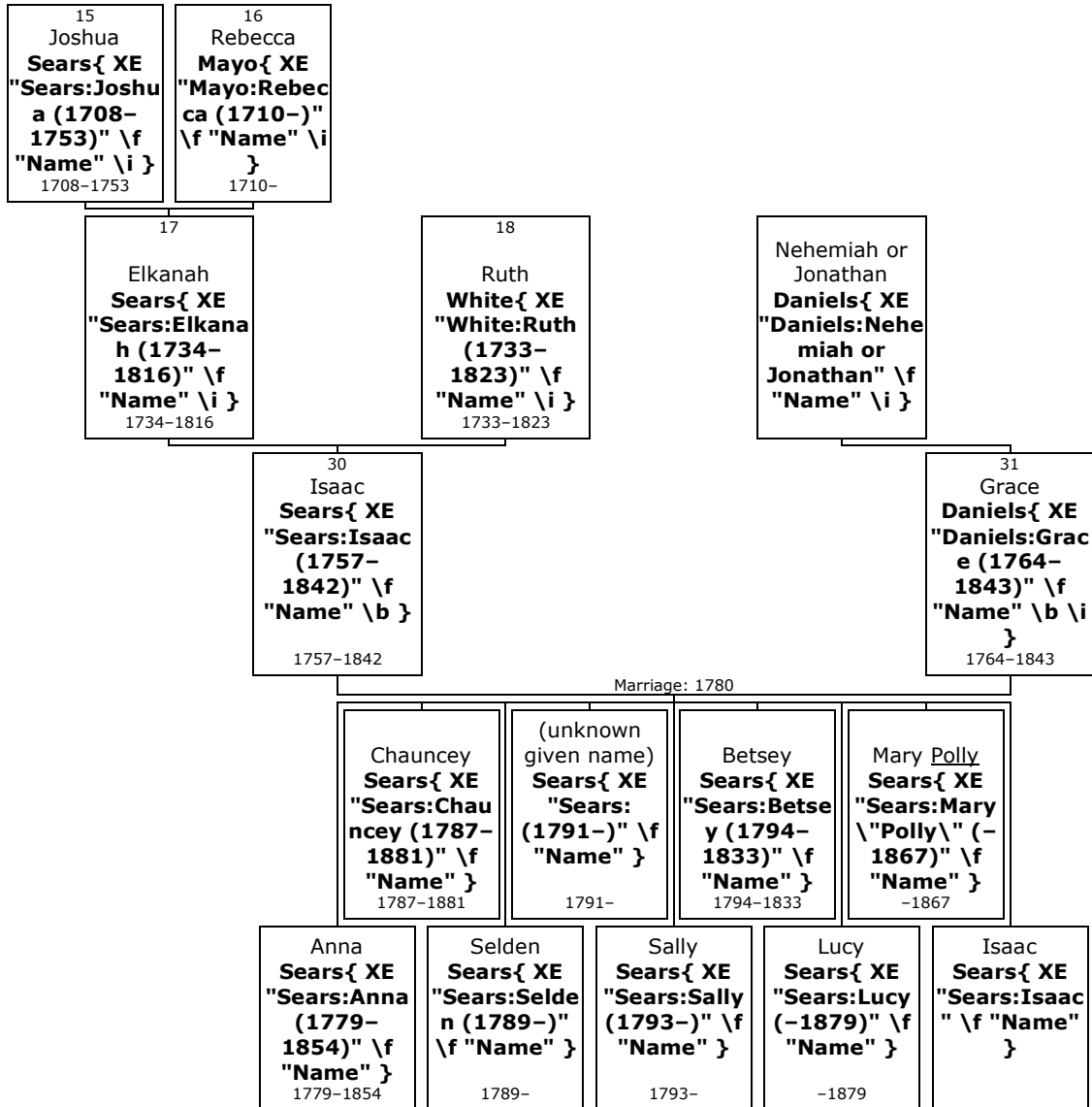

30. **Capt Isaac⁴ Sears**{ XE "Sears:Isaac (1757-1842)" \f "Name" \b } (*Capt Elkanah³, Joshua²*) was born on Thursday, 3rd November 1757, in Chatham, Middlesex, Connecticut, USA{ XE "USA, Connecticut, Middlesex, Chatham: :Sears, Isaac (1757-1842)" \f "Place" }.^[78, 79, 80, 81, 82-83] He was the son of Elkanah

⁷⁸ Ancestry.com, Connecticut Town Birth Records, pre-1870 (Barbour Collection) (Provo, UT, USA, Ancestry.com Operations Inc, 2006), Ancestry.com.
[Source citation includes one media item]

⁷⁹ Ancestry.com, Connecticut, Church Record Abstracts, 1630-1920 (Provo, UT, USA, , 2013), Ancestry.com, Record for Sally Sears. <http://search.ancestry.com/cgi-bin/sse.dll?db=3032&h=487961&indiv=try>.
[Source citation includes one media item]

⁸⁰ Ancestry.com, Connecticut, Church Record Abstracts, 1630-1920 (Provo, UT, USA, , 2013), Ancestry.com, Record for Isaac Sears. <http://search.ancestry.com/cgi-bin/sse.dll?db=3032&h=487914&indiv=try>.
[Source citation includes one media item]

⁸¹ Ancestry.com, Connecticut, Church Record Abstracts, 1630-1920 (Provo, UT, USA, , 2013), Ancestry.com.
[Source citation includes one media item]

⁸² Ancestry.com, U.S. Pensioners, 1818-1872 (Provo, UT, USA, Ancestry.com Operations Inc, 2007), Ancestry.com, The National Archives; Washington, D.C.; Ledgers of Payments, 1818-1872, to U.S. Pensioners Under Acts of 1818 Through 1858 From Records of the Office of the Third Auditor of the Treasury; Record Group Title: Records of the Accounting Officers of the

Sears{ XE "Sears:Elkanah (1734-1816)" \f "Name" \i } (17) and Ruth White{ XE "White:Ruth (1733-1823)" \f "Name" \i } (18).

Isaac died in New Durham{ XE "USA, New York, New Durham: :Sears, Isaac (1757-1842)" \f "Place" } in 1842 at the age of 84.

<https://www.wikitree.com/index.php?title=Sears-2822&action=edit>

!S P May p.224, No 525 Isaac Sears served in the Revolutionary Army. In 1780, he was appointed on Com. at Chatham to provide for the wants of the Continental Army. He removed to New Durham, Greene co, NY, being dism. from the Ch., East Hampton, in 1798. 9 May 1778, he deeded to Isaac Sears 6 acres of land in E Hamp.; 1796, he signed deed to Willard Sears; 1821, Isaac Sears of New Durham, and Benjamin Sears signed deed to Willard Sears.

!

!RESIDENCE: Index, 1790 Fed Census, Middlesex Co CT; 1790; Accelerated Indexing Systems; p 81; OKC Hist Soc; Chatham Town; 1 adult males, 1 male child, 4 females; listed next to father Elkanah and brother, Willard. Ebenezer and David also listed in Chatham Town.

!

!Mayflower Index: No. 29,959 Isaac; spouse Grace; father Elkanah

!

!CT VR

Thank-you for your reply, however, since I posted this message I have learned that my Rebecca Mayo, the daughter of Theophilus Mayo and Rebecca Smith was born 2 Dec 1710 in Harwich, Barnstable, MA and died in Middletown, Middlesex Co., Connecticut. In addition, Grace Daniels and Isaac Sears were married 11/1780 in New London CT by Eleazer Matther (?) although Isaac was living in Chatham at the time. They had ten children eight of whom survived. The marriage was witnessed by Grace's brother Nehemiah. Rev. Pension Abstracts 3:3059

swellington@verizon.net From: SUSAN WELLINGTON [mailto:SUSANWELLINGTON@msn.com] Sent: Tuesday, July 04, 2006 7:23 AM You are welcome--and found the following: Grace Daniels and Isaac Sears were married 11/1780 in New London CT by Eleazer Matther (?) although he was living in Chatham at the time. They had ten children eight of whom survived. The marriage was witnessed by Grace's brother Nehemiah. Rev. Pension Abstracts 3:3059 Susan Wellington, Ph.D.6412 Neil DriveLockport NY 14094716 433-8750 Phone716 433-2773 Fax From: Cathy Kulkin [mailto:waynewave2000@yahoo.com] Sent: Saturday, April 07, 2012 3:21 PMTo: 'Ray Sears' Subject: RE: Sears ancestry Hello again,

!

!There have been discrepancies regarding two different Isaac Sears? in Connecticut, and New York around the same time period. One was a merchant (very well off), completely different from Isaac Sears that was married to Grace Daniels. The reason why I know this merchant was not our Isaac is due to the fact that only the poorest of poor were actually granted a pension for the RW. And Isaac was granted a pension as well as in his death, Grace received it. I have had to research him in depth due to trying to get him on the list for the DAR as a Revolutionary War Soldier. His dates of service in the RW started early January 1776 and ended January 1777. He was a private under Captain Mills company until August of 1776. He was sent to the hospital and then separated from the company. He was also, actually born in Middletown, CT, not Chatham. The family did live in Chatham at the time but his birth is recorded in Middletown, which was only about 7 miles west of Chatham. Elkanah and Ruth may have been out and about at the time of his birth. It is in the pre 1870 Barbour Collection.

I believe there is more, which I will need to get back to you on. Can't remember at the top of my head. Kind Regards, Cat From: Ray Sears [] Sent: Saturday, April 07, 2012 1:37 PM To: waynewave2000@yahoo.com Subject: Sears ancestry Hi Cathy Happy Easter. Maybe there is something in here you didn't have or that has errors. Could you tell me what was incorrect in Isaac's info? Regards Ray

More facts and events for Isaac Sears:

Residence: 17th September 1786 East Hampton, Middlesex, Connecticut{ XE "USA,

Depa.

[Source citation includes one media item]

⁸³ Ancestry.com, Connecticut, Church Record Abstracts, 1630-1920 (Provo, UT, USA, , 2013), Ancestry.com, Record for Betsey Sears. <http://search.ancestry.com/cgi-bin/sse.dll?db=3032&h=487787&indiv=try>. [Source citation includes one media item]

Residence: 1836 - 1848 Connecticut, Middlesex, East Hampton:(41.5759° N, 72.5026° W):Sears, Isaac (1757–1842)" \f "Place" }^[81]
 Albany, New York{ XE "USA, New York, Albany:(42.6029° N, 73.9717° W):Sears, Isaac (1757–1842)" \f "Place" }^[82]

31. Isaac married **Grace Daniels**{ XE "Daniels:Grace (1764–1843)" \f "Name" \b \i } in November 1780 in New London, Connecticut{ XE "USA, Connecticut, New London:(41.4673° N, 72.1043° W):Sears, Isaac (1757–1842)" \f "Place" }.^[79, 80, 82, 83] They had nine children: Anna (1779–1854), Chauncey (1787–1881), Selden (1789–), (unknown given name) (1791–), Sally (1793–), Betsey (1794–1833), Lucy (–1879), Polly (–1867) and Isaac.

Grace was born in 1764. She was the daughter of Nehemiah or Jonathan Daniels{ XE "Daniels:Nehemiah or Jonathan" \f "Name" \i }.

Grace reached 79 years of age and died in New Durham, Greene, New York,{ XE "USA, New York, Greene, New Durham: :Daniels, Grace (1764–1843)" \f "Place" } on 26th February 1843.

Surname from Eunice Lee O'Connor, email, 17 Oct 1999 ! I don't know who posted a 1794 birth date for Grace Daniels Sears, perhaps it was a misreading or a typo. Grace Daniels Sears was born 1764 in Chatham CT, married 11-1780 in New London CT and died 26-2-1843 in New Durham Greene County NY. She received a widow's pension. I downloaded a copy of this document from the NEGHS HeritageQuest site. It can be found Series: M805 Roll: 723 Image: 699 File: W16401 Page: 1 of 10 Surname GivenName State Service SEARS GRACE CT CONT. Her brother Nehemiah Daniels witnessed her marriage and I surmise from census records and Nehemiah Daniels Revolutionary War pension request that their parents were Nehemiah Daniels and perhaps Elizabeth Worthington. NOTE: I do not have proof, only possibility of Grace's and Nehemiah's parentage. Another researcher has indicated that it is possible, but not proven, that Grace's grandparents were Jonathan Daniels and unknown from New London CT. Grace Daniels and Isaac Sears were married 11/1780 in New London CT by Eleazer Matther (?) although Isaac was living in Chatham at the time. They had ten children eight of whom survived. The marriage was witnessed by Grace's brother Nehemiah. Rev. Pension Abstracts 3:3059 swellington@verizon.net Susan Wellington, Ph.D.6412 Neil DriveLockport NY 14094716 433-8750 Phone716 433-2773 Fax

More facts and events for Grace Daniels:

Residence: 1836 - 1848^[82]

Children of Isaac Sears and Grace Daniels:

f I. **Anna⁵ Sears**{ XE "Sears:Anna (1779–1854)" \f "Name" \b } was born in Wilmington, Middlesex, Massachusetts,{ XE "USA, Massachusetts, Middlesex, Wilmington:(42.5465° N, 71.1737° W):Sears, Anna (1779–1854)" \f "Place" } on 21st February 1779.^[84] She was christened in Chatham, Middlesex, Connecticut,{ XE "USA, Connecticut, Middlesex, Chatham: :Sears, Anna (1779–1854)" \f "Place" } on 24th September 1786. Anna died in Westford, Middlesex, Massachusetts,{ XE "USA, Massachusetts, Middlesex, Westford:(42.5793° N, 71.4379° W):Sears, Anna (1779–1854)" \f "Place" } on 29th August 1854, at the age of 75.^[84] She was buried in Westford{ XE "USA, Massachusetts, Middlesex, Westford:(42.5793° N, 71.4379° W):Sears, Anna (1779–1854)" \f "Place" }.^[84]

Anna married **Ezra Carter**{ XE "Carter:Ezra (1774–1855)" \f "Name" \b \i }.^[84] They had two children: Jeremiah (1805–1863) and Sumner (1818–1884).

Ezra was born in Wilmington{ XE "USA, Massachusetts, Middlesex, Wilmington:(42.5465° N, 71.1737° W):Carter, Ezra (1774–1855)" \f "Place" } on Saturday, 14th May 1774.^[84] He reached 81 years of age and died in Westford{ XE "USA, Massachusetts, Middlesex, Westford:(42.5793° N, 71.4379° W):Carter, Ezra (1774–1855)" \f "Place" } on 22nd June 1855.^[84] Ezra was buried in Westford{ XE "USA, Massachusetts, Middlesex, Westford:(42.5793° N, 71.4379° W):Carter, Ezra (1774–1855)" \f "Place" }.^[84]

m II. **Chauncey Sears**{ XE "Sears:Chauncey (1787–1881)" \f "Name" \b } was born in Chatham, Middlesex, Connecticut,{ XE "USA, Connecticut, Middlesex, Chatham: :Sears,

⁸⁴ Ancestry.com, U.S., Find A Grave Index, 1600s–Current (Provo, UT, USA, Ancestry.com Operations, Inc., 2012), Ancestry.com, Record for Anna Carter. <http://search.ancestry.com/cgi-bin/sse.dll?db=60525&h=85754545&indiv=try>.

Chauncey (1787–1881)" \f "Place" } in 1787.^[85, 86] He died in Cascade, Kent, Michigan,{ XE "USA, Michigan, Kent, Cascade:(42.9122° N, 85.4981° W):Sears, Chauncey (1787–1881)" \f "Place" } on 28th February 1881, at the age of 94.^[85]

Chauncey Sears married **Sally Shufeldt**{ XE "Shufeldt:Sally (1797–)" \f "Name" \b \i } in New Durham, New York{ XE "USA, New York, New Durham: :Sears, Chauncey (1787–1881)" \f "Place" }. They had five children: Horace (1819–1912), Austin (1822–1894), Grosvenor (1824–1894), Adeline (1826–1896) and Lansing (1828–).

Sally was born in New Durham{ XE "USA, New York, New Durham: :Shufeldt, Sally (1797–)" \f "Place" } in 1797.

- m III. **Selden Sears**{ XE "Sears:Selden (1789–)" \f "Name" \b } was born in 1789.
- f IV. **(unknown given name) Sears**{ XE "Sears: (1791–)" \f "Name" \b } was born in 1791.
- f V. **Sally Sears**{ XE "Sears:Sally (1793–)" \f "Name" \b } was born in New York{ XE "USA, New York:(42.7531° N, 74.2224° W):Sears, Sally (1793–)" \f "Place" } in 1793.^[79] She was baptised on 6th June 1790.^[79]
- Sally Sears married **Urban Shepard**{ XE "Shepard:Urban" \f "Name" \b \i }. They had one son: Alanson (1821–).
- !SPOUSE-CHILD: Email from Joyce Lindblom; 1821; dtd Jan 1996; ;
- f VI. **Betsey Sears**{ XE "Sears:Betsey (1794–1833)" \f "Name" \b } was born in East Hampton, Middlesex, Connecticut,{ XE "USA, Connecticut, Middlesex, East Hampton:(41.5759° N, 72.5026° W):Sears, Betsey (1794–1833)" \f "Place" } in 1794.^[83, 87] She was baptised on 9th March 1794.^[83] Betsey died in Durham, Greene, New York,{ XE "USA, New York, Greene, Durham:(42.3994° N, 74.1728° W):Sears, Betsey (1794–1833)" \f "Place" } on 28th January 1833, at the age of 39.^[87] She was buried in East Durham{ XE "USA, New York, Greene, East Durham:(42.3725° N, 74.0961° W):Sears, Betsey (1794–1833)" \f "Place" }.^[87]
- Betsey married **Vincent Stilwell**{ XE "Stilwell:Vincent (1790–1880)" \f "Name" \b \i }.^[87] They had no known children.
- Vincent was born in 1790.^[87] He reached 90 years of age and died on 14th August 1880.^[87] Vincent was buried in Stone Bridge Cemetery, Durham{ XE "USA, New York, Greene, Durham, Stone Bridge Cemetery: :Stilwell, Vincent (1790–1880)" \f "Place" }.^[87]
- f VII. **Lucy Sears**{ XE "Sears:Lucy (–1879)" \f "Name" \b }. Lucy was christened in Chatham{ XE "USA, Connecticut, Middlesex, Chatham: :Sears, Lucy (–1879)" \f "Place" } on 24th September 1786. She died in Durham, Greene, New York,{ XE "USA, New York, Greene, Durham:(42.3994° N, 74.1728° W):Sears, Lucy (–1879)" \f "Place" } on 6th March 1879. Lucy was buried in Stone Bridge Cemetery, Durham{ XE "USA, New York, Greene, Durham, Stone Bridge Cemetery: :Sears, Lucy (–1879)" \f "Place" }.
Lucy Sears married **Christopher Watrous**{ XE "Watrous:Christopher (1782–1831)" \f "Name" \b \i } on Monday, 24th September 1804, in East Hampton, Middlesex, Connecticut{ XE "USA, Connecticut, Middlesex, East Hampton:(41.5759° N, 72.5026° W):Sears, Lucy (–1879)" \f "Place" }. They had five children: Phineas (1805–1888), Betsey (1814–1897), William (1822–1881), Sears and Harriet.
Christopher was born in Lyme, New London,{ XE "USA, Connecticut, New London, Lyme:(41.3976° N, 72.3468° W):Watrous, Christopher (1782–1831)" \f "Place" } on Tuesday, 17th December 1782. He was the son of Gershom Watrous{ XE "Watrous:Gershom" \f "Name" \i } and Mehetable --Watrous{ XE "--Watrous:Mehetable" \f "Name" \i }.
Christopher reached 48 years of age and died in Durham, Greene, New York,{ XE "USA, New York, Greene, Durham:(42.3994° N, 74.1728° W):Watrous, Christopher (1782–

⁸⁵ Ancestry.com, U.S., Find A Grave Index, 1600s-Current (Provo, UT, USA, Ancestry.com Operations, Inc., 2012), Ancestry.com.

⁸⁶ Ancestry.com, Michigan, Death Records, 1867-1950 (Provo, UT, USA, Ancestry.com Operations, Inc., 2015), Ancestry.com.

⁸⁷ Ancestry.com, U.S., Find A Grave Index, 1600s-Current (Provo, UT, USA, Ancestry.com Operations, Inc., 2012), Ancestry.com, Record for Betsey Stilwell. <http://search.ancestry.com/cgi-bin/sse.dll?db=60525&h=29018051&indiv=try>.

1831)" \f "Place" } on 3rd March 1831. He was buried in Stone Bridge Cemetery, Durham{ XE "USA, New York, Greene, Durham, Stone Bridge Cemetery: :Watrous, Christopher (1782-1831)" \f "Place" }.

http://www.rootsweb.com/~nygreen2/christopher_watrous_-_ledger_book.htm The Barbour Collection shows: - Watrous, Christopher, son of Gershom and Mehetable b. Dec 17, 1782 Lyme Vital Records Vol. 1 Pg 162 Christopher Watrous married Lucy Sears, daughter of Isaac Sears; 24 Sept 1804 in East Hampton, CT. Christopher and Lucy had five children: Phineas, Sears, Betsey Caroline, Harriet and William. The family legend/story about Christopher and Lucy drowning in the Hudson River is not accurate, herein are the more accurate details: Source- Beers, History of Greene County, 1886, J.B. Beers Publishing Company FHL US Film #0908908. The Katskill Creek.... "The Katskill Creek is a very rapid stream in time of high water, and much difficulty has been experienced in maintaining bridges across it. Probably the first bridge across the stream was built by Jacob Carter. It has been rebuilt several times and in 1878, a substantial iron bridge was constructed, which, like its predecessors is called the Carter Bridge. He also built a bridge across the Katskill at Brown's mill, and soon after its completion, he was seen approaching it from the north side of the stream; but as he did not appear on the south side, search was made for him which resulted in finding his body in the water below. Whether it was a case of accidental drowning will never be known. March 3d, 1831, the stream was very high and full of floating ice. The bridge at Oak Hill was very much weakened by the undermining of the abutments. Vincent Stillwell attempted to cross it with horses and sleigh, having with him his brother-in-law, Christopher Waterous, and Waterous' sister. They were thrown into the stream, and Mr. Waterous and his sister were drowned. It was two weeks or more before Mr. Waterous' body was found. " - Christopher's Watrous? wife did not die in the Hudson River as the family story goes. Lucy Sears was Christopher Watrous' widowed wife after his demise. Who the sister was in this tragedy is not known at this time. While looking for evidence about Christopher Watrous' death, two indentures of Christopher Watrous' property were found. In the Index of Deeds, Greene County, New York two quit claim deeds were granted by Sears Watrous to sisters Betsey Caroline Watrous Wetmore and Harriet Watrous Snyder. They were recorded December 26, 1832 and December 27, 1832. In these deeds reference is made to the deceased Christopher Watrous, and that Betsey Caroline and Harriet are rightful heirs at law to his property. Betsey Caroline was married to Hiram F. Wetmore and Harriet was married to John Snyder. FHL US film #479682. There were earlier indentures in the land records of Greene County which shows land transactions (quit claim deed) between Isaac Sears Sr. and wife Grace, and Christopher Watrous and another granting of land to Christopher Watrous and Isaac Sears Jr. and wife Polly. This is recorded Nov. 28, 1827, FHL US film # 479666 and vols. K & L #479679 The Greene County Historical Society, Vedder Research Library returned a search for Christopher Watrous. Their records showed that in the Stone Bridge Cemetery, Town of Durham there is a tombstone transcription entry. It shows an entry reading: "Fairbrother Watrous", d. March 3 1831, age 48. This is Christopher's burial site. Also the 1813 tax assessment roll of Greene County placed Christopher Watrous in the town of Durham, owning 14 acres and one house valued at \$200.00. The Greene County Supervisors Reports for 1819 include a list of constables with Christopher serving as a constable in Durham. Both the 1820 and 1830 censuses carry the enumeration of his Durham household. In 1820 Christopher Watson (a note questions the spelling of his surname) was living next to Isaac Sears, Jr. while Isaac Sears (Sr) and Chauncy Sears were living nearby. Christopher's household at that time consisted of 1 male under 10, 2 males between 10 and 15, 1 male between 26 and 44, 1 female under 10, 2 females between 10 and 15, and 1 female between 16 and 44. This would indicate that Christopher had 6 children or another female not identified as of yet. Lucy Sear's sister, whose name was Betsey, was married to Vincent Stilwell. Betsey died January 28, 1833, age 39- only 2 years after Christopher Watrous' death. Vincent was left a widower. Vincent Stilwell then married Lucy - Christopher's widow. We find them living in Durham, NY in the 1855 census. There are two entries in the church membership of the First Presbyterian Church of Durham. One pertains to church membership and another notation of itself. Noted as: "...1831 Sept 4 widow Lucy Watrous ...dismissed (she joined the church on that date and was dismissed later since the list refers to members admitted by Rev. Seth Williston, as pastor). A note on the line beneath her name reads "married to V. Stilwill" and beneath that: "Betsey, wife of Vincent Stilwell died." No dates are provided for Lucy's dismissal or remarriage. p.188 pp. 237-238 Sept. 1, Vincent Stillwell died 14 Aug 1880, age 90 years Lucy Stillwell died

6 March 1879, 86 years Vincent and Betsey are both buried in the Stone Bridge Cemetery, in Durham, NY. 1810 Census Greene County Town Durham Christopher Waters <http://www.hopefarm.com/1810cens.htm#Durham> The Greene County Historical Society, Vedder Research Library returned a search for Christopher Watrous. Their records showed that in the Stone Bridge Cemetery, Town of Durham there is a tombstone transcription entry. It shows an entry reading: "Fairbrother Watrous", d. March 3 1831, age 48. This is Christopher's burial site. Also the 1813 tax assessment roll of Greene County placed Christopher Watrous in the town of Durham, owning 14 acres and one house valued at \$200.00. The Greene County Supervisors Reports for 1819 include a list of constables with Christopher serving as a constable in Durham. Both the 1820 and 1830 censuses carry the enumeration of his Durham household. In 1820 Christopher Watson (a note questions the spelling of his surname) was living next to Isaac Sears, Jr. while Isaac Sears (Sr) and Chauncy Sears were living nearby. Christopher's household at that time consisted of 1 male under 10, 2 males between 10 and 15, 1 male between 26 and 44, 1 female under 10, 2 females between 10 and 15, and 1 female between 16 and 44. This would indicate that Christopher had 6 children or another female not identified as of yet. 1810 CENSUS Transcribed from "Old Times Corner" first series published in 1932 by the Greene County Historical Society edited by George Halcott Chadwick ("C") and Mrs. Jessie Van Vechten Vedder ("V") originally appearing as a column in the Catskill Examiner Christopher Waters CHRISTOPHER WATROUS The Barbour Collection shows: - Watrous, Christopher, son of Gershom and Mehetable b. Dec 17, 1782 Lyme Vital Records Vol. 1 Pg 162 Christopher Watrous married Lucy Sears, daughter of Isaac Sears; 24 Sept 1804 in East Hampton, CT. Christopher and Lucy had five children: Phineas, Sears, Betsey Caroline, Harriet and William. The family legend/story about Christopher and Lucy drowning in the Hudson River is not accurate, herein are the more accurate details: Source-Beers, History of Greene County, 1886, J.B. Beers Publishing Company FHLUS Film #0908908. From: "Chris Burningham" <cburni@xmission.com> <mailto:cburni@xmission.com> > To: <NYGREENE-L@rootsweb.com> <mailto:NYGREENE-L@rootsweb.com> > Sent: Wednesday, September 05, 2001 4:34 PMSubject: RE: [GREENE COUNTY] "Ye Olden Time" HI, I am grateful for your offer to look in the book "Ye olden Time" I have been researching the Watrous and Sears families from the Coxsackie area. The Watrous family is also found as Waterous or Waters. Looking especially for Phineas, or William or Hiram or Christopher Watrous. This family migrated from Conn pre-1800 and then settled in Greene NY. Could you check and see if there are any names familiar. Thankyou, Chris cburni@xmission.com

Lucy Sears married **Vincent Stilwell**{ XE "Stilwell:Vincent (1790-1880)" \f "Name" \b \i }.^[87] They had no known children.

Vincent was born in 1790.^[87] He reached 90 years of age and died on 14th August 1880.^[87]

- f VIII. **Mary Polly Sears**{ XE "Sears:Mary \"Polly\" (-1867)" \f "Name" \b }. Polly was christened in Chatham{ XE "USA, Connecticut, Middlesex, Chatham: :Sears, Mary \"Polly\" (-1867)" \f "Place" } on 3rd February 1788. She died in Granby, Oswego, New York,{ XE "USA, New York, Oswego, Granby:(43.2923° N, 76.44° W):Sears, Mary \"Polly\" (-1867)" \f "Place" } on 2nd February 1867.

Mary Polly Sears married **Johannes Shufelt**{ XE "Shufelt:Johannes (1787-<1850)" \f "Name" \b \i }. They had six children: William (1814-1864), Nancy (1816-), Sheldon (1818-1852), Sally (1819-), Mary (1824-) and Adelia (1828-1904).

Johannes was born in Dutchess{ XE "USA, New York, Dutchess:(41.7645° N, 73.7472° W):Shufelt, Johannes (1787-<1850)" \f "Place" } on Sunday, 2nd December 1787. He was the son of William Shufelt{ XE "Shufelt:William" \f "Name" \i } and Maritje Newkirk{ XE "Newkirk:Maritje" \f "Name" \i }.

Johannes died before 1850.

<https://www.ancestry.com/family-tree/person/tree/115568257/person/230148501512/facts> accessed 31 Dec 2019 tree of Charles_Willford

- m IX. **Isaac Sears**{ XE "Sears:Isaac" \f "Name" \b }.^[80] Isaac was baptised on 24th September 1786.^[80] He was christened in Chatham{ XE "USA, Connecticut, Middlesex, Chatham: :Sears, Isaac" \f "Place" } on 24th September 1786.

Willard Sears{ TC "Willard Sears" \I 3 \f C}

32. Willard⁴ Sears{ XE "Sears:Willard (1760–1838)" \f "Name" \b } (*Capt Elkanah³, Joshua²*) was born on Monday, 8th September 1760, in Chatham, Middlesex, Connecticut, USA{ XE "USA, Connecticut, Middlesex, Chatham: :Sears, Willard (1760–1838)" \f "Place" }.^[88, 89, 90, 91–92] He was the son of Elkanah Sears{ XE "Sears:Elkanah (1734–1816)" \f "Name" \i } (17) and Ruth White{ XE "White:Ruth (1733–1823)" \f "Name" \i } (18).

Willard died in East Hampton{ XE "USA, Connecticut, Middlesex, East Hampton:(41.5759° N, 72.5026° W):Sears, Willard (1760–1838)" \f "Place" } on 23rd August 1838, at the age of 77.^[88–91] He was buried in Lakeside Cemetery, East Hampton{ XE "USA, Connecticut, Middlesex, East Hampton, Lakeside Cemetery: :Sears, Willard (1760–1838)" \f "Place" }.^[89]

<https://www.wikitree.com/wiki/Sears-1759>

!S P May No 526 p.225 Willard Sears was a reliable, Christian man, and unusually conscientious. It is related of him that on one occasion having found a pocketbook with money in it, and no owner appearing, he mounted his horse and rode continuously for three days, until he placed it in the hands of its owner.

!

!RESIDENCE: Index, 1790 Fed Census, Middlesex Co CT; 1790; Accelerated Indexing Systems; p 81; OKC Hist Soc; Chatham Town; 1 adult males, 2 females; listed next to father Elkanah and brother, Isaac. Ebenezer and David also listed in Chatham Town. !Mayflower Index: No. 30,044; Willard Sears; spouse Betsey (Clark) Strong; father Elkanah

!

!DAR # 54141 enlisted, 1777 as private in Captain Blackman's company, Col Roger's CT regiment of State troops. He was placed on the pension roll, 1832, of East Haddam, CT, where he was born and died

!

!http://freepages.genealogy.rootsweb.com/~jdevlin/town_hist/chatham_1884_hist.htm The History of Middlesex County 1635-1885J. H. Beers & Co., 36 Vesey Street, New York 1884 Pages 174-217 TOWN OF CHATHAM. BY Rev. M. L. ROBERTS [transcribed by Janece Streig] GEOGRAPHICAL AND DESCRIPTIVE.

The town of Chatham is situated in the northeast corner of the county, and is bounded on the north by Glastonbury, in Hartford county, on the east by Marlborough, in Hartford county, and Colchester, in New London county, on the south by East Haddam and Haddam, and on the west by Middletown and Portland. It is separated from Middletown by the Connecticut River, which washes the southwest corner of the town. The township was originally a part of Middletown, the original grant of which extended three miles in breadth east of the river, and in 1673, by virtue of another grant, it was extended three miles in breadth further east. This tract was incorporated, at the October session of the General Assembly, in 1867, as a town, and named Chatham, after a town of the same name in England, noted for its ship building, a branch of industry in which it was expected it would some day rival its English namesake. At the time of its incorporation it embraced the whole of the ecclesiastical parish of East Middletown, a part of the parish of Middle Haddam, the whole of the parish of East Hampton, and a small portion of the parish of Pine Swamp, alias Westchester. The name of East Middletown Parish was changed to Chatham, and in 1842 it was set off as a separate town by the name of Conway, but at the same session the name was changed to Portland. The township is about nine miles in length from north to south, about six miles in width on its southern border, and three on its northern. Its surface is very uneven and hilly, and in some parts mountainous. The soil is hard and rocky, and better adapted to grazing than to cultivation. The Bolton Mountains, or rather a continuation of that range, are situated on the western border of the town. Meshomasic or, in colloquial parlance, Somersic Mountain, one of this range, situated partly in Chatham and part in Glastonbury, is famous for its rattlesnakes with which it has abounded from its discovery to the present day. So numerous were these reptiles at the time of the first settlement that the towns were under the necessity of offering a

⁸⁸ Ancestry.com, U.S., Sons of the American Revolution Membership Applications, 1889-1970 (Provo, UT, USA, Ancestry.com Operations, Inc., 2011), Ancestry.com, Volume: 96.
[Source citation includes one media item]

⁸⁹ Ancestry.com, U.S., Find A Grave Index, 1600s-Current (Provo, UT, USA, Ancestry.com Operations, Inc., 2012), Ancestry.com.

⁹⁰ Ancestry.com, U.S., Sons of the American Revolution Membership Applications, 1889-1970 (Provo, UT, USA, Ancestry.com Operations, Inc., 2011), Ancestry.com, Volume: 62.
[Source citation includes one media item]

⁹¹ Ancestry.com, Connecticut, Church Record Abstracts, 1630-1920 (Provo, UT, USA, , 2013), Ancestry.com.
[Source citation includes one media item]

⁹² Ancestry.com, Early Connecticut Marriages (Provo, UT, USA, Ancestry.com Operations, Inc., 2012), Ancestry.com.
[Source citation includes one media item]

bounty for their destruction, which was usually "six-pence a tail," to copy the quaint language of the record. The late Dr. CHAPIN, in his "Glastonbury for two hundred years," published in 1853, says that the Indian name of this mountain testifies to the same peculiarity, Me-shom-as sek signifying great rattlesnake. This definition he obtained from "Roger WILLIAMS' Key to the Indian Language," Meshom, great, and sesek or assek, rattlesnake, or an abundance of rattlesnakes. The Hon. J. Hammond TRUMBULL, of Hartford, who is considered the best authority on the Indian language in the United States, in a volume published in 1881, entitled, "Indian names of places in and on the borders of Connecticut, with interpretations of some of them," says that there is no foundation for Dr. CHAPIN's interpretation, but that he can suggest nothing better unless it can, by some steep declivity or deep chasm, be identified with Massawomasog, which denotes a great declivity (literally, down going), and is applicable to a steep ledge, hillside, or high bank, which might easily be found in the vicinity. Of later years these reptiles are not found in any considerable numbers, but occasionally, in a hot, dry season, some have been killed even in the center of near villages. Bald Hill, famous for its rattlesnakes, trailing arbutus, and peculiar kind of quartzite rock much sought after for scythe stones, is situated in the same locality. Great Hill, or Governor's Ring, so called from the supposition that Governor WINTHROP obtained gold enough to make a ring from its rocks, is the southwestern terminus of this range. The famous Cobalt Mines, of which more will be said in another place, were excavated in the side of this mountain. A good view of Long Island Sound can be obtained from its summit on a clear day, and with the aid of a powerful glass, vessels can be seen sailing up and down upon its waters, some thirty miles away. CLARK's Hill, so called from its having been in the possession of families of that name from the first settlement of East Hampton Parish to the present day, lies to the eastward of Great Hill. A good view of the sound can also be had from this point. Pocotopaug Lake, northeast of the village of East Hampton and near to Marlborough line, is a beautiful sheet of water, nearly nine miles in circumference, following the circuitous windings of its shore. Its Indian name was always supposed by the inhabitants of the town to mean "clear water," as its waters are very clear and transparent; but Mr. TRUMBULL, in the work before mentioned, says that the meaning of the name is obscure, but the interpretation which seems most probable is "divided pond," Pohqutaepaug, the pond having the appearance of being double, composed of two nearly circular ponds, united by a short narrow strait. This pond was in the line of the old bridle path between providence and Middletown, and travelers were taken across this strait on a raft. This bridle path entered the town just north of the present dwelling house of Morris COLBERT, and passing down the hill in a westerly direction ascended the Bear Swamp ledges through what is now known as the Dugway, and, swinging to the northward of Great or BAKER's Hill, so-called, it came out on the shore of the lake, on MARKHAM's Point, where it crossed to what is now called HINKLEY's Point, then turning to the left and northward of the lake crossed the summit of CLARK's Hill, and thence in a westerly direction toward Middletown. The waters of this lake abounded with pickerel, perch, bullheads, roach, and dace for a number of years after the settlement of the town, but the introduction of black bass, a game fish, into its waters a few years since, has had a tendency to diminish the original denizens, both its size and number. There are no inlets, of any size, to Pocotopaug Lake, it being fed probably by low springs, as rains that do not run off the ground do not affect its height materially. There is a beautiful legend connected with this lake, that an Indian maiden sacrificed herself here by direction of the Great Spirit, and the promise to her was that no person should ever be drowned in its bosom. Taking the legend for what it is worth, it is a well established fact that up to the time of writing, no person, so far as known, has ever been drowned there. To the east of this lake rises a bare round hill, known as BAKER's Hill, from a family of that name that live near its summit. On the top of this hill a well was dug some 40 feet in depth for some parties in New York, who were intending to build a summer house here, but for some reason failed to do so. This well is now nearly filled with stones and debris dropped in by visitors to this locality. A good view of Colchester, Westchester, Marlborough, Gilead, and East Haddam can be obtained from this point. A chain of ledges skirts along the eastern side of this hill and runs in a northerly direction into the town of Marlborough. At the foot of these ledges lies Bear Swamp, a locality where bears were plenty at the time of the first settlement of the town, and which is almost impenetrable on account of the thick growth of underbrush that covers its face. Bear Swamp Brook, a continuation of what is known further south as Potash Brook, runs through this swamp in a northerly direction into Marlborough where it loses itself in DICKINSON's Stream. Flat Brook, near the eastern border of the town, flows southerly under the Rapallo Viaduct on the Air Line Railroad, and empties into Salmon River near the Colchester line. Salmon River, the two principal sources of which rise in Hebron and Lebanon, flows through the parish of Westchester and across the southwestern corner of the town, separating the parish of East Hampton from Westchester, and the town of East Haddam from Haddam, and empties into the Connecticut near Mount Tom. On either side of this stream rise abrupt hills covered with groves of hemlock, oak, and chestnut. In Connecticut Land Records, Volume 111, page 85, this river is described as the west bound of Jeremy ADAMS' farm in Colchester, in a grant to him from Uncas, in 1662, and is called the Tatamucuntaway. Pine Brook, the only outlet of Pocotopaug Lake, is recorded in Connecticut Land Records, volume I, page 456, as Niuppaquashneag Brook. This word, evidently corrupted, property represents Wunni-approquasinne-auke and means good flag place or where flags (Approquash, for making mats, etc.) are plenty (TRUMBULL's

Indian Names, page 1). This stream flows in a southwesterly direction, furnishing power for the many thriving industries of East Hampton, and empties into Salmon River a few miles from its mouth. Muddy Gutter Brook and Green River flow through the central part of the town in a southerly direction, and empty into Pine Brook. Cobalt Brook, rising near the Cobalt Mine, flows through the village of Middle Haddam and empties into the Connecticut River near the old ship-yard. TAYLOR's Creek, flowing down from Great Hill Meadow, in the east part of Portland, divides the two towns. Glen Falls, where the water flows over a precipice 30 feet in height, is on this stream. Eastward from the Connecticut River, the ground rises, in some places gradually, and in others precipitously for about a mile, the height bearing the name of Hog Hill from the following circumstance. Soon after the settlement of this locality the hogs belonging to the early settlers were suffered to roam at large, under certain restraints. During a severe storm they took refuge in the basement of the first meeting house in Middle Haddam Parish, which stood near the southern extremity of this hill. This house, standing on a side hill, was stoned up underneath, leaving a vacant place under the church, a small aperture being left in the wall for ingress and egress. Some party or parties closed this aperture and imprisoned these animals, who were not discovered until the following Sabbath, when their grunting disclosed their presence, and they were released from their prison. East of this hill, and about a mile distant from summit to summit, rises another to about the same height, known as Chestnut Hill. Through the valley, between these two hills, Green River flows, uninterrupted to its mouth. South of East Hampton village is MILLER's Hill, so called from an early settler of that name, and to the south and east of this are the ranges known as the SMITH Hills. Mill Brook rises between these two hills, and flows southerly to Salmon River. BEVIN Hill, in the western part of East Hampton village, and MOTT Hill, north of the lake, were so called from early settlers of those names. North of Pocotopaug Lake is a stream known as WELLS' Brook, which flows in a southerly direction, and empties into DICKINSON Stream in Marlborough. All the streams described abounded with delicious brook trout at the time of the early settlement, but in many of them they have long since disappeared, and their number greatly diminished in the others.

!

!NEHGS Cemetery records ae 78

Marriages with Rhoda Bailey and Betsy Clark (Page 69) are known.

Family of Willard Sears and Rhoda Bailey{ TC "Willard Sears and Rhoda Bailey" \I 4 \f C}

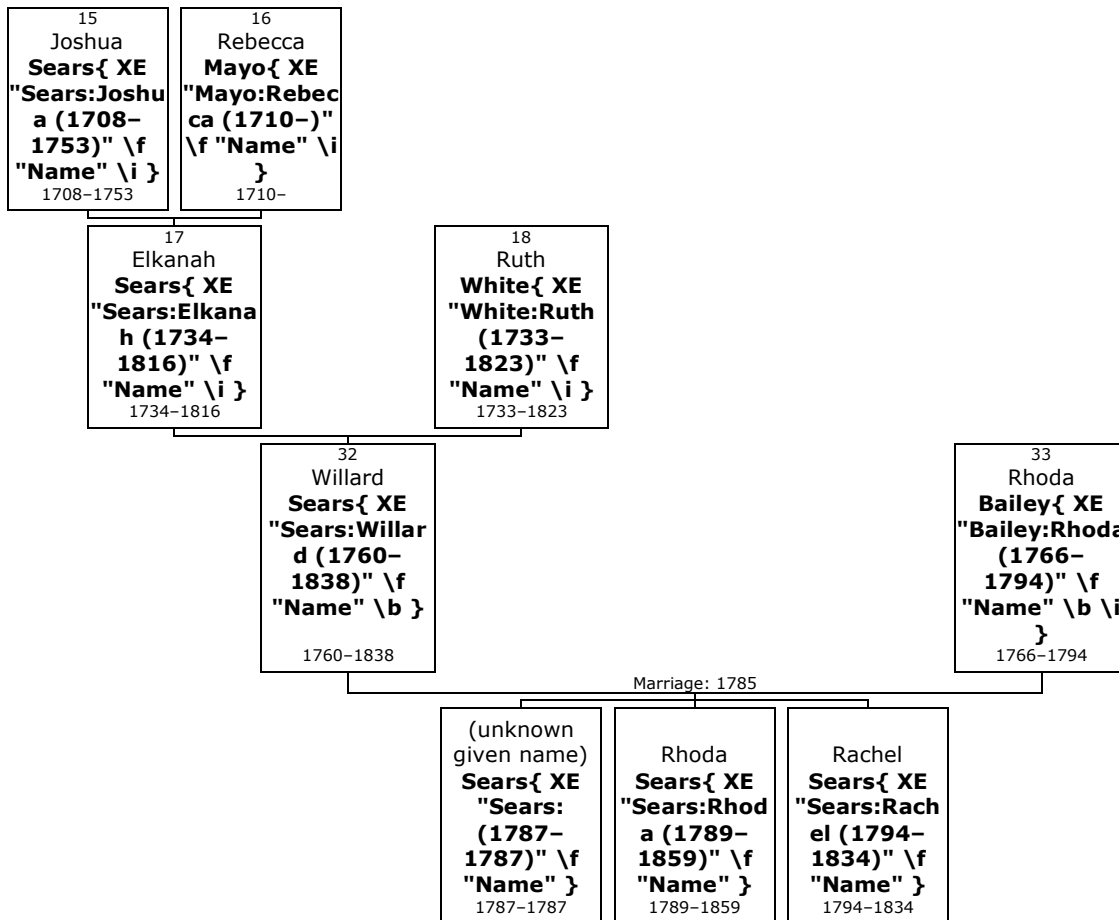

Here are the details about **Willard Sears**{ XE "Sears:Willard (1760–1838)" \f "Name" \b } first marriage, with Rhoda Bailey. You can read more about Willard on page 65.

33. Willard Sears married **Rhoda Bailey**{ XE "Bailey:Rhoda (1766–1794)" \f "Name" \b \i } on Wednesday, 23rd November 1785. They had three children: (unknown given name) (1787–1787), Rhoda (1789–1859) and Rachel (1794–1834).

Rhoda was born in perh, East Hampton,{ XE "USA, Connecticut, Middlesex, East Hampton, perh: :Bailey, Rhoda (1766–1794)" \f "Place" } in March 1766. She reached 27 years of age and died on 17th February 1794.

Children of Willard Sears and Rhoda Bailey:

- I. **(unknown given name)⁵ Sears**{ XE "Sears: (1787–1787)" \f "Name" \b } was born in East Hampton{ XE "USA, Connecticut, Middlesex, East Hampton:(41.5759° N, 72.5026° W):Sears, (1787–1787)" \f "Place" } on 2nd April 1787. He or she died in East Hampton{ XE "USA, Connecticut, Middlesex, East Hampton:(41.5759° N, 72.5026° W):Sears, (1787–1787)" \f "Place" } on 2nd April 1787.
- f II. **Rhoda Sears**{ XE "Sears:Rhoda (1789–1859)" \f "Name" \b } was born in East Hampton{ XE "USA, Connecticut, Middlesex, East Hampton:(41.5759° N, 72.5026° W):Sears, Rhoda (1789–1859)" \f "Place" } on 29th March 1789. She died in 1859 at the age of 69.
- f III. **Rachel Sears**{ XE "Sears:Rachel (1794–1834)" \f "Name" \b } was born in East Hampton{ XE "USA, Connecticut, Middlesex, East Hampton:(41.5759° N, 72.5026° W):Sears, Rachel (1794–1834)" \f "Place" } on 11th February 1794. She died on 22nd January 1834, at the age of 39.

Family of Willard Sears and Betsy Clark{ TC "Willard Sears and Betsy Clark" \i 4 \f C}

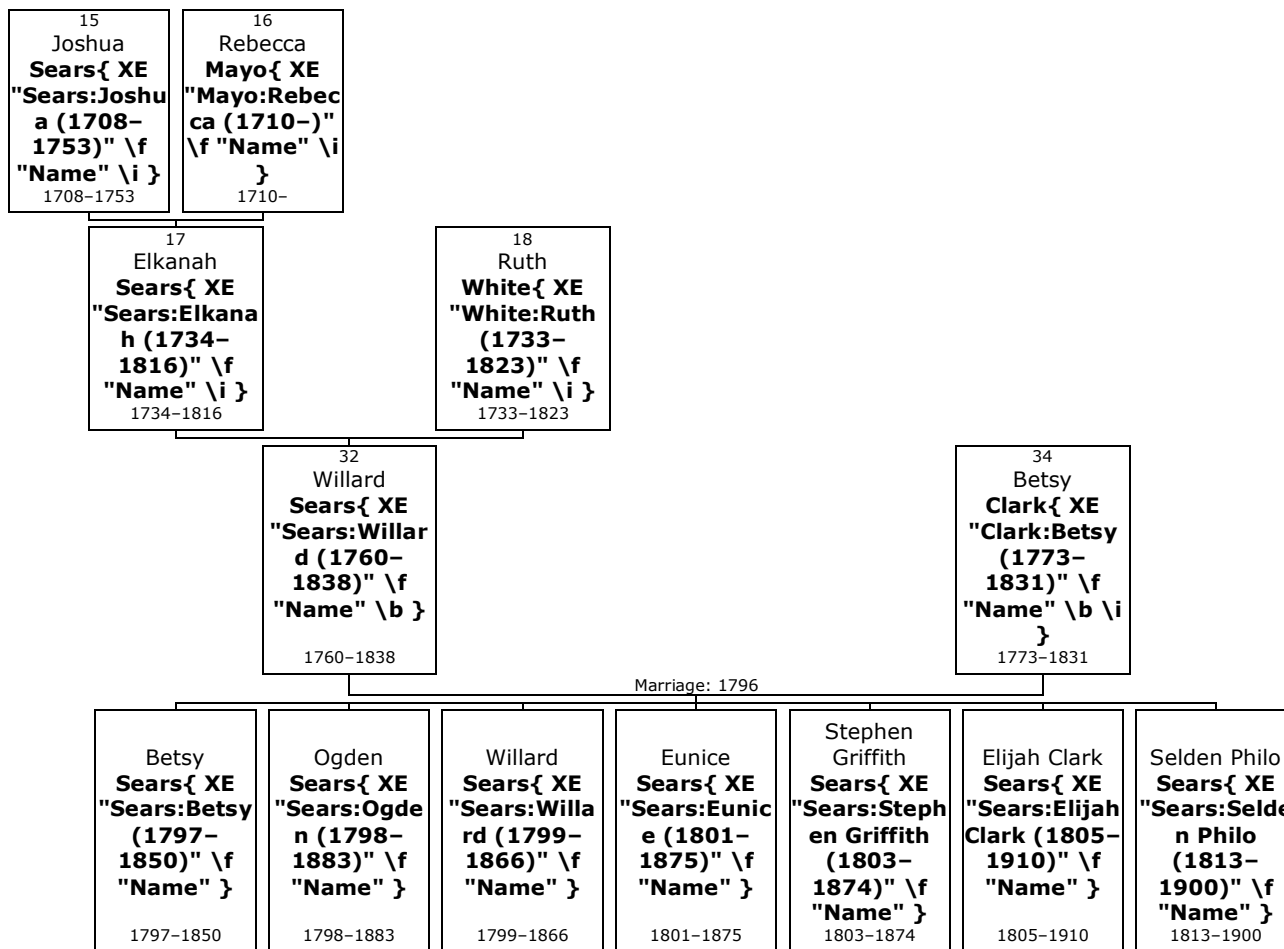

Here are the details about **Willard Sears**{ XE "Sears:Willard (1760–1838)" \f "Name" \b } second marriage, with Betsy Clark. You can read more about Willard on page 65.

- 34.** Willard Sears married **Betsy Clark**{ XE "Clark:Betsy (1773–1831)" \f "Name" \b \i } on Sunday, 22nd May 1796, in Chatham{ XE "USA, Connecticut, Middlesex, Chatham: :Sears, Willard (1760–1838)" \f "Place" }.^[88–90, 92] They had seven children: Betsy (1797–1850), Ogden (1798–1883), Willard (1799–1866), Eunice (1801–1875), Stephen (1803–1874), Elijah (1805–1910) and Selden (1813–1900).

Betsy was born in perh, East Hampton,{ XE "USA, Connecticut, Middlesex, East Hampton, perh: :Clark, Betsy (1773–1831)" \f "Place" } in 1773. She reached 58 years of age and died on 9th January 1831.^[89] Betsy was buried in East Hampton{ XE "USA, Connecticut, Middlesex, East Hampton:(41.5759° N, 72.5026° W):Clark, Betsy (1773–1831)" \f "Place" }.^[89]

Betsey (Clark) Strong

Children of Willard Sears and Betsy Clark:

- f I. **Betsy⁵ Sears**{ XE "Sears:Betsy (1797–1850)" \f "Name" \b } was born in East Hampton{ XE "USA, Connecticut, Middlesex, East Hampton:(41.5759° N, 72.5026° W):Sears, Betsy (1797–1850)" \f "Place" } on 23rd March 1797. She died on 16th January 1850, at the age of 52.

Betsy married **Harvey Arnold**{ XE "Arnold:Harvey" \f "Name" \b \i }. They had one son: Edward.

- m II. **Ogden Sears**{ XE "Sears:Ogden (1798–1883)" \f "Name" \b } was born in Chatham{ XE "USA, Connecticut, Middlesex, Chatham: :Sears, Ogden (1798–1883)" \f "Place" } on 19th August 1798.^[89, 93, 94] He died in South Barre, Barre,{ XE "USA, New York, Orleans, Barre, South Barre: :Sears, Ogden (1798–1883)" \f "Place" } on 25th February 1883, at the age of 84.^[89] Ogden was buried in Mt Albion Cemetery, Albion{ XE "USA, New York, Orleans, Albion, Mt Albion Cemetery: :Sears, Ogden (1798–1883)" \f "Place" }.^[89]



Ogden

More facts and events for Ogden Sears:

Residence: 1865	Barre{ XE "USA, New York, Orleans, Barre:(43.1684° N, 78.217° W):Sears, Ogden (1798–1883)" \f "Place" }. ^[93] Relation to Head of House: Head
Residence: 1 st June 1875	Barre{ XE "USA, New York, Orleans, Barre:(43.1684° N, 78.217° W):Sears, Ogden (1798–1883)" \f "Place" }. ^[94] Relation to Head of House: Father

At the age of 21, Ogden married **Betsy Harding**{ XE "Harding:Betsy (1803–)" \f "Name" \b \i } on Wednesday, 1st December 1819, when she was 16 years old.^[93, 94] They had three daughters: Fidelia (1820–1848), Betsy (1823–1893) and Mary (1824–1829).

Betsy was born in perh, East Hampton, Middlesex, Connecticut,{ XE "USA, Connecticut, Middlesex, East Hampton, perh: :Harding, Betsy (1803–)" \f "Place" } on Saturday, 9th July 1803.^[93, 94]

She was the daughter of Daniel Harding{ XE "Harding:Daniel (1777–)" \f "Name" \i } and Betsy Strong{ XE "Strong:Betsy (1781–)" \f "Name" \i }.

- m III. **Willard Sears**{ XE "Sears:Willard (1799–1866)" \f "Name" \b } was born in Chatham{ XE "USA, Connecticut, Middlesex, Chatham: :Sears, Willard (1799–1866)" \f "Place" } on 19th October 1799.^[95] He was known by the title of Capt.

Willard died on 27th August 1866, at the age of 66.^[95] Hartford Daily Post.

Capt Willard Sears married **Sally Young**{ XE "Young:Sally (1802–1838)" \f "Name" \b \i } on Wednesday, 7th June 1820. They had seven children: Lydia (1821–1891), Betsy

⁹³ Ancestry.com, New York, State Census, 1865 (Provo, UT, USA, Ancestry.com Operations, Inc., 2014), Ancestry.com.

⁹⁴ Ancestry.com, New York, State Census, 1875 (Provo, UT, USA, Ancestry.com Operations, Inc., 2013), Ancestry.com.

⁹⁵ Ancestry.com, Connecticut, Deaths and Burials Index, 1650-1934 (Provo, UT, USA, Ancestry.com Operations, Inc., 2011), Ancestry.com.

(1822–1833), Sarah (1824–), Willard (1827–1895), William (1831–1872), Rosetta (1833–) and Mary (1835–1875).

Sally was born in East Hampton{ XE "USA, Connecticut, Middlesex, East Hampton:(41.5759° N, 72.5026° W):Young, Sally (1802–1838)" \f "Place" } in 1802. She reached 36 years of age and died on 14th October 1838. Sally was buried in Lakeside Cemetery, East Hampton{ XE "USA, Connecticut, Middlesex, East Hampton, Lakeside Cemetery: :Young, Sally (1802–1838)" \f "Place" }.

NEHGS Cemetery records-Sally, wife of Capt. Willard Sears, d. ae. 36.

- f IV. **Eunice Sears**{ XE "Sears:Eunice (1801–1875)" \f "Name" \b } was born in East Hampton{ XE "USA, Connecticut, Middlesex, East Hampton:(41.5759° N, 72.5026° W):Sears, Eunice (1801–1875)" \f "Place" } on 11th May 1801. She died on 10th June 1875, at the age of 74.

Eunice Sears married **Henry Snow**{ XE "Snow:Henry" \f "Name" \b \i }. They had one son: Henry.

- m V. **Stephen Griffith Sears**{ XE "Sears:Stephen Griffith (1803–1874)" \f "Name" \b } was born in Chatham{ XE "USA, Connecticut, Middlesex, Chatham: :Sears, Stephen Griffith (1803–1874)" \f "Place" } on 27th September 1803.^[89, 95] He was known by the title of Dea.



Stephen

Stephen Griffith died in East Hampton{ XE "USA, Connecticut, Middlesex, East Hampton:(41.5759° N, 72.5026° W):Sears, Stephen Griffith (1803–1874)" \f "Place" } on 12th October 1874, at the age of 71.^[89, 95] He was buried in Lakeside Cemetery, East Hampton{ XE "USA, Connecticut, Middlesex, East Hampton, Lakeside Cemetery: :Sears, Stephen Griffith (1803–1874)" \f "Place" }.^[89]

At the age of 27, Stephen Griffith married **Emily Veazey**{ XE "Veazey:Emily (1805–1879)" \f "Name" \b \i } on Tuesday, 3rd May 1831, in Chatham{ XE "USA, Connecticut, Middlesex, Chatham: :Sears, Stephen Griffith (1803–1874)" \f "Place" } when she was 26 years old.^[89] They had four children: Mary (1835–1875), Clark (1836–1891), Cushman (1838–1919) and Carrie (1843–1923).

Emily was born in East Hampton{ XE "USA, Connecticut, Middlesex, East Hampton:(41.5759° N, 72.5026° W):Veazey, Emily (1805–1879)" \f "Place" } on Thursday, 14th February 1805.^[89]

She was the daughter of Eleazar Veazey{ XE "Veazey:Eleazar (1779–)" \f "Name" \i } and Elizabeth West{ XE "West:Elizabeth (1783–)" \f "Name" \i }. Emily reached 74 years of age and died in East Hampton{ XE "USA, Connecticut, Middlesex, East Hampton:(41.5759° N, 72.5026° W):Veazey, Emily (1805–1879)" \f "Place" } on 3rd April 1879.^[89] She was buried in East Hampton{ XE "USA, Connecticut, Middlesex, East Hampton:(41.5759° N, 72.5026° W):Veazey, Emily (1805–1879)" \f "Place" }.^[89]

- m VI. **Elijah Clark Sears**{ XE "Sears:Elijah Clark (1805–1910)" \f "Name" \b } was born in Chatham{ XE "USA, Connecticut, Middlesex, Chatham: :Sears, Elijah Clark (1805–1910)" \f "Place" } on 23rd June 1805.^[88, 89, 96, 97–98] He died in Lincoln{ XE "USA, South Dakota, Lincoln:(43.2794° N, 96.7219° W):Sears, Elijah Clark (1805–1910)" \f "Place" } on 31st December 1910, at the age of 105.^[89, 98] Elijah Clark was buried in Canton, Lincoln County{ XE "USA, South Dakota, Lincoln County, Canton:(43.3008° N, 96.5925° W):Sears, Elijah Clark (1805–1910)" \f "Place" }.^[89]



Elijah

⁹⁶ Ancestry.com, 1910 United States Federal Census (Provo, UT, USA, Ancestry.com Operations Inc, 2006), Ancestry.com, Year: 1910; Census Place: Canton Ward 2, Lincoln, South Dakota; Roll: T624_1484; Page: 2B; Enumeration District: 0276; FHL microfilm: 1375497.

⁹⁷ Ancestry.com, Connecticut, Town Marriage Records, pre-1870 (Barbour Collection) (Provo, UT, USA, Ancestry.com Operations Inc, 2006), Ancestry.com.

⁹⁸ Ancestry.com, South Dakota, Death Index, 1879-1955 (Provo, UT, USA, Ancestry.com Operations, Inc., 2004), Ancestry.com.

More facts and events for Elijah Clark Sears:

- Residence: 1830 Camden, Oneida, New York{ XE "USA, New York, Oneida, Camden:(43.3345° N, 75.748° W):Sears, Elijah Clark (1805–1910)" \f "Place" }
- Residence: 1900 Canton, Lincoln, South Dakota{ XE "USA, South Dakota, Lincoln, Canton:(43.3008° N, 96.5925° W):Sears, Elijah Clark (1805–1910)" \f "Place" }
- Residence: 1910 Ward 2, Canton{ XE "USA, South Dakota, Lincoln, Canton, Ward 2: :Sears, Elijah Clark (1805–1910)" \f "Place" }^[96]
Marital Status: Widowed; Relation to Head of House: Father
- Residence: 1910 Ward 2{ XE "USA, South Dakota, Lincoln, Canton, Ward 2: :Sears, Elijah Clark (1805–1910)" \f "Place" }
- Residence: Chatham^[97]

Elijah Clark Sears married **Ann Bliss Hills**{ XE "Hills:Ann Bliss (1808–1875)" \f "Name" \b \i } on Sunday, 24th December 1826, in Chatham, Connecticut{ XE "USA, Connecticut, Chatham: :Sears, Elijah Clark (1805–1910)" \f "Place" }.^[97] They had six children: Francis (1827–1921), Caroline (1829–1899), James (1831–), John (1834–1905), Amanda (1837–) and Mary (1843–1913).

Ann Bliss was born in perh{ XE "USA, Connecticut, perh: :Hills, Ann Bliss (1808–1875)" \f "Place" } in 1808.

She was the daughter of David Hills{ XE "Hills:David" \f "Name" \i }. Ann Bliss reached 67 years of age and died in Crystal Lake, McHenry, Illinois,{ XE "USA, Illinois, McHenry, Crystal Lake:(42.2411° N, 88.3162° W):Hills, Ann Bliss (1808–1875)" \f "Place" } in 1875.

- m VII. **Selden Philo Sears**{ XE "Sears:Selden Philo (1813–1900)" \f "Name" \b } was born in Chatham{ XE "USA, Connecticut, Middlesex, Chatham: :Sears, Selden Philo (1813–1900)" \f "Place" } on 21st July 1813.^[89, 90, 97, 99] He died on 10th January 1900, at the age of 86.^[89] Selden Philo was buried in West Hartford, Hartford County{ XE "USA, Connecticut, Hartford County, West Hartford:(41.762° N, 72.742° W):Sears, Selden Philo (1813–1900)" \f "Place" }.^[89]



More facts and events for Selden Philo Sears:

- Residence: Chatham^[97]

At the age of 30, Selden Philo Sears married **Eveline Dickinson**{ XE "Dickinson:Eveline (1813–)" \f "Name" \b \i } on Wednesday, 29th November 1843, in Marlborough, Hartford,{ XE "USA, Connecticut, Hartford, Marlborough:(41.6314° N, 72.4603° W):Sears, Selden Philo (1813–1900)" \f "Place" } when she was 30 years old.^[97, 99] They had four children: Prescott (1846–1921), Newman (1848–1930), Alida (1852–1877) and David (1854–1879).

Eveline was born in Marlborough{ XE "USA, Connecticut, Hartford, Marlborough:(41.6314° N, 72.4603° W):Dickinson, Eveline (1813–)" \f "Place" } on Thursday, 6th May 1813.

⁹⁹ Ancestry.com, Massachusetts, Marriage Records, 1840-1915 (Provo, UT, USA, Ancestry.com Operations, Inc., 2013), Ancestry.com, New England Historic Genealogical Society; Boston, Massachusetts; Massachusetts Vital Records, 1911-1915.

Family of Ruth Sears and Joshua Bailey{ TC "Ruth Sears and Joshua Bailey" \I 3 \f C}

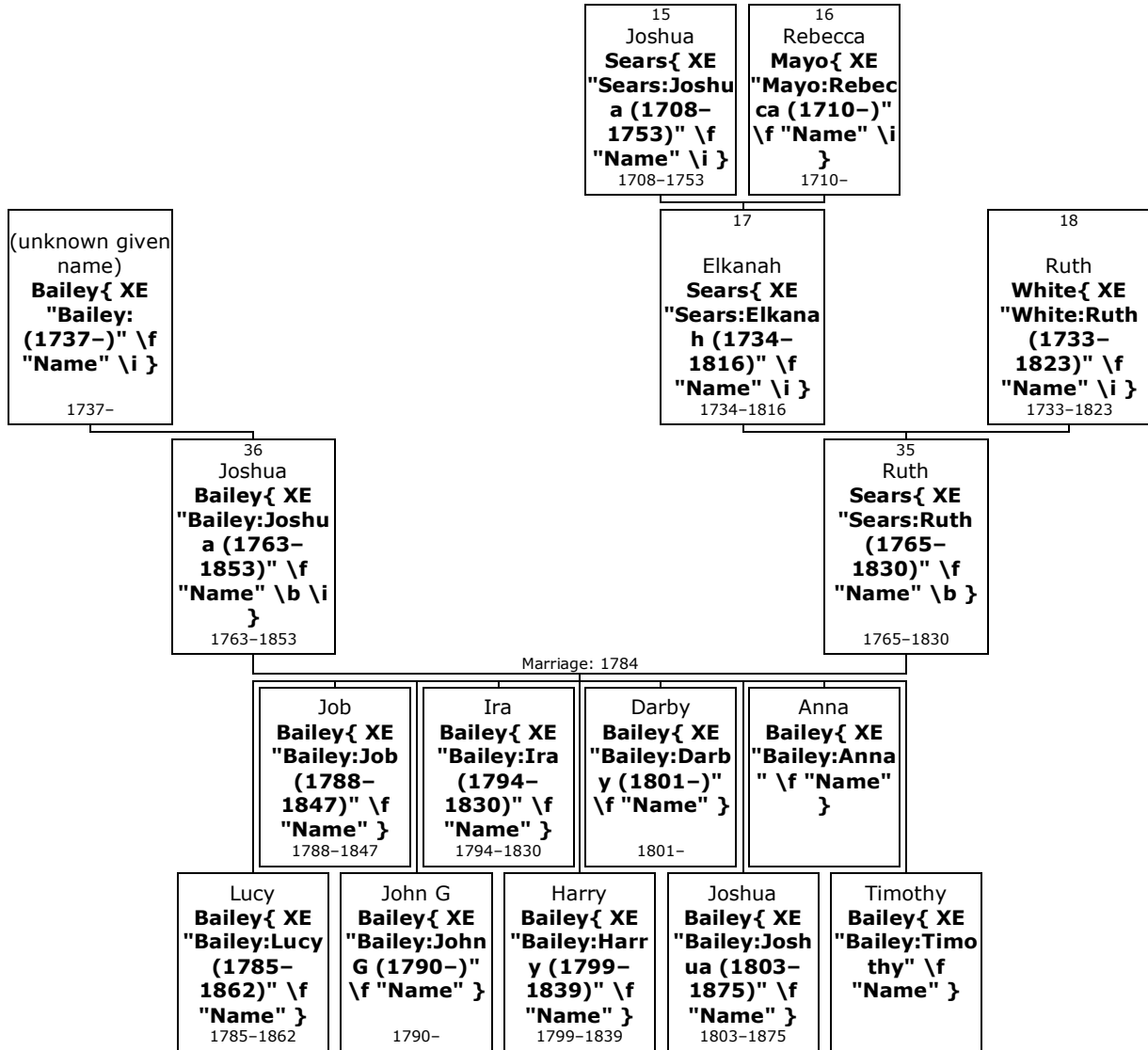

35. **Ruth⁴ Sears**{ XE "Sears:Ruth (1765-1830)" \f "Name" \b } (*Capt Elkanah³, Joshua²*) was born on Thursday, 21st March 1765, in Easthampton, Hampshire, Massachusetts, USA{ XE "USA, Massachusetts, Hampshire, Easthampton:(42.2668° N, 72.669° W):Sears, Ruth (1765-1830)" \f "Place" }. She was the daughter of Elkanah Sears{ XE "Sears:Elkanah (1734-1816)" \f "Name" \i } (17) and Ruth White{ XE "White:Ruth (1733-1823)" \f "Name" \i } (18).

Ruth was christened on 5th March 1825. She died in Meredith, Delaware, New York,{ XE "USA, New York, Delaware, Meredith:(42.3583° N, 74.9348° W):Sears, Ruth (1765-1830)" \f "Place" } in 1830 at the age of 64. Ruth was buried. Meredith Baptist Cemetery.

!S P May No 528 p.135 One of her sons was the inventor of the machine for weaving under-wear, and d. in Cohoes or vicinity. Lorelei Maison Rockwell additional children !Mayflower Index: No. 30019; spouse Joshua Bailey; father Elkanah

36. At the age of 19, Ruth married **Joshua Bailey**{ XE "Bailey:Joshua (1763-1853)" \f "Name" \b \i } on Friday, 5th November 1784, when he was 21 years old. They had nine children: Lucy (1785-1862), Job (1788-1847), John (1790-), Ira (1794-1830), Harry (1799-1839), Darby (1801-), Joshua (1803-1875), Anna and Timothy.

Joshua was born in East Hampton, Middlesex, Connecticut,{ XE "USA, Connecticut, Middlesex, East Hampton:(41.5759° N, 72.5026° W):Bailey, Joshua (1763-1853)" \f "Place" } on Tuesday, 21st June 1763. He was the son of (unknown given name) Bailey{ XE "Bailey: (1737-)\" \f "Name" \i }.

He was christened on 6th May 1764. Joshua reached 89 years of age and died in Cohoes, Albany, New York, { XE "USA, New York, Albany, Cohoes:(42.7742° N, 73.7001° W):Bailey, Joshua (1763–1853)" \f "Place" } on 16th January 1853.

!Joined church 9 Mar 1794 profession/ 1807 dismissal res perhaps Haddam Chatham CT; Delaware & Saratoga co, NY According to History of Delaware co, NY, 1856, p.426 Joshua Bailey, among others, signed as member of "The Social League" -- 1st temperance society in county. The Society was also against gambling, and "excesses that lead to disgrace!" Mr Bailey was born in E Hampton, CT, in 1763, removed to Meredith, Delaware co in 1803, and lived in a log cabin seven years, enduring hardships and privation incident to the life of a pioneer. he removed from Meredith to Cohoes in 1835, where he continued to reside with his son Joshua until the day of his death.

Children of Ruth Sears and Joshua Bailey:

- f I. **Lucy⁵ Bailey**{ XE "Bailey:Lucy (1785–1862)" \f "Name" \b } was born between 1785 and 1786. She was christened in Chatham, Middlesex, Connecticut, { XE "USA, Connecticut, Middlesex, Chatham: :Bailey, Lucy (1785–1862)" \f "Place" } in May 1794. Lucy died in Michigan { XE "USA, Michigan:(44.5917° N, 85.025° W):Bailey, Lucy (1785–1862)" \f "Place" } in 1862.
- Lucy married **Jonathan Brainard**{ XE "Brainard:Jonathan (1784–)" \f "Name" \b \i } on Wednesday, 24th December 1806, in prob Chatham, Middlesex, Connecticut { XE "USA, Connecticut, Middlesex, prob Chatham: :Bailey, Lucy (1785–1862)" \f "Place" }. They had eleven children: Hope (1807–1877), John (1808–), Harley (1810–), Matilda (1812–), Leva (1813–1894), Mary (1815–), Clarissa (1817–1880), Esther (1819–), Amasa (1821–1891), Charles (1823–) and Sally (1825–).
- Jonathan was born in Middle Haddam { XE "USA, Connecticut, Middlesex, Middle Haddam:(41.5539° N, 72.5506° W):Brainard, Jonathan (1784–)" \f "Place" } on Wednesday, 24th November 1784.
- m II. **Job Bailey**{ XE "Bailey:Job (1788–1847)" \f "Name" \b } was born in Chatham, Middlesex, Connecticut, { XE "USA, Connecticut, Middlesex, Chatham: :Bailey, Job (1788–1847)" \f "Place" } on 25th October 1788. He died on 4th March 1847, at the age of 58.
- Job Bailey married **Bethana --Bailey**{ XE "--Bailey:Bethana (1794–1849)" \f "Name" \b \i } in 1812. They had no known children.
- Bethana was born in 1794. She reached 55 years of age and died in 1849.
- m III. **John G Bailey**{ XE "Bailey:John G (1790–)" \f "Name" \b } was born in 1790.
- m IV. **Ira Bailey**{ XE "Bailey:Ira (1794–1830)" \f "Name" \b } was born in 1794. He died on 19th January 1830, at the age of 36.
- m V. **Harry Bailey**{ XE "Bailey:Harry (1799–1839)" \f "Name" \b } was born in 1799. He died on 2nd August 1839, at the age of 40.
- m VI. **Darby Bailey**{ XE "Bailey:Darby (1801–)" \f "Name" \b } was born in Meredith, Delaware, New York, { XE "USA, New York, Delaware, Meredith:(42.3583° N, 74.9348° W):Bailey, Darby (1801–)" \f "Place" } in 1801.
- m VII. **Joshua Bailey**{ XE "Bailey:Joshua (1803–1875)" \f "Name" \b } was born in Meredith { XE "USA, New York, Delaware, Meredith:(42.3583° N, 74.9348° W):Bailey, Joshua (1803–1875)" \f "Place" } in 1803. He was christened in Chatham, Middlesex, Connecticut, { XE "USA, Connecticut, Middlesex, Chatham: :Bailey, Joshua (1803–1875)" \f "Place" } on 26th October 1800. Joshua died in Waterford, Saratoga, New York, { XE "USA, New York, Saratoga, Waterford:(42.7926° N, 73.6812° W):Bailey, Joshua (1803–1875)" \f "Place" } on 21st January 1875, at the age of 72.
- Joshua Bailey married **Almira Miller**{ XE "Miller:Almira (1804–1862)" \f "Name" \b \i }. They had no known children.
- Almira was born on Monday, 20th February 1804. She was the daughter of William Miller { XE "Miller:William" \f "Name" \i } and Esther Kilborn { XE "Kilborn:Esther" \f "Name" \i }. Almira reached 57 years of age and died in 1862.
- f VIII. **Anna Bailey**{ XE "Bailey:Anna" \f "Name" \b }. Anna was christened in Chatham, Middlesex, Connecticut, { XE "USA, Connecticut, Middlesex, Chatham: :Bailey, Anna" \f "Place" } on 9th April 1797.

m IX. **Timothy Bailey**{ XE "Bailey:Timothy" \f "Name" \b }. Timothy was christened in Chatham, Middlesex, Connecticut,{ XE "USA, Connecticut, Middlesex, Chatham: :Bailey, Timothy" \f "Place" } on 11th May 1794.

Timothy Bailey married **Hannah --Bailey**{ XE "--Bailey:Hannah (1798-)" \f "Name" \b \i }. They had no known children.

Hannah was born in Chatham{ XE "USA, Connecticut, Middlesex, Chatham: :--Bailey, Hannah (1798-)" \f "Place" } in 1798.

Family of Rachel Sears and Nathaniel Bailey{ TC "Rachel Sears and Nathaniel Bailey" \I 3 \f C}

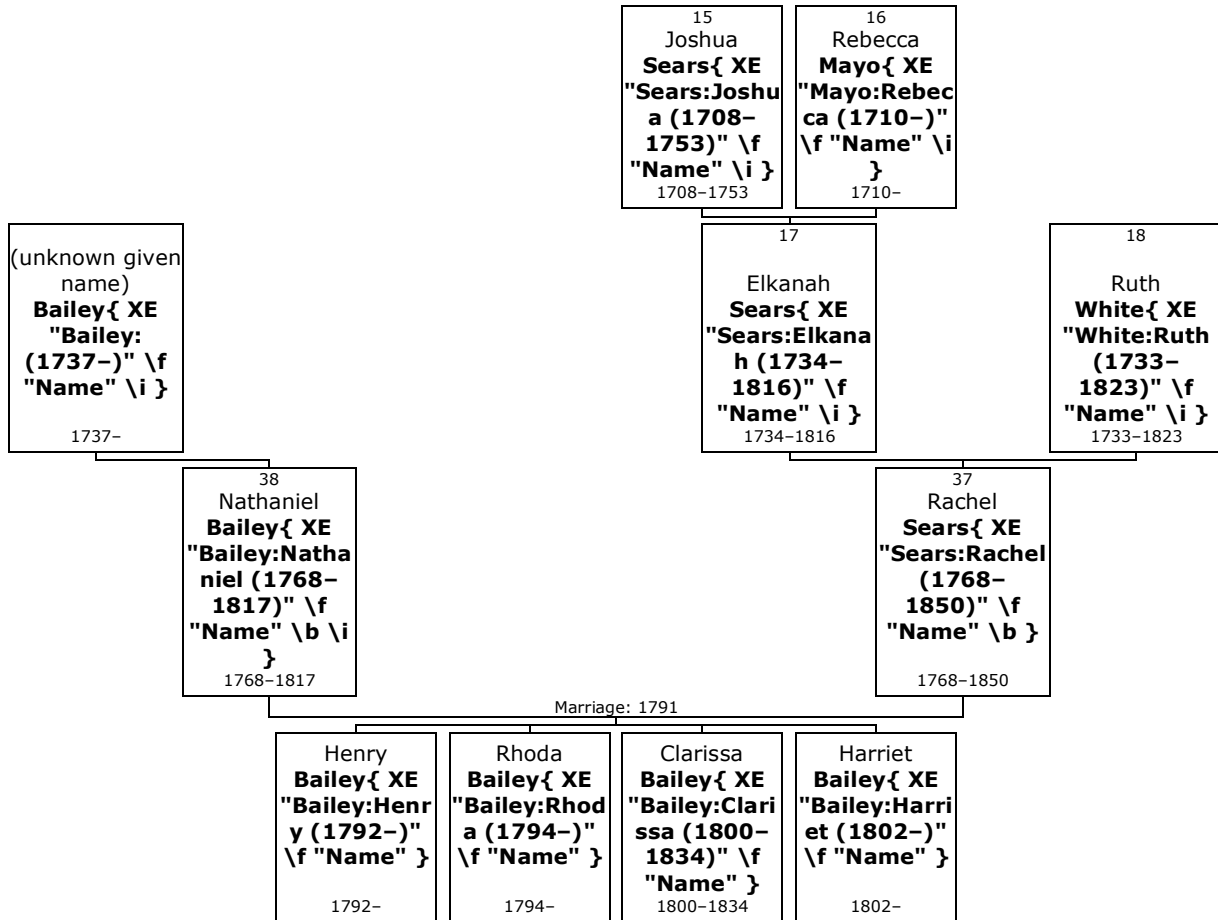

37. **Rachel⁴ Sears**{ XE "Sears:Rachel (1768-1850)" \f "Name" \b } (*Capt Elkanah³, Joshua²*) was born on Friday, 9th September 1768, in East Hampton, Middlesex, Connecticut, USA{ XE "USA, Connecticut, Middlesex, East Hampton:(41.5759° N, 72.5026° W):Sears, Rachel (1768-1850)" \f "Place" }. She was the daughter of Elkanah Sears{ XE "Sears:Elkanah (1734-1816)" \f "Name" \i } (17) and Ruth White{ XE "White:Ruth (1733-1823)" \f "Name" \i } (18).

Rachel was christened on 9th October 1768. She died on 19th September 1850, at the age of 82.

!S P May (No 529) !Rachel; spouse Nathaniel Bailey; father Elkanah-Mayflower Index: No. 30,012

38. Rachel married **Nathaniel Bailey**{ XE "Bailey:Nathaniel (1768-1817)" \f "Name" \b \i } on Sunday, 20th November 1791. They had four children: Henry (1792-), Rhoda (1794-), Clarissa (1800-1834) and Harriet (1802-).

Nathaniel was born in perh{ XE "USA, Connecticut, Middlesex, perh: :Bailey, Nathaniel (1768-1817)" \f "Place" } in 1768. He was the son of (unknown given name) Bailey{ XE "Bailey: (1737-)" \f "Name" \i }.

Nathaniel reached 49 years of age and died on 1st September 1817. Drowned/Mill Pond.

Children of Rachel Sears and Nathaniel Bailey:

m I. **Henry⁵ Bailey**{ XE "Bailey:Henry (1792-)" \f "Name" \b } was born in perh, East Hampton,{ XE "USA, Connecticut, Middlesex, East Hampton, perh: :Bailey, Henry (1792-)" \f "Place" } in 1792.

- f II. **Rhoda Bailey**{ XE "Bailey:Rhoda (1794-)" \f "Name" \b } was born in perh{ XE "USA, Connecticut, Middlesex, East Hampton, perh: :Bailey, Rhoda (1794-)" \f "Place" } in 1794.
Rhoda married **Henry Robert**{ XE "Robert:Henry" \f "Name" \b \i }.
- f III. **Clarissa Bailey**{ XE "Bailey:Clarissa (1800-1834)" \f "Name" \b } was born in perh{ XE "USA, Connecticut, Middlesex, East Hampton, perh: :Bailey, Clarissa (1800-1834)" \f "Place" } on 19th April 1800. She died on 26th October 1834, at the age of 34.
Clarissa married **William Wadsworth Richmond**{ XE "Richmond:William Wadsworth (1797-)" \f "Name" \b \i }. They had five children: William (1821-), Harriet (1823-), Emily (1826-1858), Frances (1828-1857) and Albert (1831-1868).
William Wadsworth was born in perh, Marlborough, Hartford,{ XE "USA, Connecticut, Hartford, Marlborough, perh: :Richmond, William Wadsworth (1797-)" \f "Place" } on Friday, 27th October 1797. He was the son of John Richmond{ XE "Richmond:John" \f "Name" \i } and Prudence Wadsworth{ XE "Wadsworth:Prudence" \f "Name" \i }.
- f IV. **Harriet Bailey**{ XE "Bailey:Harriet (1802-)" \f "Name" \b } was born in perh{ XE "USA, Connecticut, Middlesex, East Hampton, perh: :Bailey, Harriet (1802-)" \f "Place" } in 1802.
Harriet married **Alfred Williams**{ XE "Williams:Alfred" \f "Name" \b \i }.

Family of Benjamin Sears and Ann Bigelow{ TC "Benjamin Sears and Ann Bigelow" \I 3 \f C}

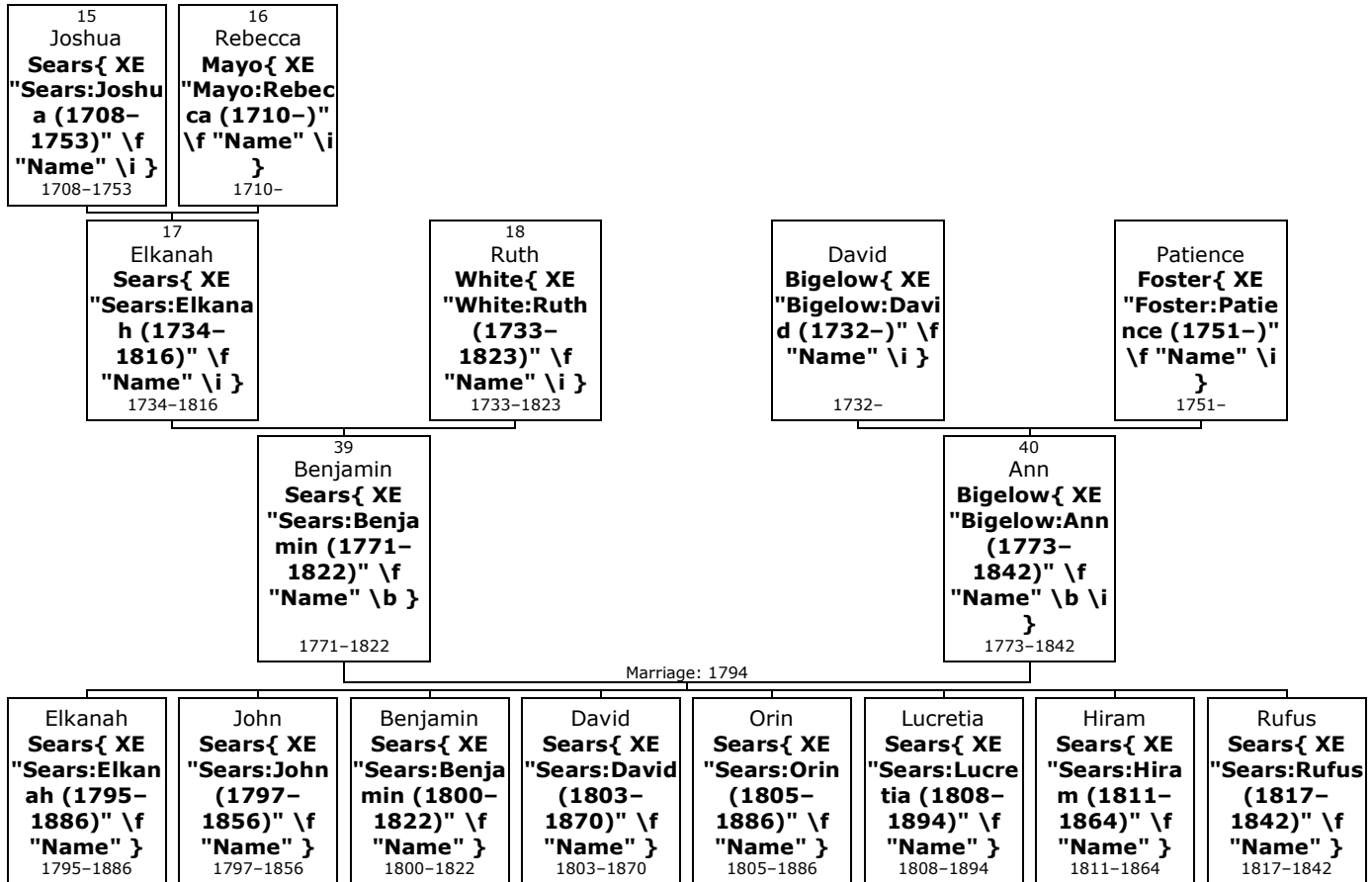

39. **Rev Benjamin⁴ Sears**{ XE "Sears:Benjamin (1771-1822)" \f "Name" \b } (*Capt Elkanah³, Joshua²*) was born on Thursday, 21st February 1771, in Chatham, Middlesex, Connecticut, USA{ XE "USA, Connecticut, Middlesex, Chatham: :Sears, Benjamin (1771-1822)" \f "Place" }.^[100, 101, 102, 103, 104-105] He was the son of

¹⁰⁰ Ancestry.com, U.S., Find A Grave Index, 1600s-Current (Provo, UT, USA, Ancestry.com Operations, Inc., 2012), Ancestry.com.

¹⁰¹ Ancestry.com, Web: Ohio, Find A Grave Index, 1787-2012 (Provo, UT, USA, Ancestry.com Operations, Inc., 2012), Ancestry.com.

Elkanah Sears{ XE "Sears:Elkanah (1734–1816)" \f "Name" \i } (17) and Ruth White{ XE "White:Ruth (1733–1823)" \f "Name" \i } (18).

Benjamin died in Delaware, Ohio,{ XE "USA, Ohio, Delaware:(40.2783° N, 83.0074° W):Sears, Benjamin (1771–1822)" \f "Place" } on 11th October 1822, at the age of 51.^[100–103] He was buried in Bucyrus, Crawford{ XE "USA, Ohio, Crawford, Bucyrus:(40.8084° N, 82.9755° W):Sears, Benjamin (1771–1822)" \f "Place" }.^[100, 101]

<https://www.wikitree.com/wiki/Sears-2826>

!S.P. May p.226, No 530, "In early life Benjamin Sears followed farming and coopering, with his father; rem. from Chatham, CT, to New Durham, Greene co, NY, and thence after two years, he penetrated the forest still further, to Delaware, OH, where he resided till his death.

He filled with honor and esteem various military offices.

Changing his views of the Christian religion, he joined the Baptist Church, devoted himself to the ministry, received ordination, and after serving his church for some years, to its great increase, took his leave for a more extended field. He received his appointment as missionary, and traveling with his two sons, John and Benjamin, and John's wife, he went to Fort Wayne, IN, his sons having received appointments to labor as missionaries among the Indians. He returned from the mission to Delaware, and died soon afterward, much lamented as a man of energy and piety.

BURIAL: Email from Lynne Sears, Jeromesville, OH; 1851-1955; Letter dtd 25 Jan 1996; ; elksears@aol.com; ; BURIAL: Oakwood Cemetery Lot D2;

!Mayflower Index: No. 29,899 Benjamin; spouse Ann Bigelow; father Elkanah

- 40.** At the age of 22, Benjamin married **Ann Bigelow**{ XE "Bigelow:Ann (1773–1842)" \f "Name" \b \i } on Sunday, 2nd February 1794, when she was 21 years old.^[100, 102, 103] They had eight children: Elkanah (1795–1886), John (1797–1856), Benjamin (1800–1822), David (1803–1870), Orin (1805–1886), Lucretia (1808–1894), Hiram (1811–1864) and Rufus (1817–1842).

Ann was born in Marlborough, Hartford, Connecticut,{ XE "USA, Connecticut, Hartford, Marlborough:(41.6314° N, 72.4603° W):Bigelow, Ann (1773–1842)" \f "Place" } on Friday, 15th January 1773.^[100, 102, 103] She was the daughter of David Bigelow{ XE "Bigelow:David (1732–)" \f "Name" \i } and Patience Foster{ XE "Foster:Patience (1751–)" \f "Name" \i }.

Ann reached 69 years of age and died in Mecklenburg, Schuyler, New York,{ XE "USA, New York, Schuyler, Mecklenburg:(42.4575° N, 76.7106° W):Bigelow, Ann (1773–1842)" \f "Place" } on 14th May 1842.^[100, 102, 103] She was buried in Hector{ XE "USA, New York, Schuyler, Hector:(42.5006° N, 76.8728° W):Bigelow, Ann (1773–1842)" \f "Place" }.^[100]

!listed as Anna in the Bigelow genealogy

Children of Benjamin Sears and Ann Bigelow:

- m I. **Elkanah⁵ Sears**{ XE "Sears:Elkanah (1795–1886)" \f "Name" \b } was born in New Durham, Greene,{ XE "USA, New York, Greene, New Durham: :Sears, Elkanah (1795–1886)" \f "Place" } on 22nd June 1795.^[100, 103] He died in East Rockport, Rockport, Cuyahoga, Ohio,{ XE "USA, Ohio, Cuyahoga, Rockport, East Rockport: :Sears, Elkanah (1795–1886)" \f "Place" } on 15th November 1886, at the age of 91.^[100, 103] Elkanah was buried in Bucyrus, Crawford{ XE "USA, Ohio, Crawford, Bucyrus:(40.8084° N, 82.9755° W):Sears, Elkanah (1795–1886)" \f "Place" }.^[100]



Elkanah

¹⁰² Ancestry.com, U.S., Sons of the American Revolution Membership Applications, 1889-1970 (Provo, UT, USA, Ancestry.com Operations, Inc., 2011), Ancestry.com, SAR Membership Number: 93072. [Source citation includes one media item]

¹⁰³ Ancestry.com, North America, Family Histories, 1500-2000 (Provo, UT, USA, Ancestry.com Operations, Inc., 2016), Ancestry.com, Book Title: Lineage Book : NSDAR : Volume 106 : 1913. [Source citation includes one media item]

¹⁰⁴ Ancestry.com, Connecticut, Church Record Abstracts, 1630-1920 (Provo, UT, USA, , 2013), Ancestry.com. [Source citation includes one media item]

¹⁰⁵ Ancestry.com, Connecticut Town Birth Records, pre-1870 (Barbour Collection) (Provo, UT, USA, Ancestry.com Operations Inc, 2006), Ancestry.com. [Source citation includes one media item]

At the age of 24, Elkanah married **Desiar Phelps**{ XE "Phelps:Desiar (1794-1872)" \f "Name" \b \i } on Tuesday, 21st March 1820, in Franklin, New York,{ XE "USA, New York, Franklin:(44.6003° N, 74.3091° W):Sears, Elkanah (1795-1886)" \f "Place" } when she was 25 years old.^[100] They had four children: John (1821-1912), Benjamin (1824-1917), Arminda (1828-1829) and Cyrus (1832-1909).

Desiar was born in Hebron, Tolland, Connecticut,{ XE "USA, Connecticut, Tolland, Hebron:(41.6579° N, 72.3659° W):Phelps, Desiar (1794-1872)" \f "Place" } on Friday, 12th September 1794.^[100] She was the daughter of Obadiah Phelps{ XE "Phelps:Obadiah (1768-)" \f "Name" \i } and Arminda Phelps{ XE "Phelps:Arminda (1772-)" \f "Name" \i }.

Desiar reached 78 years of age and died on 21st September 1872.^[100] She was buried in Bucyrus, Crawford, Ohio{ XE "USA, Ohio, Crawford, Bucyrus:(40.8084° N, 82.9755° W):Phelps, Desiar (1794-1872)" \f "Place" }.^[100]

!BURIAL: Email from Lynne Sears, Jeromesville, OH; 1851-1955; Letter dtd 25 jan 1996; ; ; BURIAL: Oakwood Cemetery Lot D2;

elksears@aol.com

!

!SPM No 2237

- m II. **John Sears**{ XE "Sears:John (1797-1856)" \f "Name" \b } was born in New Durham{ XE "USA, New York, New Durham: :Sears, John (1797-1856)" \f "Place" } on 20th April 1797.^[106, 107] He was also known as **John Sears**{ XE "Sears:John (John Sears) (1797-1856)" \f "Name" }.^[106]

John was known by the title of Rev. He died in Lake Zurich, Lake, Illinois,{ XE "USA, Illinois, Lake, Lake Zurich:(42.197° N, 88.0934° W):Sears, John (1797-1856)" \f "Place" } on 14th November 1856, at the age of 59.

Rev John Sears married **Mary Ann Slater**{ XE "Slater:Mary Ann (1798-1871)" \f "Name" \b \i } in May 1822 in New York{ XE "USA, New York:(42.7531° N, 74.2224° W):Sears, John (1797-1856)" \f "Place" }.^[106-108] They had eight children: Eliza (1823-1905), Mary (1824-1918), Ann (1826-1899), John (1828-1878), Lucy (1830-1911), Sarah (1833-1911), Harriet (1836-1929) and Asa (1838-1916).

Mary Ann was born in Rhinebeck, Dutchess, New York,{ XE "USA, New York, Dutchess, Rhinebeck:(41.9268° N, 73.9126° W):Slater, Mary Ann (1798-1871)" \f "Place" } in 1798. She reached 73 years of age and died in Detroit, Wayne, Michigan,{ XE "USA, Michigan, Wayne, Detroit:(42.3314° N, 83.0458° W):Slater, Mary Ann (1798-1871)" \f "Place" } on 2nd July 1871.

- m III. **Benjamin Sears**{ XE "Sears:Benjamin (1800-1822)" \f "Name" \b } was born in New Durham, Durham, Greene,{ XE "USA, New York, Greene, Durham, New Durham: :Sears, Benjamin (1800-1822)" \f "Place" } on 16th June 1800. He was christened in 1815. Benjamin died in Fort Wayne, Allen, Indiana,{ XE "USA, Indiana, Allen, Fort Wayne:(41.1306° N, 85.1289° W):Sears, Benjamin (1800-1822)" \f "Place" } on 24th November 1822, at the age of 22.

- m IV. **David Sears**{ XE "Sears:David (1803-1870)" \f "Name" \b } was born in Meredith, Delaware,{ XE "USA, New York, Delaware, Meredith:(42.3583° N, 74.9348° W):Sears, David (1803-1870)" \f "Place" } on 17th July 1803.^[109] He died in Maquoketa, Jackson,

¹⁰⁶ Ancestry.com, U.S., Newspaper Extractions from the Northeast, 1704-1930 (Provo, UT, USA, Ancestry.com Operations, Inc., 2014), Ancestry.com, Record for Rev John Sears.
<http://search.ancestry.com/cgi-bin/sse.dll?db=50015&h=660701&indiv=try>.

¹⁰⁷ Ancestry.com, Michigan, Death Records, 1897-1920 (Provo, UT, USA, Ancestry.com Operations, Inc., 2010), Ancestry.com, The Library of Michigan; Michigan Death Records Project; Rolls: 1-302; Archive Barcode/Item Number: 30000008533154; Roll Number: 223; Certificate Number: 12.

¹⁰⁸ Ancestry.com, U.S., Newspaper Extractions from the Northeast, 1704-1930 (Provo, UT, USA, Ancestry.com Operations, Inc., 2014), Ancestry.com.
[Source citation includes one media item]

¹⁰⁹ Ancestry.com, North America, Family Histories, 1500-2000 (Provo, UT, USA, Ancestry.com Operations, Inc., 2016), Ancestry.com, Book Title: Wheat Genealogy : A history of the Wheat Family in America : with a brief account of the name and family in England and Normandy : Volume 1 : 1903.

Iowa,{ XE "USA, Iowa, Jackson, Maquoketa:(42.0689° N, 90.6657° W):Sears, David (1803–1870)" \f "Place" } on 15th April 1870, at the age of 66.^[109]

At the age of 23, David Sears married **Maria Wheat**{ XE "Wheat: Maria (1799–1875)" \f "Name" \b \i } on Tuesday, 12th June 1827, when she was 27 years old.^[100, 109, 110] They had six children: Susan (1830–1900), George (1832–1915), William (1832–1904), Benjamin (1834–1913), Sylvester (1837–1838) and Mary (1839–1841).

Maria was born in Marlboro, Ulster, New York,{ XE "USA, New York, Ulster, Marlboro:(41.6057° N, 73.9715° W):Wheat, Maria (1799–1875)" \f "Place" } on Wednesday, 19th June 1799.^[100, 109, 110] She was the daughter of William Wheat{ XE "Wheat: William (1772–1868)" \f "Name" \i } and Mary Bolles{ XE "Bolles: Mary (–1839)" \f "Name" \i }.

Maria reached 76 years of age and died in Maquoketa, Jackson, Iowa,{ XE "USA, Iowa, Jackson, Maquoketa:(42.0689° N, 90.6657° W):Wheat, Maria (1799–1875)" \f "Place" } on 4th August 1875.^[100, 109, 110] She was buried in Maquoketa, Jackson County{ XE "USA, Iowa, Jackson County, Maquoketa:(42.0689° N, 90.6657° W):Wheat, Maria (1799–1875)" \f "Place" }.^[100, 110]

- m V. **Orin Sears**{ XE "Sears: Orin (1805–1886)" \f "Name" \b } was born in Meredith{ XE "USA, New York, Delaware, Meredith:(42.3583° N, 74.9348° W):Sears, Orin (1805–1886)" \f "Place" } on 12th December 1805.^[100, 111] He was known by the title of Deacon.

Orin died in near, Mecklenburg,{ XE "USA, New York, Schuyler, Mecklenburg, near: :Sears, Orin (1805–1886)" \f "Place" } on 14th January 1886, at the age of 80.^[100] He was buried in Hector{ XE "USA, New York, Schuyler, Hector:(42.5006° N, 76.8728° W):Sears, Orin (1805–1886)" \f "Place" }.^[100]

More facts and events for Orin Sears:

Residence: 1855 Hector{ XE "USA, New York, Schuyler, Hector:(42.5006° N, 76.8728° W):Sears, Orin (1805–1886)" \f "Place" }.^[111]
Relation to Head of House: Head

Deacon Orin Sears married **Jennette Mitchell**{ XE "Mitchell: Jennette (1807–1871)" \f "Name" \b \i } on Thursday, 7th February 1828.^[100, 111] They had seven children: Jane (1829–), Isaac (1831–1910), Preston (1834–1899), Eliza (1837–1839), Anne (1841–), Sarah (1844–) and Ruth (1849–).

Jennette was born in New York{ XE "USA, New York:(42.7531° N, 74.2224° W):Mitchell, Jennette (1807–1871)" \f "Place" } in 1807.^[100, 111] She reached 64 years of age and died in New York{ XE "USA, New York:(42.7531° N, 74.2224° W):Mitchell, Jennette (1807–1871)" \f "Place" } on 28th September 1871.^[100] Jennette was buried in Hector, Schuyler, New York{ XE "USA, New York, Schuyler, Hector:(42.5006° N, 76.8728° W):Mitchell, Jennette (1807–1871)" \f "Place" }.^[100]

- f VI. **Lucretia Sears**{ XE "Sears: Lucretia (1808–1894)" \f "Name" \b } was born in Meredith{ XE "USA, New York, Delaware, Meredith:(42.3583° N, 74.9348° W):Sears, Lucretia (1808–1894)" \f "Place" } in 1808.^[100, 102] She died in Cocoa, Brevard, Florida,{ XE "USA, Florida, Brevard, Cocoa:(28.3861° N, 80.742° W):Sears, Lucretia (1808–1894)" \f "Place" } in 1894 at the age of 86.^[100, 102] Lucretia was buried in New Haven, New Haven, Connecticut{ XE "USA, Connecticut, New Haven, New Haven:(41.3082° N, 72.9281° W):Sears, Lucretia (1808–1894)" \f "Place" }.^[100]



Lucretia

¹¹⁰ Ancestry.com, Iowa, Cemetery Records, 1662-1999 (Provo, UT, USA, Ancestry.com Operations Inc, 2000), Ancestry.com.

¹¹¹ Ancestry.com, New York, State Census, 1855 (Provo, UT, USA, Ancestry.com Operations, Inc., 2013), Ancestry.com.

Lucretia Sears married **Harvey Munson**{ XE "Munson:Harvey (1803–1848)" \f "Name" \b \i }.^[100] They had two daughters: Mary (1830–1918) and Martha (1839–1909).

Harvey was born in New Haven{ XE "USA, Connecticut, New Haven, New Haven:(41.3082° N, 72.9281° W):Munson, Harvey (1803–1848)" \f "Place" } on Saturday, 9th April 1803.^[100] He reached 44 years of age and died in 1848.^[100] Harvey was buried in New Haven{ XE "USA, Connecticut, New Haven, New Haven:(41.3082° N, 72.9281° W):Munson, Harvey (1803–1848)" \f "Place" }.^[100]

- m VII. **Hiram Sears**{ XE "Sears:Hiram (1811–1864)" \f "Name" \b } was born in Meredith{ XE "USA, New York, Delaware, Meredith:(42.3583° N, 74.9348° W):Sears, Hiram (1811–1864)" \f "Place" } on 25th May 1811.^[111, 112] He died in Meredith{ XE "USA, New York, Delaware, Meredith:(42.3583° N, 74.9348° W):Sears, Hiram (1811–1864)" \f "Place" } on 31st January 1864, at the age of 52.^[112] His estate was probated on 20th February 1864, in Delaware{ XE "USA, New York, Delaware:(42.2008° N, 74.9648° W):Sears, Hiram (1811–1864)" \f "Place" }.^[112]

More facts and events for Hiram Sears:

Residence: 1855 Meredith, Delaware{ XE "USA, New York, Delaware, Meredith:(42.3583° N, 74.9348° W):Sears, Hiram (1811–1864)" \f "Place" }.^[111]

Relation to Head of House: Head

Hiram Sears married **Phidelia Tuttle**{ XE "Tuttle:Phidelia (1813–1843)" \f "Name" \b \i } on Thursday, 13th November 1834. They had two children: Angeline (1836–1864) and Rufus (1838–1913).

Phidelia was born in perh, Meredith,{ XE "USA, New York, Delaware, Meredith, perh: :Tuttle, Phidelia (1813–1843)" \f "Place" } in 1813. She reached 30 years of age and died on 12th August 1843.

Hiram Sears married **Elizabeth Frisbie**{ XE "Frisbie:Elizabeth (1819–)" \f "Name" \b \i } on Friday, 26th April 1844.^[111, 113, 114] They had four children: Hiram (1850–1860), Sarah (1852–), Phidelia (1855–1925) and Millard (1860–).

Elizabeth was born in New York{ XE "USA, New York:(42.7531° N, 74.2224° W):Frisbie, Elizabeth (1819–)" \f "Place" } in 1819.^[111, 113, 114]

- m VIII. **Rufus Sears**{ XE "Sears:Rufus (1817–1842)" \f "Name" \b } was born in Meredith{ XE "USA, New York, Delaware, Meredith:(42.3583° N, 74.9348° W):Sears, Rufus (1817–1842)" \f "Place" } in 1817. He died in Bath, Steuben,{ XE "USA, New York, Steuben, Bath:(42.337° N, 77.3177° W):Sears, Rufus (1817–1842)" \f "Place" } on 7th April 1842, at the age of 25.

¹¹² Ancestry.com, New York, Wills and Probate Records, 1659-1999 (Provo, UT, USA, Ancestry.com Operations, Inc., 2015), Ancestry.com, Probate Records, 1803-1930; Author: New York. Surrogate's Court (Delaware County); Probate Place: Delaware, New York.

¹¹³ Ancestry.com, New York, State Census, 1875 (Provo, UT, USA, Ancestry.com Operations, Inc., 2013), Ancestry.com. [Source citation includes one media item]

¹¹⁴ Ancestry.com, New York, State Census, 1865 (Provo, UT, USA, Ancestry.com Operations, Inc., 2014), Ancestry.com. [Source citation includes one media item]

Family of Elizabeth Sears and Lemuel Sizer{ TC "Elizabeth Sears and Lemuel Sizer" \I 3 \f C}

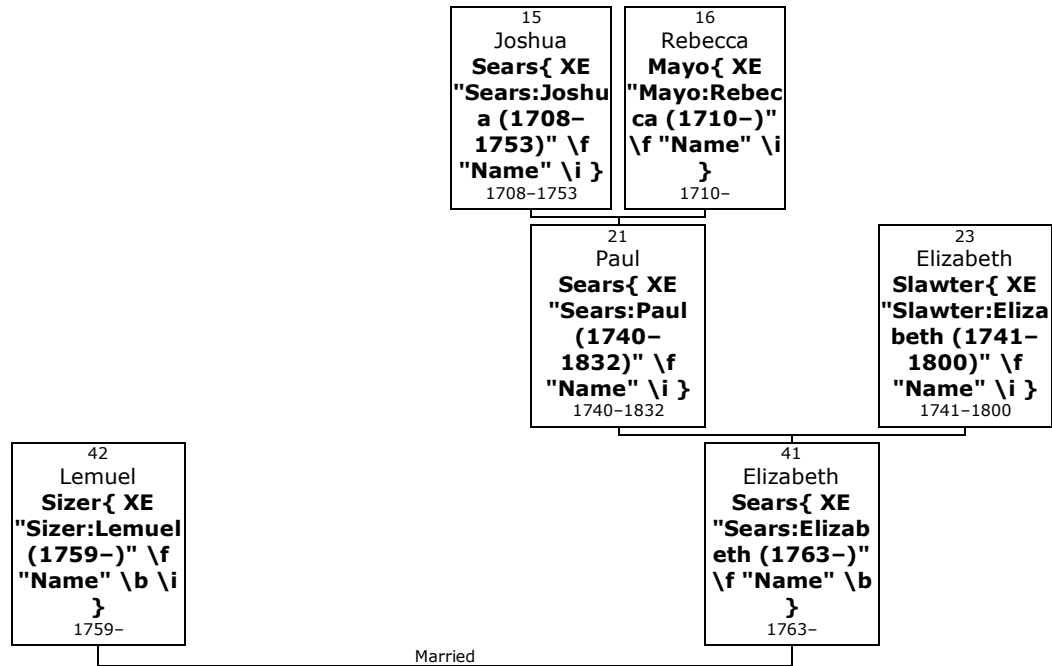

41. **Elizabeth⁴ Sears**{ XE "Sears:Elizabeth (1763-)" \f "Name" \b } (*Paul³, Joshua²*) was born on Wednesday, 16th February 1763, in Sandisfield, Berkshire, Massachusetts, USA{ XE "USA, Massachusetts, Berkshire, Sandisfield:(42.1126° N, 73.1432° W):Sears, Elizabeth (1763-)" \f "Place" }. She was the daughter of Paul Sears{ XE "Sears:Paul (1740-1832)" \f "Name" \i } (21) and Elizabeth Slawter{ XE "Slawter:Elizabeth (1741-1800)" \f "Name" \i } (23).

S P May No 540, p. 138

Susan Straw <ancestorspeak@gmail.com> Fri, Dec 20, 2019 at 2:17 PM

To: "Leslie Ray Sears, III" <lrs@sears@gmail.com>

The original spelling of my husband's Handy lineage was "Hendee" and morphed into its current spelling during the mid 1700's to early 1800's. Richard Hendee arrived in the colonies on the Hopewell in 1634 and settled in Connecticut. As far as I can tell, the Handy's of Massachusetts are not his ancestors unless they go back into England before coming to the colonies.

The children of Paul and Elizabeth Sears were all born in Sandisfield, Berkshire, Massachusetts (abbreviation Sand.), not Sandwich, Barnstable, Massachusetts. I have the birth records from the state of Massachusetts, which [I am sure] is where S.P. May got his information from.

I believe the reference to Elizabeth Sears marrying a Handy in many of the online lineages is a mistake. Someone confused Nancy Sears' marriage to a Handy with Elizabeth and the bad habit of copying lineages without vetting continues the information. As I indicated in my last email, Elizabeth Sears (of Sandisfield, MA) married Lemuel Sizer by 1791. This may have been her 2nd marriage and she may have married a Handy prior, but I don't think so. Unfortunately, I have not been able to find marriage records for either sister and am having to use secondary sources. (I see you have changed the information about Elizabeth on WikiTree 😊)

Cyrenus Handy settled in Colebrook, Connecticut with his extended family circa 1781. Property records show the land they settled was about 8 miles (current roads) to where the approximate property of Paul Sears was in Sandisfield, Massachusetts. The Sears lived along the Clam River which drains into the Farmington River. The Handys lived near the Farmington River. It isn't hard to imagine travel between the two locations may have been easier along the water route.

Nancy Handy was witness to two land transactions between her husband and (3) children in 1817. She was made administrator, along with son, Hiram, of Cyrenus' estate in 1823. The 1880 census for son James Handy, indicates that his mother was born in Massachusetts. The information on the 1800 and 1810 censuses narrows her birth to between 1766 and 1774. Given this information, I did a broad search on

FamilySearch.org starting with the Massachusetts counties that border Connecticut. Berkshire county gave two hits. Only one, Nancy Sears, was viable. The information from Samuel P May makes the connection more credible, although I would feel more confident if he had a source for his information.

I can now only hope that somewhere there is a family bible, diary, letters, etc. that would clearly show Nancy Sears married Cyrenus Handy.

Sue Straw
AncestorSpeak@gmail.com

42. She married **Lemuel Sizer**{ XE "Sizer:Lemuel (1759-)" \f "Name" \b \i }. They had no known children. Lemuel was born in perh, Sandisfield,{ XE "USA, Massachusetts, Berkshire, Sandisfield, perh: :Sizer, Lemuel (1759-)" \f "Place" } in 1759.

Family of Nancy Sears and Cyrenus Handy{ TC "Nancy Sears and Cyrenus Handy" \I 3 \f C}

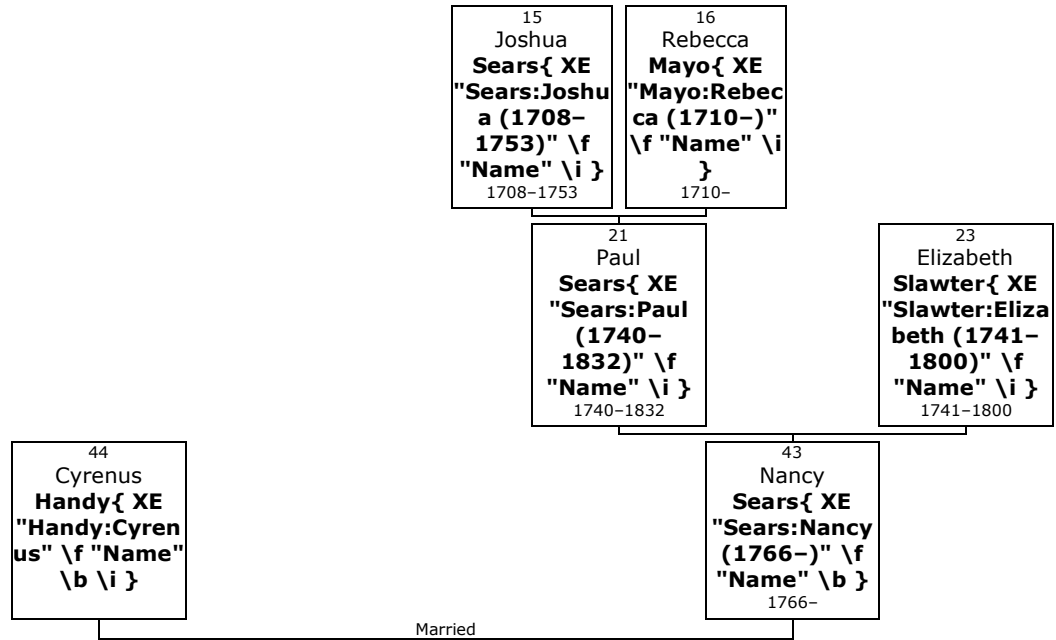

43. **Nancy⁴ Sears**{ XE "Sears:Nancy (1766-)" \f "Name" \b } (*Paul³, Joshua²*) was born on Wednesday, 12th November 1766, in Sandisfield, Berkshire, Massachusetts, USA{ XE "USA, Massachusetts, Berkshire, Sandisfield:(42.1126° N, 73.1432° W):Sears, Nancy (1766-)" \f "Place" }. She was the daughter of Paul Sears{ XE "Sears:Paul (1740-1832)" \f "Name" \i } (21) and Elizabeth Slawter{ XE "Slawter:Elizabeth (1741-1800)" \f "Name" \i } (23).

S P May No 541
<https://www.wikitree.com/wiki/Sears-4476> per Sue Straw- married Cyrenus Handy

Susan Straw <ancestorspeak@gmail.com>gt Thu, Dec 19, 2019 at 7:27 PM
To: LRSears@gmail.com
Hello,

I am researching the Handy family of Colebrook, Connecticut. I have come across your research, both on Wikitree and your published [1st edition] book. You list Elizabeth, the daughter of Paul Sears (1740-1832) and Elizabeth Slawter (-1800), as having married a Handy. My research shows Elizabeth married Lemuel Sizer (1759-1831). She was married to him by December 21, 1791, as she and her husband appeared before a justice of the peace after signing a land deed.

The book, "The Descendants of Richard Sares (Sears)", by Samuel P. Mays, gives no husband for Elizabeth, but shows her sister, Nancy Sears, married ____ Handy. Unfortunately, there is no document referenced. I believe Nancy married Cyrenus Handy (1764-1823) based on secondary documents. I am currently writing a proof argument, but would appreciate any information you might have concerning the "marriage" of Elizabeth to a Handy or have proof of a Handy marrying Nancy. Any relationship of the Sears family to the Handys would be helpful.

Thank you for your time,

Sue Straw

AncestorSpeak@gmail.com

Leslie Ray Sears, III <lrs@sears.com> Fri, Dec 20, 2019 at 12:47 AM

To: Susan Straw <ancestorspeak@gmail.com>

Hi Sue

Sorry i can't offer any more info on May. I have never been able to find his original papers so i only have his p. 138 No 540 (scanned image attached from May's personal copy- offers no other notes or source) for a source for Elizabeth of Sandwich, Barnstable co marrying a Handy. I do have the Sandwich Vital Records if you think there could be a trail there. There are a bunch of Handy's in Sandwich (index img attached) Any of them look interesting to you? The Elizabeth's listed in Sandwich index don't seem to have any connection to a Sears.

I would be very interested in anything you find.

Regards

Ray

Other Handy's in the Sears database also seem to be from Sandwich and Plymouth county. Susannah and Thankful Handy sisters who m. Sears brothers, sons of Judah Sears (1699-1776)

=====

Susannah Handy was born on 27 Sep 1746 in Sandwich, Barnstable, Massachusetts, USA as the first child of Zaccheus Handy and Susannah --Handy. She had one sibling, namely: Thankful. She died on 24 May 1783. When she was 19, she married David Sears, son of Judah Sears and Mary Paddock, on 13 Feb 1766 in Rochester, Plymouth, Massachusetts, USA.

David Sears and Susannah Handy had the following children:

Lot Sears was born on 02 Jul 1767 in Rochester, Plymouth, Massachusetts, USA. He died in Feb 1848 in Manhattan, New York, New York, USA. He married Lurany Butler on 02 Oct 1798.

Prince Sears was born on 15 Oct 1768 in Rochester, Plymouth, Massachusetts, USA. He died on 25 Oct 1797 in Taunton, Bristol, Massachusetts, USA. He married Sallie Tucker on 20 Apr 1793 in Taunton, Bristol, Massachusetts, USA. He married Rebecca Fuller on 03 Jun 1794.

Susannah Sears was born on 29 Dec 1770 in Rochester, Plymouth, Massachusetts, USA.

Alice Sears was born on 01 Sep 1773 in Rochester, Plymouth, Massachusetts, USA. She married Ebenezer Clarke on 12 Dec 1792.

Achsah Sears was born on 09 Apr 1776 in Rochester, Plymouth, Massachusetts, USA. She died on 15 Feb 1815. She married Daniel Belden Stow on 23 Oct 1796.

David Sears was born on 19 Jul 1778 in Rochester, Plymouth, Massachusetts, USA. He married Phebe Pease in Hudson, Columbia, New York, USA.

=====

Thankful Handy was born on 29 May 1752 in perh, Rochester, Plymouth, Massachusetts, USA as the second child of Zaccheus Handy and Susannah --Handy. She had one sibling, namely: Susannah. She died on 04 Mar 1818 in Rochester, Plymouth, Massachusetts, USA. When she was 17, she married Stephen Bassett on 20 Nov 1769.

Nathan Sears and Thankful Handy had the following children:

Stephen B Sears was born in 1780 in Rochester, Plymouth, Massachusetts, USA. He died on 14 Mar 1847 in Rochester, Plymouth, Massachusetts, USA. He married Azubah Mendall in Aug 1803.

Rebecca Sears was born on 20 Sep 1782 in Rochester, Plymouth, Massachusetts, USA. She died on 24 Mar 1819.

Nathan Sears was born on 27 Sep 1785 in Rochester, Plymouth, Massachusetts, USA. He died in Fairhaven, Bristol, Massachusetts, USA. He married Hannah Parker on 07 Apr 1819 in Rochester, Plymouth, Massachusetts, USA.

Sukey Sears was born on 27 Sep 1786 in Rochester, Plymouth, Massachusetts, USA. She died on 10 Dec 1857. She married Presbury Clark on 02 Jul 1820 in Rochester, Plymouth, Massachusetts, USA (by Rev Cobb).

Stephen Bassett and Thankful Handy had no children.

!She must be sister to brother-in-law David's wife.

!NEHGS vol 125, pg 249 children with Stephen b. Rochester Timothy, Lydia, Peres, Lydia

!Rochester VR SEARS Thankful, w. [dup. and second dup. Lt.] Nathan, Mar. 4, 1818, a. 65 y. 9 m. 6 d.

=====

Charles H Handy who m. Edith W Howes

=====

Moses A Handy of the Harwich bunch who d. Andersonville Prison 1 Oct 1864

=====

Susan Straw <ancestorspeak@gmail.com> Fri, Dec 20, 2019 at 2:17 PM

To: "Leslie Ray Sears, III" <rsears@gmail.com>

The original spelling of my husband's Handy lineage was "Hendee" and morphed into its current spelling during the mid 1700's to early 1800's. Richard Hendee arrived in the colonies on the Hopewell in 1634 and settled in Connecticut. As far as I can tell, the Handy's of Massachusetts are not his ancestors unless they go back into England before coming to the colonies.

The children of Paul and Elizabeth Sears were all born in Sandisfield, Berkshire, Massachusetts (abbreviation Sand.), not Sandwich, Barnstable, Massachusetts. I have the birth records from the state of Massachusetts, which [I am sure] is where S.P. May got his information from.

I believe the reference to Elizabeth Sears marrying a Handy in many of the online lineages is a mistake. Someone confused Nancy Sears' marriage to a Handy with Elizabeth and the bad habit of copying lineages without vetting continues the information. As I indicated in my last email, Elizabeth Sears (of Sandisfield, MA) married Lemuel Sizer by 1791. This may have been her 2nd marriage and she may have married a Handy prior, but I don't think so. Unfortunately, I have not been able to find marriage records for either sister and am having to use secondary sources. (I see you have changed the information about Elizabeth on WikiTree 😊)

Cyrenus Handy settled in Colebrook, Connecticut with his extended family circa 1781. Property records show the land they settled was about 8 miles (current roads) to where the approximate property of Paul Sears was in Sandisfield, Massachusetts. The Sears lived along the Clam River which drains into the Farmington River. The Handys lived near the Farmington River. It isn't hard to imagine travel between the two locations may have been easier along the water route.

Nancy Handy was witness to two land transactions between her husband and (3) children in 1817. She was made administrator, along with son, Hiram, of Cyrenus' estate in 1823. The 1880 census for son James Handy, indicates that his mother was born in Massachusetts. The information on the 1800 and 1810 censuses narrows her birth to between 1766 and 1774. Given this information, I did a broad search on FamilySearch.org starting with the Massachusetts counties that border Connecticut. Berkshire county gave two hits. Only one, Nancy Sears, was viable. The information from Samuel P May makes the connection more credible, although I would feel more confident if he had a source for his information.

I can now only hope that somewhere there is a family bible, diary, letters, etc. that would clearly show Nancy Sears married Cyrenus Handy.

Sue Straw
AncestorSpeak@gmail.com

44. She married **Cyrenus Handy**{ XE "Handy: Cyrenus" \f "Name" \b \i }.

Family of Paul Sears and Rachel Granger{ TC "Paul Sears and Rachel Granger" \I 3 \f C}

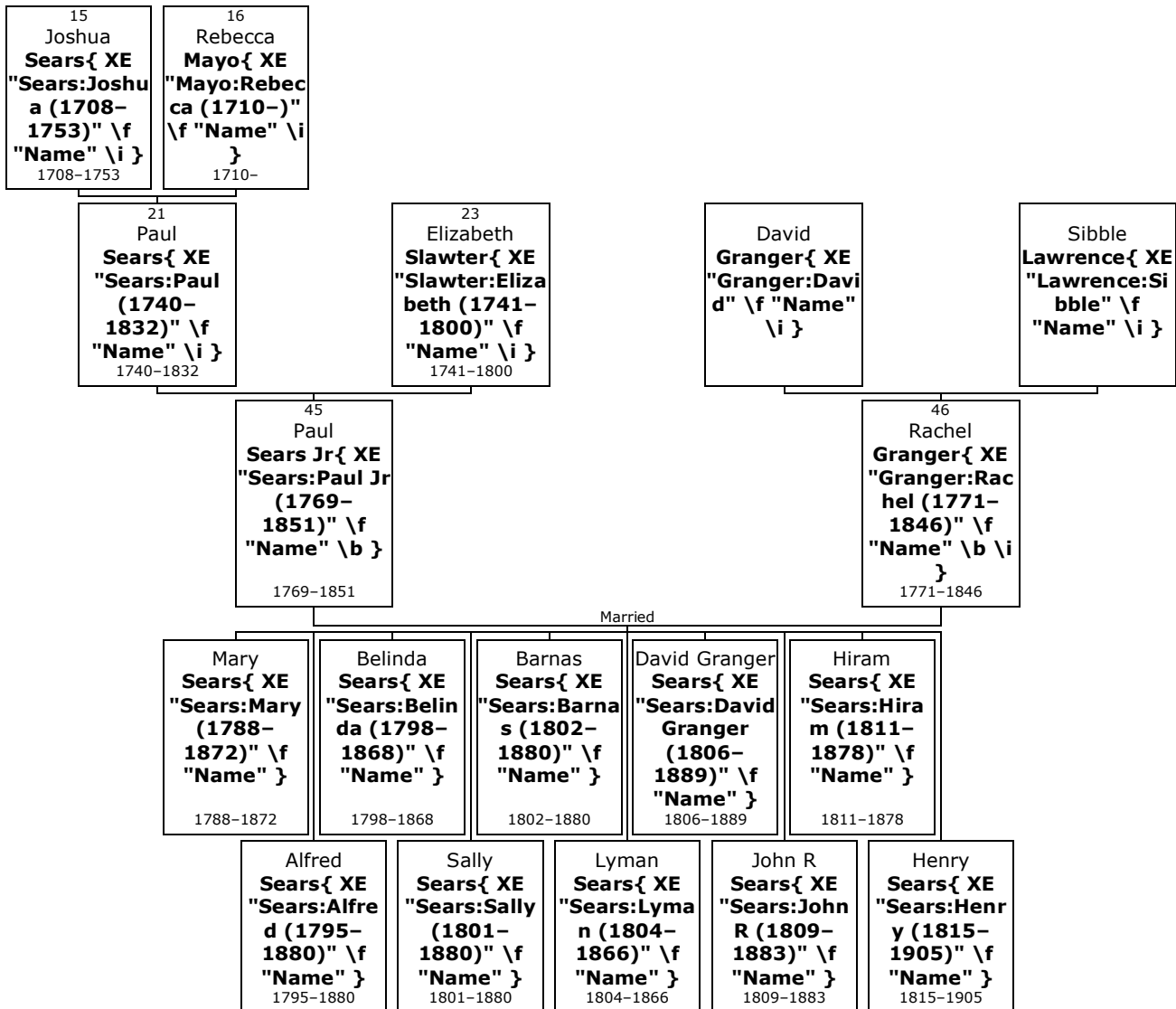

45. **Paul⁴ Sears Jr**{ XE "Sears:Paul Jr (1769-1851)" \f "Name" \b } (*Paul³, Joshua²*) was born on Thursday, 2nd February 1769, in Sandisfield, Berkshire, Massachusetts, USA{ XE "USA, Massachusetts, Berkshire, Sandisfield:(42.1126° N, 73.1432° W):Sears, Paul Jr (1769-1851)" \f "Place" }.^[115] He was the son of Paul Sears{ XE "Sears:Paul (1740-1832)" \f "Name" \i } (21) and Elizabeth Slawter{ XE "Slawter:Elizabeth (1741-1800)" \f "Name" \i } (23).

Paul died in Sandisfield, Berkshire County,{ XE "USA, Massachusetts, Berkshire County, Sandisfield:(42.1126° N, 73.1432° W):Sears, Paul Jr (1769-1851)" \f "Place" } on 25th September 1851, at the age of 82.^[115] He was buried in Sandisfield{ XE "USA, Massachusetts, Berkshire County, Sandisfield:(42.1126° N, 73.1432° W):Sears, Paul Jr (1769-1851)" \f "Place" }.^[115]

!S P May No 542 d. of consumption

Wikitree-3664

¹¹⁵ Ancestry.com, U.S., Find A Grave Index, 1600s-Current (Provo, UT, USA, Ancestry.com Operations, Inc., 2012), Ancestry.com.

More facts and events for Paul Sears Jr:

- Residence: 1790 Sandisfield, Berkshire{ XE "USA, Massachusetts, Berkshire, Sandisfield:(42.1126° N, 73.1432° W):Sears, Paul Jr (1769–1851)" \f "Place" }^[116]
- Residence: 1800 Sandisfield{ XE "USA, Massachusetts, Berkshire, Sandisfield:(42.1126° N, 73.1432° W):Sears, Paul Jr (1769–1851)" \f "Place" }^[116]
- Residence: 1810 Sandisfield{ XE "USA, Massachusetts, Berkshire, Sandisfield:(42.1126° N, 73.1432° W):Sears, Paul Jr (1769–1851)" \f "Place" }^[116]
- Residence: 1830 Sandisfield{ XE "USA, Massachusetts, Berkshire, Sandisfield:(42.1126° N, 73.1432° W):Sears, Paul Jr (1769–1851)" \f "Place" }
- Residence: 1840 Sandisfield{ XE "USA, Massachusetts, Berkshire, Sandisfield:(42.1126° N, 73.1432° W):Sears, Paul Jr (1769–1851)" \f "Place" }
- Residence: 1850 Sandisfield{ XE "USA, Massachusetts, Berkshire, Sandisfield:(42.1126° N, 73.1432° W):Sears, Paul Jr (1769–1851)" \f "Place" }

- 46.** He married **Rachel Granger**{ XE "Granger:Rachel (1771–1846)" \f "Name" \b \i }.^[115, 116] They had ten children: Mary (1788–1872), Alfred (1795–1880), Belinda (1798–1868), Sally (1801–1880), Barnas (1802–1880), Lyman (1804–1866), David (1806–1889), John (1809–1883), Hiram (1811–1878) and Henry (1815–1905).

Rachel was born in Sandisfield{ XE "USA, Massachusetts, Berkshire, Sandisfield:(42.1126° N, 73.1432° W):Granger, Rachel (1771–1846)" \f "Place" } on Sunday, 4th August 1771.^[115, 116] She was the daughter of David Granger{ XE "Granger:David" \f "Name" \i } and Sibble Lawrence{ XE "Lawrence:Sibble" \f "Name" \i }.

She was christened in Suffield, Hartford, Connecticut,{ XE "USA, Connecticut, Hartford, Suffield:(41.9817° N, 72.6511° W):Granger, Rachel (1771–1846)" \f "Place" } on 13th October 1771. Rachel reached 75 years of age and died in Sandisfield, Berkshire County,{ XE "USA, Massachusetts, Berkshire County, Sandisfield:(42.1126° N, 73.1432° W):Granger, Rachel (1771–1846)" \f "Place" } on 23rd August 1846.^[115, 116] She was buried in Sandisfield{ XE "USA, Massachusetts, Berkshire County, Sandisfield:(42.1126° N, 73.1432° W):Granger, Rachel (1771–1846)" \f "Place" }.^[115, 116]

More facts and events for Rachel Granger:

- Residence: 1800 Sandisfield, Berkshire{ XE "USA, Massachusetts, Berkshire, Sandisfield:(42.1126° N, 73.1432° W):Granger, Rachel (1771–1846)" \f "Place" }^[116]
- Residence: 1840 Sandisfield{ XE "USA, Massachusetts, Berkshire, Sandisfield:(42.1126° N, 73.1432° W):Granger, Rachel (1771–1846)" \f "Place" }^[116]

Children of Paul Sears Jr and Rachel Granger:

- f I. **Mary^s Sears**{ XE "Sears:Mary (1788–1872)" \f "Name" \b } was born in Sandisfield{ XE "USA, Massachusetts, Berkshire, Sandisfield:(42.1126° N, 73.1432° W):Sears, Mary (1788–1872)" \f "Place" } on 2nd July 1788.^[116] She died in Orange{ XE "USA, New Jersey, Essex, Orange:(40.7707° N, 74.2326° W):Sears, Mary (1788–1872)" \f "Place" } on 22nd June 1872, at the age of 83.^[116] Mary was buried in Brooklyn, Kings, New York{ XE "USA, New York, Kings, Brooklyn:(40.65° N, 73.95° W):Sears, Mary (1788–1872)" \f "Place" }.^[116]

More facts and events for Mary Sears:

- Residence: 1870 West Orange, Essex, New Jersey{ XE "USA, New Jersey, Essex, West Orange:(40.7987° N, 74.2391° W):Sears, Mary (1788–1872)" \f "Place" }^[116]

¹¹⁶ "Ancestry Family Tree", Record for Mary Sears.
<http://search.ancestry.com/cgi-bin/sse.dll?db=1030&h=34490024095&indiv=try>.

At the age of 28, Mary married **James Burt**{ XE "Burt:James (1791-1874)" \f "Name" \b \i } on Monday, 28th October 1816, when he was 25 years old.^[116] They had six children: Adelia (1822-1903), John (1825-1910), Mary (1830-1912), Edwin, James and Anna.

James was born in Granville, Hampden, Massachusetts,{ XE "USA, Massachusetts, Hampden, Granville:(42.0668° N, 72.8615° W):Burt, James (1791-1874)" \f "Place" } on Friday, 22nd July 1791.^[116] He was also known as **James Vitler**{ XE "Vitler:James (James Burt) (1791-1874)" \f "Name" }.^[116]

James reached 82 years of age and died in Kings, New York,{ XE "USA, New York, Kings:(40.6358° N, 73.9506° W):Burt, James (1791-1874)" \f "Place" } on 31st January 1874.^[116] He was buried in Brooklyn, Kings{ XE "USA, New York, Kings, Brooklyn:(40.65° N, 73.95° W):Burt, James (1791-1874)" \f "Place" }.^[116]

!SPM p.228 For many years of firm Burt, Sears & Co, Hartford, CT

- m II. **Alfred Sears**{ XE "Sears:Alfred (1795-1880)" \f "Name" \b } was born in Sandisfield{ XE "USA, Massachusetts, Berkshire, Sandisfield:(42.1126° N, 73.1432° W):Sears, Alfred (1795-1880)" \f "Place" } on 25th September 1795.^[115, 117] He died in Rockford{ XE "USA, Illinois, Winnebago, Rockford:(42.2711° N, 89.094° W):Sears, Alfred (1795-1880)" \f "Place" } on 13th October 1880, at the age of 85.^[115] Alfred was buried in Rockford, Winnebago County{ XE "USA, Illinois, Winnebago County, Rockford:(42.2711° N, 89.094° W):Sears, Alfred (1795-1880)" \f "Place" }.^[115]

More facts and events for Alfred Sears:

Residence: 1880 Rockford, Winnebago{ XE "USA, Illinois, Winnebago, Rockford:(42.2711° N, 89.094° W):Sears, Alfred (1795-1880)" \f "Place" }.^[117]

Marital status: Widower; Relation to Head of House: Father-in-law

Alfred Sears married **Eliza Daland**{ XE "Daland:Eliza (1801-1868)" \f "Name" \b \i }.^[115] They had three children: Barnas (1823-1893), Delos (1828-1888) and Mary (1831-1892).

Eliza was born in Paris, Oneida, New York,{ XE "USA, New York, Oneida, Paris:(43.0006° N, 75.3142° W):Daland, Eliza (1801-1868)" \f "Place" } in 1801.^[115] She was the daughter of Philip Deland{ XE "Deland:Philip" \f "Name" \i }.

Eliza reached 67 years of age and died in Rockford, Winnebago County, Illinois,{ XE "USA, Illinois, Winnebago County, Rockford:(42.2711° N, 89.094° W):Daland, Eliza (1801-1868)" \f "Place" } on 5th April 1868.^[115] She was buried in Rockford, Winnebago{ XE "USA, Illinois, Winnebago, Rockford:(42.2711° N, 89.094° W):Daland, Eliza (1801-1868)" \f "Place" }.^[115]

CHILD-SPOUSE: CarDel Scribe: Vol 20 No 4, p 29 Jul 83 Queries; Blaine Winslow !IGI shows Deland

- f III. **Belinda Sears**{ XE "Sears:Belinda (1798-1868)" \f "Name" \b } was born in Sandisfield{ XE "USA, Massachusetts, Berkshire, Sandisfield:(42.1126° N, 73.1432° W):Sears, Belinda (1798-1868)" \f "Place" } on 23rd August 1798.^[118] She died on 30th November 1868, at the age of 70.

More facts and events for Belinda Sears:

Residence: 1860 Youngstown{ XE "USA, Ohio, Mahoning, Youngstown:(41.1009° N, 80.64° W):Sears, Belinda (1798-1868)" \f "Place" }.^[118]
Age: 59; RealEstateValue: 2000

¹¹⁷ Ancestry.com and The Church of Jesus Christ of Latter-day Saints, 1880 United States Federal Census (Provo, UT, USA, Ancestry.com Operations Inc, 2010), Ancestry.com, Year: 1880; Census Place: Rockford, Winnebago, Illinois; Roll: 261; Family History Film: 1254261; Page: 158D; Enumeration District: 228; Image: 0627.

¹¹⁸ Ancestry.com, 1860 United States Federal Census (Provo, UT, USA, Ancestry.com Operations, Inc., 2009), Ancestry.com, Year: 1860; Census Place: Youngstown, Mahoning, Ohio; Roll: M653_1005; Page: 78; Family History Library Film: 805005. Record for Belinda Truesdale. <http://search.ancestry.com/cgi-bin/sse.dll?db=7667&h=41688831&indiv=try>.

Belinda Sears married **Luman Davis**{ XE "Davis:Luman" \f "Name" \b \i } about 1819. They had one daughter: Mary.

Belinda married **Anson Avery**{ XE "Avery:Anson" \f "Name" \b \i }.

Belinda married **Robinson Truesdale**{ XE "Truesdale:Robinson (1801-1867)" \f "Name" \b \i } about 1855. They had no known children.

Robinson was born in Washington, Pennsylvania,{ XE "USA, Pennsylvania, Washington:(40.1888° N, 80.2478° W):Truesdale, Robinson (1801-1867)" \f "Place" } in 1801. He reached 66 years of age and died in Youngstown, Mahoning, Ohio,{ XE "USA, Ohio, Mahoning, Youngstown:(41.1009° N, 80.64° W):Truesdale, Robinson (1801-1867)" \f "Place" } on 26th August 1867.

- f IV. **Sally Sears**{ XE "Sears:Sally (1801-1880)" \f "Name" \b } was born in Sandisfield{ XE "USA, Massachusetts, Berkshire, Sandisfield:(42.1126° N, 73.1432° W):Sears, Sally (1801-1880)" \f "Place" } on 1st July 1801.^[119, 120, 121, 122-123] She died in November 1880 at the age of 79.^[119, 123]

More facts and events for Sally Sears:

Residence: 1880 Fountain{ XE "USA, Minnesota, Fillmore, Fountain:(43.74° N, 92.1363° W):Sears, Sally (1801-1880)" \f "Place" }^[119, 123]

At the age of 19, Sally Sears married **William Bolles**{ XE "Bolles:William (1798-1880)" \f "Name" \b \i } on Wednesday, 15th November 1820, when he was 22 years old. They had six children: Jason (1825-), Jane (1830-1912), Clarinda (1830-1870), Ensign (1834-1917), Sarah (1834-) and William (1842-1910).

William was born in New Bedford, Bristol, Massachusetts,{ XE "USA, Massachusetts, Bristol, New Bedford:(41.6362° N, 70.9342° W):Bolles, William (1798-1880)" \f "Place" } on Wednesday, 28th February 1798. He reached 82 years of age and died in November 1880. William was buried in Winslow Cemetery{ XE "USA, Minnesota, Fillmore, Winslow Cemetery: :Bolles, William (1798-1880)" \f "Place" }.

!SPM p.229 rem. to central NY where he engaged in manuf scythes; was foreman of E Remington & Sons works for many years, now lives in Fountain, MN

- m V. **Barnas Sears**{ XE "Sears:Barnas (1802-1880)" \f "Name" \b } was born in Sandisfield{ XE "USA, Massachusetts, Berkshire, Sandisfield:(42.1126° N, 73.1432° W):Sears, Barnas (1802-1880)" \f "Place" } on 19th November 1802.^[115, 124] He was known by the title of Rev.

¹¹⁹ FamilySearch.org, FamilySearch Family Tree, FamilySearch, "Family Tree," database, <i>FamilySearch</i> (http://familysearch.org : modified 22 June 2018, 04:03), entry for Sally Sears(PID https://familysearch.org/ark:/61903/4:1:LCFK-S4J); contributed by various users. PersonID LCFK-S4J. Sally Sears. https://familysearch.org/ark:/61903/4:1:LCFK-S4J.

¹²⁰ FamilySearch.org, FamilySearch Family Tree, FamilySearch, "Minnesota Deaths and Burials, 1835-1990," database, <i>FamilySearch</i> (https://familysearch.org/ark:/61903/1:1:FD48-2B1 : 10 February 2018), Sarah Sears in entry for Jane Elisa Bolles, 09 Dec 1912; citing Chatfield, Fillmore, Minnesota, reference P 89. Sarah Sears in entry for Jane Elisa Bolles, "Minnesota Deaths and Burials, 1835-1990". https://familysearch.org/ark:/61903/1:1:FD48-2B1.

¹²¹ FamilySearch.org, FamilySearch Family Tree, FamilySearch, "Massachusetts, Town Clerk, Vital and Town Records, 1626-2001," database with images, <i>FamilySearch</i> (https://familysearch.org/ark:/61903/1:1:Q29L-DC23 : 10 February 2018), Sally Sears, 08 Jul 1801; citing Birth, Sandisfield, Berkshire, Massachusetts. Sally Sears, "Massachusetts, Town Clerk, Vital and Town Records, 1626-2001". https://familysearch.org/ark:/61903/1:1:Q29L-DC23.

¹²² FamilySearch.org, FamilySearch Family Tree, FamilySearch, "United States Census, 1880," database with images, <i>FamilySearch</i> (https://familysearch.org/ark:/61903/1:1:MZ97-FZN : 26 August 2017), Sarah Bolles in household of Wm Bolles, Fountain, Fillmore, Minnesota, United States; citing enumeration district. Sarah Bolles in household of Wm Bolles, "United States Census, 1880". https://familysearch.org/ark:/61903/1:1:MZ97-FZN.

¹²³ FamilySearch.org, FamilySearch Family Tree, FamilySearch, "Massachusetts Births and Christenings, 1639-1915," database, <i>FamilySearch</i> (https://familysearch.org/ark:/61903/1:1:VQ6D-DBP : 10 February 2018), Sally Sears, 01 Jul 1801; citing SANDISFIELD,BERKSHIRE,MASSACHUSETTS, ; FHL microfilm 250,322. Sally Sears, "Massachusetts Births and Christenings, 1639-1915". https://familysearch.org/ark:/61903/1:1:VQ6D-DBP.

¹²⁴ Ancestry.com, Massachusetts, Marriage Records, 1840-1915 (Provo, UT, USA, Ancestry.com Operations, Inc., 2013), Ancestry.com, New England Historic Genealogical Society; Boston, Massachusetts; Massachusetts Vital Records, 1911-1915.

Barnas died in Saratoga, New York, { XE "USA, New York, Saratoga:(43.1059° N, 73.8677° W):Sears, Barnas (1802-1880)" \f "Place" } on 6th July 1880, at the age of 77.^[115] He was buried in Brookline, Norfolk, Massachusetts { XE "USA, Massachusetts, Norfolk, Brookline:(42.3318° N, 71.1211° W):Sears, Barnas (1802-1880)" \f "Place" }.^[115]

At the age of 27, Rev Barnas Sears married **Elizabeth Griggs Corey** { XE "Corey:Elizabeth Griggs (1809-1883)" \f "Name" \b \i } on Tuesday, 16th February 1830, in Cambridge, Middlesex, { XE "USA, Massachusetts, Middlesex, Cambridge:(42.3751° N, 71.1056° W):Sears, Barnas (1802-1880)" \f "Place" } when she was 20 years old.^[115, 124] They had five children: William (1832-1917), Elizabeth (1838-1900), Edward (1840-1886), Robert (1842-1904) and Edward (1852-1882).

Elizabeth Griggs was born in Brookline, Norfolk, { XE "USA, Massachusetts, Norfolk, Brookline:(42.3318° N, 71.1211° W):Corey, Elizabeth Griggs (1809-1883)" \f "Place" } on Tuesday, 21st November 1809.^[115] She was the daughter of Timothy Corey { XE "Corey:Timothy (1783-)" \f "Name" \i } and Elizabeth Griggs { XE "Griggs:Elizabeth (1787-)" \f "Name" \i }.

Elizabeth Griggs reached 73 years of age and died in Staunton, Augusta, Virginia, { XE "USA, Virginia, Augusta, Staunton:(38.1496° N, 79.0717° W):Corey, Elizabeth Griggs (1809-1883)" \f "Place" } on 23rd March 1883.^[115] She was buried in Brookline, Norfolk, Massachusetts { XE "USA, Massachusetts, Norfolk, Brookline:(42.3318° N, 71.1211° W):Corey, Elizabeth Griggs (1809-1883)" \f "Place" }.^[115]

- m VI. **Lyman Sears** { XE "Sears:Lyman (1804-1866)" \f "Name" \b } was born in Sandisfield { XE "USA, Massachusetts, Berkshire, Sandisfield:(42.1126° N, 73.1432° W):Sears, Lyman (1804-1866)" \f "Place" } on 19th September 1804.^[115, 125] He died in Brooklyn { XE "USA, New York, Kings, Brooklyn:(40.65° N, 73.95° W):Sears, Lyman (1804-1866)" \f "Place" } on 10th April 1866, at the age of 61.^[115] Lyman was buried in Brooklyn { XE "USA, New York, Kings, Brooklyn:(40.65° N, 73.95° W):Sears, Lyman (1804-1866)" \f "Place" }.^[115]

More facts and events for Lyman Sears:

Residence: 1850 Ward 6, Brooklyn { XE "USA, New York, Kings, Brooklyn, Ward 6: :Sears, Lyman (1804-1866)" \f "Place" }

Residence: 1865 Brooklyn { XE "USA, New York, Kings, Brooklyn:(40.65° N, 73.95° W):Sears, Lyman (1804-1866)" \f "Place" }

Lyman Sears married **Samantha Hubbard** { XE "Hubbard:Samantha (1803-)" \f "Name" \b \i }. They had two children: Ellen (1836-1848) and Edward (1847-).

Samantha was born in Simsbury, Hartford, Connecticut, { XE "USA, Connecticut, Hartford, Simsbury:(41.8758° N, 72.8017° W):Hubbard, Samantha (1803-)" \f "Place" } on Monday, 2nd May 1803. She was buried in green-wood cemetery { XE "USA, New York, Kings, Brooklyn, green-wood cemetery: :Hubbard, Samantha (1803-)" \f "Place" } on 1st December 1857.

- m VII. **David Granger Sears** { XE "Sears:David Granger (1806-1889)" \f "Name" \b } was born in Sandisfield { XE "USA, Massachusetts, Berkshire, Sandisfield:(42.1126° N, 73.1432° W):Sears, David Granger (1806-1889)" \f "Place" } on 29th June 1806.^[125, 126, 127, 128, 129, 130-131] He died in Illinois { XE "USA, Illinois:(39.7333° N, 88.5° W):Sears, David Granger (1806-1889)" \f "Place" } on 15th March 1889, at the age of 82.^[130]



David

¹²⁵ Ancestry.com, Massachusetts, Town and Vital Records, 1620-1988 (Provo, UT, USA, Ancestry.com Operations, Inc., 2011), Ancestry.com.

¹²⁶ Ancestry.com, 1850 United States Federal Census (Provo, UT, USA, Ancestry.com Operations, Inc., 2009), Ancestry.com, Year: 1850; Census Place: Jersey, Hudson, New Jersey; Roll: M432_452; Page: 374A; Image: 400.

¹²⁷ Ancestry.com and The Church of Jesus Christ of Latter-day Saints, 1880 United States Federal Census (Provo, UT, USA, Ancestry.com Operations Inc, 2010), Ancestry.com, Year: 1880; Census Place: Rockford, Winnebago, Illinois; Roll: 261; Family History Film: 1254261; Page: 163B; Enumeration District: 228; Image: 0637.

More facts and events for David Granger Sears:

- Residence: 1830 Sandisfield, Berkshire, Massachusetts{ XE "USA, Massachusetts, Berkshire, Sandisfield:(42.1126° N, 73.1432° W):Sears, David Granger (1806–1889)" \f "Place" }^[131]
- Residence: 1850 Jersey City, Hudson, New Jersey{ XE "USA, New Jersey, Hudson, Jersey City:(40.7282° N, 74.0777° W):Sears, David Granger (1806–1889)" \f "Place" }^[126]
- Residence: 1870 Ward 2, Rockford, Winnebago, Illinois{ XE "USA, Illinois, Winnebago, Rockford, Ward 2: :Sears, David Granger (1806–1889)" \f "Place" }^[129]
- Residence: 1880 Rockford{ XE "USA, Illinois, Winnebago, Rockford:(42.2711° N, 89.094° W):Sears, David Granger (1806–1889)" \f "Place" }^[127]
 Marital Status: Married; Relation to Head of House: Self

At the age of 21, David Granger Sears married **Olive Deming**{ XE "Deming:Olive (1806–1888)" \f "Name" \b \i } on Wednesday, 20th February 1828, in Sandisfield, Berkshire, Massachusetts,{ XE "USA, Massachusetts, Berkshire, Sandisfield:(42.1126° N, 73.1432° W):Sears, David Granger (1806–1889)" \f "Place" } when she was 21 years old.^[127] They had five children: Edwin (1829–1860), Rolin (1832–1840), Mary (1834–1912), Henry (1836–) and George (1839–1866).

Olive was born in Sandisfield{ XE "USA, Massachusetts, Berkshire, Sandisfield:(42.1126° N, 73.1432° W):Deming, Olive (1806–1888)" \f "Place" } on Sunday, 12th October 1806.^[127] She reached 81 years of age and died on 16th June 1888.

- m VIII. **John R Sears**{ XE "Sears:John R (1809–1883)" \f "Name" \b } was born in Sandisfield{ XE "USA, Massachusetts, Berkshire, Sandisfield:(42.1126° N, 73.1432° W):Sears, John R (1809–1883)" \f "Place" } on 11th January 1809.^[115, 125] He died in Poughkeepsie, Dutchess, New York,{ XE "USA, New York, Dutchess, Poughkeepsie:(41.7004° N, 73.921° W):Sears, John R (1809–1883)" \f "Place" } on 24th November 1883, at the age of 74.^[115] John R was buried in Poughkeepsie, Dutchess County{ XE "USA, New York, Dutchess County, Poughkeepsie:(41.7004° N, 73.921° W):Sears, John R (1809–1883)" \f "Place" }.^[115]

John R Sears married **Esther Hyde**{ XE "Hyde:Esther (1813–)" \f "Name" \b \i }. They had one son: James (1835–).

Esther was born in New Marlborough, Berkshire, Massachusetts,{ XE "USA, Massachusetts, Berkshire, New Marlborough:(42.1229° N, 73.2287° W):Hyde, Esther (1813–)" \f "Place" } in 1813. She died in Leavenworth, Kansas{ XE "USA, Kansas, Leavenworth:(39.2024° N, 95.0381° W):Hyde, Esther (1813–)" \f "Place" }.

John R Sears married **Louisa Hyde**{ XE "Hyde:Louisa (1813–)" \f "Name" \b \i } in Great Barrington, Berkshire, Massachusetts{ XE "USA, Massachusetts, Berkshire, Great Barrington:(42.1959° N, 73.362° W):Sears, John R (1809–1883)" \f "Place" }. They had one daughter: Jane (1835–).

Louisa was born in perh, Great Barrington,{ XE "USA, Massachusetts, Berkshire, Great Barrington, perh: :Hyde, Louisa (1813–)" \f "Place" } in 1813.

¹²⁸ Godfrey Memorial Library, comp., American Genealogical-Biographical Index (AGBI) (Provo, UT, USA, Ancestry.com Operations Inc, 1999), Ancestry.com.

¹²⁹ Ancestry.com, 1870 United States Federal Census (Provo, UT, USA, Ancestry.com Operations, Inc., 2009), Ancestry.com, Year: 1870; Census Place: Rockford Ward 2, Winnebago, Illinois; Roll: M593_294; Page: 82B; Image: 457; Family History Library Film: 545793.

¹³⁰ Ancestry.com, Winnebago County, Illinois, Deaths, 1844-1992 (Provo, UT, USA, Ancestry.com Operations, Inc., 2013), Ancestry.com.

¹³¹ Ancestry.com, 1830 United States Federal Census (Provo, UT, USA, Ancestry.com Operations, Inc., 2010), Ancestry.com, 1830; Census Place: Sandisfield, Berkshire, Massachusetts; Series: M19; Roll: 62; Page: 297; Family History Library Film: 0337920.

- m IX. **Hiram Sears**{ XE "Sears:Hiram (1811–1878)" \f "Name" \b } was born in Sandisfield{ XE "USA, Massachusetts, Berkshire, Sandisfield:(42.1126° N, 73.1432° W):Sears, Hiram (1811–1878)" \f "Place" } on 8th July 1811.^[115, 132] He died in Vail, Crawford, Iowa,{ XE "USA, Iowa, Crawford, Vail:(42.0619° N, 95.2° W):Sears, Hiram (1811–1878)" \f "Place" } in September 1878 at the age of 67.^[115] Hiram was buried in Vail, Crawford County{ XE "USA, Iowa, Crawford County, Vail:(42.0619° N, 95.2° W):Sears, Hiram (1811–1878)" \f "Place" }.^[115]

At the age of 27, Hiram Sears married **Julia Louisa Pickett**{ XE "Pickett:Julia Louisa (1818–1885)" \f "Name" \b \i } on Wednesday, 26th September 1838, in Brooklyn, Kings, New York,{ XE "USA, New York, Kings, Brooklyn:(40.65° N, 73.95° W):Sears, Hiram (1811–1878)" \f "Place" } when she was 20 years old.^[115, 132, 133] They had two children: Samuel (1839–1864) and Lucia (1841–1912).

Julia Louisa was born in Sandisfield, Berkshire, Massachusetts,{ XE "USA, Massachusetts, Berkshire, Sandisfield:(42.1126° N, 73.1432° W):Pickett, Julia Louisa (1818–1885)" \f "Place" } on Saturday, 5th September 1818.^[115, 133] She was the daughter of Samuel Pickett{ XE "Pickett:Samuel" \f "Name" \i } and Louisa L Twining{ XE "Twining:Louisa L" \f "Name" \i }.

Julia Louisa reached 66 years of age and died in Vail, Crawford County,{ XE "USA, Iowa, Crawford County, Vail:(42.0619° N, 95.2° W):Pickett, Julia Louisa (1818–1885)" \f "Place" } on 20th July 1885.^[115] She was buried in Vail{ XE "USA, Iowa, Crawford County, Vail:(42.0619° N, 95.2° W):Pickett, Julia Louisa (1818–1885)" \f "Place" }.^[115]

<http://trees.ancestry.com/owt/person.aspx?pid=16848698>

- m X. **Henry Sears**{ XE "Sears:Henry (1815–1905)" \f "Name" \b } was born in Sandisfield{ XE "USA, Massachusetts, Berkshire, Sandisfield:(42.1126° N, 73.1432° W):Sears, Henry (1815–1905)" \f "Place" } on 3rd August 1815.^[115] He died on 17th October 1905, at the age of 90.^[115] Henry was buried in San Jose, Santa Clara County, California{ XE "USA, California, Santa Clara County, San Jose:(37.3394° N, 121.8949° W):Sears, Henry (1815–1905)" \f "Place" }.^[115]

At the age of 24, Henry Sears married **Lucretia Tyler Brewster**{ XE "Brewster:Lucretia Tyler (1811–1854)" \f "Name" \b \i } on Tuesday, 10th September 1839, in Norwich, New London, Connecticut,{ XE "USA, Connecticut, New London, Norwich:(41.5243° N, 72.0759° W):Sears, Henry (1815–1905)" \f "Place" } when she was 28 years old.^[134] They had two children: Frances (1841–) and Edmund (1845–1894).

Lucretia Tyler was born in Preston City{ XE "USA, Connecticut, New London, Preston City:(41.5201° N, 72.0059° W):Brewster, Lucretia Tyler (1811–1854)" \f "Place" } on Saturday, 27th July 1811.^[134] She was the daughter of Erastus Brewster{ XE "Brewster:Erastus (1775–1832)" \f "Name" \i } and Esther Hillard{ XE "Hillard:Esther (-1826)" \f "Name" \i }.

Lucretia Tyler reached 43 years of age and died in Rockford, Winnebago, Illinois,{ XE "USA, Illinois, Winnebago, Rockford:(42.2711° N, 89.094° W):Brewster, Lucretia Tyler (1811–1854)" \f "Place" } on 3rd September 1854.

changed from Lucia, p. 385, typescript Hauske Family Tree
<http://trees.ancestry.com/tree/5170623/family/pedigree> Added by phauske
Name Lucretia Tyler Brewster Conflicting Birth 8 Jul 1809 in Preston City, New London, Connecticut, USA Conflicting Death 3 Sep 1853 in Preston City, New London, Connecticut, USA Conflicting Relatives Erastus Brewster Father Esther Hillard Mother

¹³² Dodd, Jordan, Liahona Research, comp, Massachusetts, Marriages, 1633-1850 (Provo, UT, USA, Ancestry.com Operations Inc, 2005), Ancestry.com.

¹³³ Ancestry.com and The Church of Jesus Christ of Latter-day Saints, 1880 United States Federal Census (Provo, UT, USA, Ancestry.com Operations Inc, 2010), Ancestry.com, Year: 1880; Census Place: Vail, Crawford, Iowa; Roll: 335; Family History Film: 1254335; Page: 62B; Enumeration District: 066; Image: 0127.
[Source citation includes one media item]

¹³⁴ Ancestry.com, North America, Family Histories, 1500-2000 (Provo, UT, USA, Ancestry.com Operations, Inc., 2016), Ancestry.com, Book Title: The Brewster Genealogy : 1566-1907 : A record of the descendants of William Brewster of the "Mayflower," ruling Elder of the Pilgrim Church which founded Plymouth Colony in 1620: Volume 1.
[Source citation includes one media item]

At the age of 40, Henry Sears married **Mrs Esther Brewster**{ XE "Brewster:Esther (1818-1900)" \f "Name" \b \i } on Thursday, 20th September 1855, in Norwich, New London, Connecticut,{ XE "USA, Connecticut, New London, Norwich:(41.5243° N, 72.0759° W):Sears, Henry (1815-1905)" \f "Place" } when she was 37 years old.^[115, 135] They had one daughter: Maria (1856-).

Esther was born on Sunday, 25th January 1818.^[115, 135] Preston. She was the daughter of Erastus Brewster{ XE "Brewster:Erastus (1775-1832)" \f "Name" \i } and Esther Hillard{ XE "Hillard:Esther (-1826)" \f "Name" \i }.

Esther reached 82 years of age and died on 16th May 1900.^[115] She was buried in San Jose, Santa Clara County, California{ XE "USA, California, Santa Clara County, San Jose:(37.3394° N, 121.8949° W):Brewster, Esther (1818-1900)" \f "Place" }.^[115]

1870 Census shows b. CT

Simeon Sears{ TC "Simeon Sears" \I 3 \f C }

- 47. Dea. Simeon⁴ Sears**{ XE "Sears:Simeon (1776-1863)" \f "Name" \b } (*Paul³, Joshua²*) was born on Monday, 7th October 1776, in Sandisfield, Berkshire, Massachusetts, USA{ XE "USA, Massachusetts, Berkshire, Sandisfield:(42.1126° N, 73.1432° W):Sears, Simeon (1776-1863)" \f "Place" }.^[136, 137-138] He was the son of Paul Sears{ XE "Sears:Paul (1740-1832)" \f "Name" \i } (21) and Elizabeth Slawter{ XE "Slawter:Elizabeth (1741-1800)" \f "Name" \i } (23).

Simeon died in Pennsylvania{ XE "USA, Pennsylvania:(40.8583° N, 76.3834° W):Sears, Simeon (1776-1863)" \f "Place" } on 23rd December 1863, at the age of 87.^[136] He was buried in Purchase Line, Indiana, Pennsylvania{ XE "USA, Pennsylvania, Indiana, Purchase Line: :Sears, Simeon (1776-1863)" \f "Place" }.^[136]

!S P May p.231, No 544 Simeon Sears was a farmer in Sandisfield, MA, a deacon of the Baptist Ch., and a very exemplary Christian man.

!

!http://trees.ancestry.com/owt/person.aspx?pid=46808370&st=1

https://www.wikitree.com/wiki/Sears-2178

!

!1860 United States Federal Census <http://www.ancestry.com/search/db.aspx?dbid=7667> Name: Simeon Sears Age in 1860: 83 Birth Year: abt 1777 Birthplace: Massachusetts Home in 1860: Green, Indiana, Pennsylvania Gender: Male Post Office: Cookport Household Members: Name Age Julius Sears 53 Mary A Sears 49 Mary S Simons 27 William A Simons 29 Edward J Sears 24 Lucinda B Sears 18 Milan Sears 15 Simeon Sears 83 Henry S Simons 5 Sarah Simons 3 Albert Simons 5/12

!

U.S. and International Marriage Records, 1560-1900

<http://www.ancestry.com/search/db.aspx?dbid=7836> Name: Simeon Sears Gender: male Birth Place: MA Birth Year: 1776 Spouse Name: Louisa Spencer Marriage Year: 1801 Marriage State: CT Comments: Deacon Number Pages: 1

Marriages with Mary Polly [Tryphena] Hurlburt and Louisa Spencer (Page 93) are known.

¹³⁵ Ancestry.com, Connecticut Town Birth Records, pre-1870 (Barbour Collection) (Provo, UT, USA, Ancestry.com Operations Inc, 2006), Ancestry.com.

[Source citation includes one media item]

¹³⁶ Ancestry.com, U.S., Find A Grave Index, 1600s-Current (Provo, UT, USA, Ancestry.com Operations, Inc., 2012), Ancestry.com.

¹³⁷ Ancestry.com, Massachusetts, Town and Vital Records, 1620-1988 (Provo, UT, USA, Ancestry.com Operations, Inc., 2011), Ancestry.com.

[Source citation includes one media item]

¹³⁸ Ancestry.com, Early Connecticut Marriages (Provo, UT, USA, Ancestry.com Operations, Inc., 2012), Ancestry.com.

[Source citation includes one media item]

Family of Simeon Sears and Polly Hurlburt{ TC "Simeon Sears and Polly Hurlburt" \l 4 \f C}

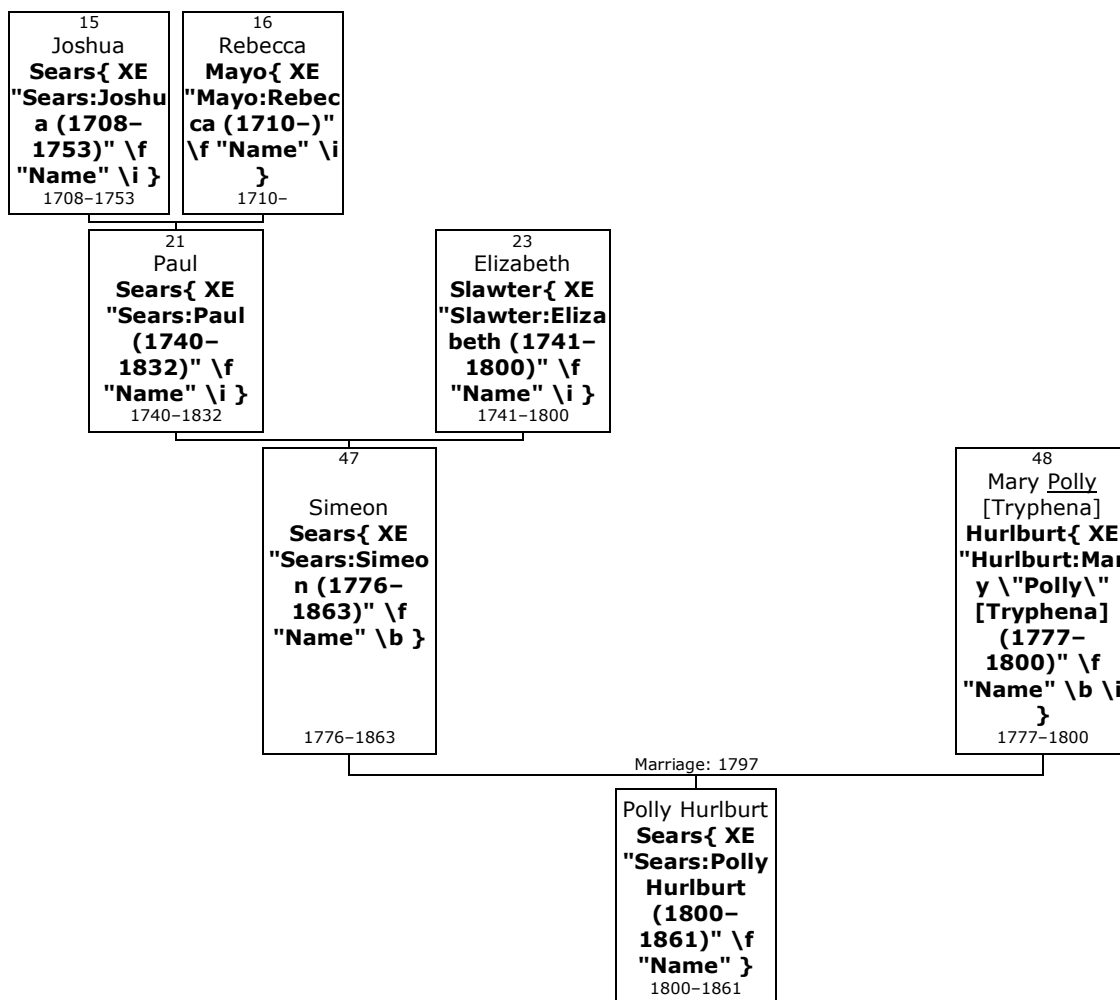

Here are the details about **Simeon Sears**{ XE "Sears:Simeon (1776-1863)" \f "Name" \b } first marriage, with Mary Polly [Tryphena] Hurlburt. You can read more about Simeon on page 91.

48. Dea. Simeon Sears married **Mary Polly [Tryphena] Hurlburt**{ XE "Hurlburt:Mary \"Polly\" [Tryphena] (1777-1800)" \f "Name" \b \i } on Thursday, 2nd November 1797, in Enfield, Hartford, Connecticut{ XE "USA, Connecticut, Hartford, Enfield:(41.9761° N, 72.5922° W):Sears, Simeon (1776-1863)" \f "Place" \i }.^[138] They had one daughter: Polly (1800-1861).

Polly was born in perh, Sandisfield, Berkshire, Massachusetts,{ XE "USA, Massachusetts, Berkshire, Sandisfield, perh: :Hurlburt, Mary \"Polly\" [Tryphena] (1777-1800)" \f "Place" \i } in 1777. She reached 23 years of age and died in Sandisfield{ XE "USA, Massachusetts, Berkshire, Sandisfield:(42.1126° N, 73.1432° W):Hurlburt, Mary \"Polly\" [Tryphena] (1777-1800)" \f "Place" \i } on 22nd December 1800.

!originally listed as Tryphena

http://search.ancestry.com/cgi-bin/sse.dll?db=ctvitalsbarbour&h=201846&ti=0&indiv=try&gss=pt&ssrc=gr_t4266398_p-1629065089_ktidz0q3d4266398z0q26pidz0q3d-1629065089z0q26hidz0q3d4244302047z0q26dbidz0q3d1034z0q26rpiz0q3d201846z0q26ssrcz0q3dgrz0q26pgz0q3d32782z0q26pgPlz0q3dtidz0q257cpidz0q257chidz0q257cbidz0q257crpidz0q257cssrcz0q26pgPSz0q3d-1629065089_h4244302047

Daughter of Simeon Sears and Mary Polly [Tryphena] Hurlburt:

- f I. **Polly Hurlburt**⁵ Sears{ XE "Sears:Polly Hurlburt (1800-1861)" \f "Name" \b } was born in Sandisfield, Berkshire, Massachusetts,{ XE "USA, Massachusetts, Berkshire, Sandisfield:(42.1126° N, 73.1432° W):Sears, Polly Hurlburt (1800-1861)" \f "Place" \i } on 23rd November 1800. She died in Virginia{ XE "USA, Virginia:(38.0667° N, 78.5833° W):Sears, Polly Hurlburt (1800-1861)" \f "Place" \i } on 22nd December 1861, at the age of 61.

Polly Hurlburt married **Benjamin Heath**{ XE "Heath:Benjamin (1796-)" \f "Name" \b \i } in 1822. They had no known children.

Benjamin was born in perh, Sandisfield, Berkshire, Massachusetts,{ XE "USA, Massachusetts, Berkshire, Sandisfield, perh: :Heath, Benjamin (1796-)" \f "Place" } in 1796.

Family of Simeon Sears and Louisa Spencer{ TC "Simeon Sears and Louisa Spencer" \I 4 \f C}

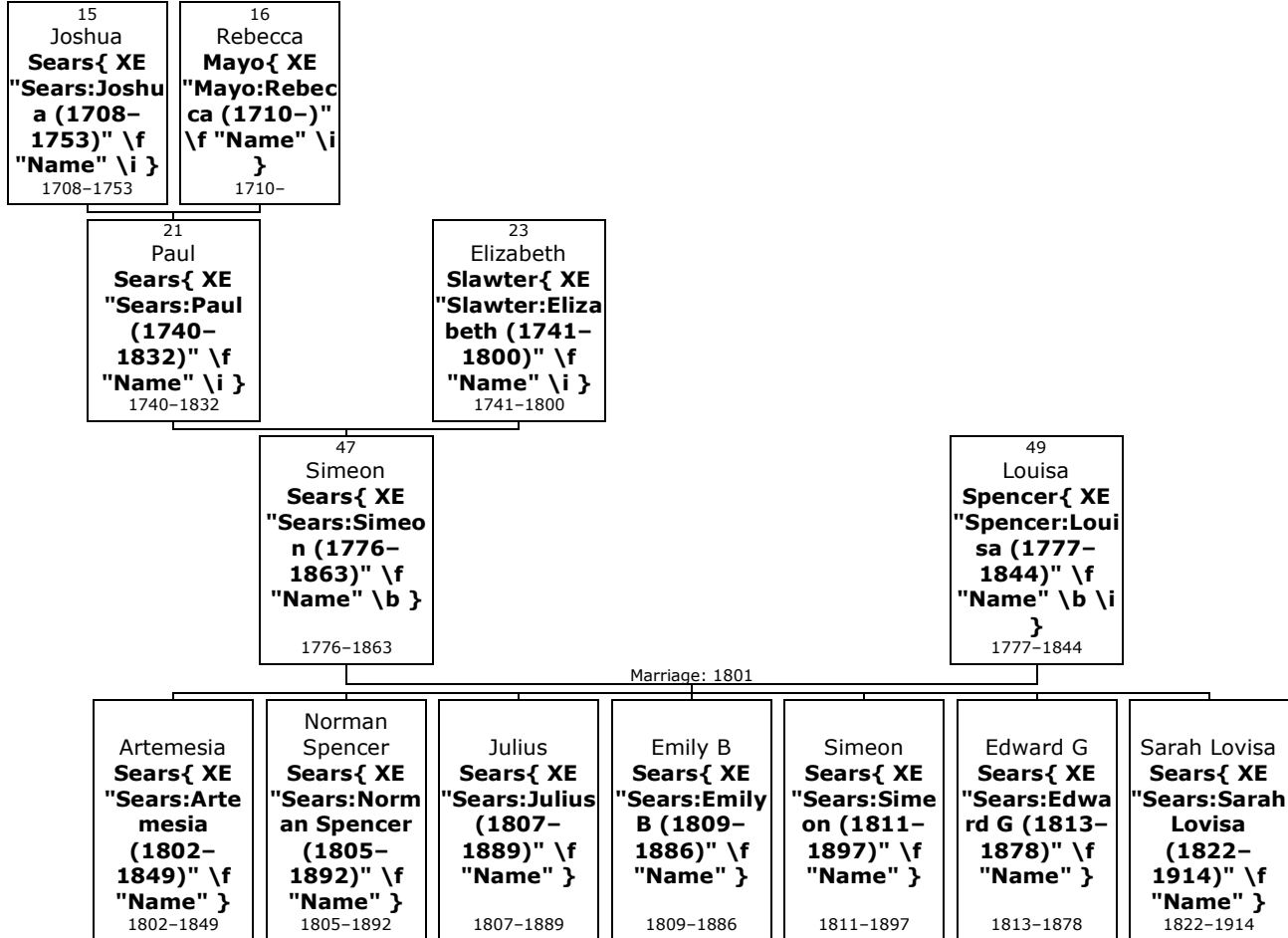

Here are the details about **Simeon Sears**{ XE "Sears:Simeon (1776-1863)" \f "Name" \b } second marriage, with Louisa Spencer. You can read more about Simeon on page 91.

49. Dea. Simeon Sears married **Louisa Spencer**{ XE "Spencer:Louisa (1777-1844)" \f "Name" \b \i } in 1801 in East Hartford, Hartford, Connecticut,{ XE "USA, Connecticut, Hartford, East Hartford:(41.7823° N, 72.612° W):Sears, Simeon (1776-1863)" \f "Place" }. They had seven children: Artemesia (1802-1849), Norman (1805-1892), Julius (1807-1889), Emily (1809-1886), Simeon (1811-1897), Edward (1813-1878) and Sarah (1822-1914).

Louisa was born in perh, East Hartford,{ XE "USA, Connecticut, Hartford, East Hartford, perh: :Spencer, Louisa (1777-1844)" \f "Place" } in 1777. She reached 67 years of age and died in Sandisfield, Berkshire, Massachusetts,{ XE "USA, Massachusetts, Berkshire, Sandisfield:(42.1126° N, 73.1432° W):Spencer, Louisa (1777-1844)" \f "Place" } in 1844.

!d ae 67

Children of Simeon Sears and Louisa Spencer:

- f I. **Artemesia⁵ Sears**{ XE "Sears:Artemesia (1802-1849)" \f "Name" \b } was born in Sandisfield, Berkshire, Massachusetts,{ XE "USA, Massachusetts, Berkshire, Sandisfield:(42.1126° N, 73.1432° W):Sears, Artemesia (1802-1849)" \f "Place" } on 8th December 1802. She died on 13th January 1849, at the age of 46.

Artemesia married **Calvin Chapin**{ XE "Chapin:Calvin (1800–1855)" \f "Name" \b \i } in 1825. They had four children: Newton (1828–1829), Newton (1831–1914), Clarissa (1833–1854) and Samuel (1836–).

Calvin was born in Monterey{ XE "USA, Massachusetts, Berkshire, Monterey:(42.1793° N, 73.212° W):Chapin, Calvin (1800–1855)" \f "Place" } on Sunday, 2nd November 1800. He was the son of Peter Chapin{ XE "Chapin:Peter" \f "Name" \i } and Elizabeth Austin{ XE "Austin:Elizabeth" \f "Name" \i }.

Calvin reached 55 years of age and died in New Marlborough{ XE "USA, Massachusetts, Berkshire, New Marlborough:(42.1229° N, 73.2287° W):Chapin, Calvin (1800–1855)" \f "Place" } on 27th December 1855.

[https://www.ancestry.com/family-tree/person/tree/60941953/person/36265837353/facts/tree of Vicki VanSlyke](https://www.ancestry.com/family-tree/person/tree/60941953/person/36265837353/facts/tree%20of%20Vicki%20VanSlyke)

- m II. **Norman Spencer Sears**{ XE "Sears:Norman Spencer (1805–1892)" \f "Name" \b } was born in Sandisfield{ XE "USA, Massachusetts, Berkshire, Sandisfield:(42.1126° N, 73.1432° W):Sears, Norman Spencer (1805–1892)" \f "Place" } on 7th January 1805.^[136, 139] He died on 26th September 1892, at the age of 87.^[136, 139] Norman Spencer was buried at Old Center Cemetery in Monterey, Berkshire County{ XE "USA, Massachusetts, Berkshire County, Monterey:(42.1793° N, 73.212° W):Sears, Norman Spencer (1805–1892)" \f "Place" }.^[136]



Norman

Norman Spencer Sears married **Abigail Jones**{ XE "Jones:Abigail (1803–1836)" \f "Name" \b \i } in 1828 in South Tyringham, Tyringham, Berkshire{ XE "USA, Massachusetts, Berkshire, Tyringham, South Tyringham: :Sears, Norman Spencer (1805–1892)" \f "Place" }. They had four children: Harriet (1830–), Mary (1832–1834), Hiram (1834–1901) and Harlow (1836–1843).

Abigail was born in Sandisfield{ XE "USA, Massachusetts, Berkshire, Sandisfield:(42.1126° N, 73.1432° W):Jones, Abigail (1803–1836)" \f "Place" } in 1803. She reached 33 years of age and died in South Tyringham (now Monterey), Monterey,{ XE "USA, Massachusetts, Berkshire, Monterey, South Tyringham (now Monterey): :Jones, Abigail (1803–1836)" \f "Place" } in 1836.

Norman Spencer Sears married **Olive Spear**{ XE "Spear:Olive (1803–1878)" \f "Name" \b \i } in 1837.^[139] They had two sons: Barnas (1840–1849) and John (1842–1905).

Olive was born in Otis{ XE "USA, Massachusetts, Berkshire, Otis:(42.1932° N, 73.0918° W):Spear, Olive (1803–1878)" \f "Place" } in 1803.^[139] She was the daughter of (unknown given name) Spear{ XE "Spear:(unknown given name)" \f "Name" \i }.

Olive reached 75 years of age and died in Monterey{ XE "USA, Massachusetts, Berkshire, Monterey:(42.1793° N, 73.212° W):Spear, Olive (1803–1878)" \f "Place" } in 1878.^[139]

- m III. **Julius Sears**{ XE "Sears:Julius (1807–1889)" \f "Name" \b } was born in Sandisfield{ XE "USA, Massachusetts, Berkshire, Sandisfield:(42.1126° N, 73.1432° W):Sears, Julius (1807–1889)" \f "Place" } on 3rd April 1807.^[140, 141, 142, 143–144] He died in Vineland,

¹³⁹ Ancestry.com, U.S., Sons of the American Revolution Membership Applications, 1889-1970 (Provo, UT, USA, Ancestry.com Operations, Inc., 2011), Ancestry.com, Volume: 310.

¹⁴⁰ Ancestry.com and The Church of Jesus Christ of Latter-day Saints, 1880 United States Federal Census (Provo, UT, USA, Ancestry.com Operations Inc, 2010), Ancestry.com, Year: 1880; Census Place: Hammonton, Atlantic, New Jersey; Roll: 770; Family History Film: 1254770; Page: 191B; Enumeration District: 007; Image: 0385.

¹⁴¹ Ancestry.com, 1860 United States Federal Census (Provo, UT, USA, Ancestry.com Operations, Inc., 2009), Ancestry.com, Year: 1860; Census Place: Green, Indiana, Pennsylvania; Roll: M653_1116; Page: 213; Family History Library Film: 805116.

¹⁴² Ancestry.com, 1870 United States Federal Census (Provo, UT, USA, Ancestry.com Operations, Inc., 2009), Ancestry.com, Year: 1870; Census Place: Landis, Cumberland, New Jersey; Roll: M593_859; Page: 410A; Image: 345782; Family History Library Film: 552358.

¹⁴³ Ancestry.com, 1850 United States Federal Census (Provo, UT, USA, Ancestry.com Operations, Inc., 2009), Ancestry.com, Year: 1850; Census Place: Sandisfield, Berkshire, Massachusetts; Roll: M432_306; Page: 300B; Image: 598.

¹⁴⁴ Ancestry.com, Selected U.S. Federal Census Non-Population Schedules, 1850-1880 (Provo, UT, USA, Ancestry.com Operations, Inc., 2010), Ancestry.com, Census Year: 1850; Census Place: Sandisfield, Berkshire, Massachusetts; Archive Collection Number: T1204; Roll: 1; Page: 99; Line: 6; Schedule Type: Agriculture.

Cumberland,{ XE "USA, New Jersey, Cumberland, Vineland:(39.4862° N, 75.0257° W):Sears, Julius (1807–1889)" \f "Place" } in 1889 at the age of 81.

More facts and events for Julius Sears:

Residence: 31st August 1850 Sandisfield, Berkshire, Massachusetts{ XE "USA, Massachusetts, Berkshire, Sandisfield:(42.1126° N, 73.1432° W):Sears, Julius (1807–1889)" \f "Place" }^[143, 144]

Residence: 1860 Green, Indiana, Pennsylvania{ XE "USA, Pennsylvania, Indiana, Green:(41.5333° N, 79.3664° W):Sears, Julius (1807–1889)" \f "Place" }^[141]

Residence: 1870 Landis, Cumberland, New Jersey{ XE "USA, New Jersey, Cumberland, Landis:(39.3746° N, 74.9638° W):Sears, Julius (1807–1889)" \f "Place" }^[142]
Post Office: Vineland

Residence: 1880 Hammonton, Atlantic{ XE "USA, New Jersey, Atlantic, Hammonton:(39.6365° N, 74.8024° W):Sears, Julius (1807–1889)" \f "Place" }^[140]
Marital status: Married; Relation to Head of House: Self

Julius Sears married **Mary A Barker**{ XE "Barker:Mary A (1811–)" \f "Name" \b \i }.^[140] They had six children: Mary (1834–1891), Edward (1836–), (unknown given name) (1837–1862), (unknown given name) (1839–), Lucinda (ca.1842–1862) and Milan (1845–1896).

Mary A was born in perh, Sandisfield, Berkshire, Massachusetts,{ XE "USA, Massachusetts, Berkshire, Sandisfield, perh: :Barker, Mary A (1811–)" \f "Place" } in 1811.^[140]

f IV. **Emily B Sears**{ XE "Sears:Emily B (1809–1886)" \f "Name" \b } was born in Sandisfield{ XE "USA, Massachusetts, Berkshire, Sandisfield:(42.1126° N, 73.1432° W):Sears, Emily B (1809–1886)" \f "Place" } on 17th April 1809. She died in Stockbridge{ XE "USA, Massachusetts, Berkshire, Stockbridge:(42.2876° N, 73.3204° W):Sears, Emily B (1809–1886)" \f "Place" } on 27th November 1886, at the age of 77.

At the age of 23, Emily B Sears married **Samuel Thompson**{ XE "Thompson:Samuel (1805–1886)" \f "Name" \b \i } on Friday, 21st September 1832, in Tyringham{ XE "USA, Massachusetts, Berkshire, Tyringham:(42.2459° N, 73.2037° W):Sears, Emily B (1809–1886)" \f "Place" } when he was 27 years old. They had seven children: Merrick (1833–), George (1835–), Frances (1836–), James (1839–), Julia (1841–1919), Rosina (1844–) and Millicent (1848–1877).

Samuel was born in South Tyringham, Tyringham,{ XE "USA, Massachusetts, Berkshire, Tyringham, South Tyringham: :Thompson, Samuel (1805–1886)" \f "Place" } on Friday, 23rd August 1805. He reached 80 years of age and died in Athens, Bradford, Pennsylvania,{ XE "USA, Pennsylvania, Bradford, Athens:(41.9573° N, 76.518° W):Thompson, Samuel (1805–1886)" \f "Place" } on 29th January 1886.

!S.P. May p.230 Removed in 1866 to Hammonton, NJ, and in 1886 to Athens, PA.

m V. **Simeon Sears**{ XE "Sears:Simeon (1811–1897)" \f "Name" \b } was born in Sandisfield{ XE "USA, Massachusetts, Berkshire, Sandisfield:(42.1126° N, 73.1432° W):Sears, Simeon (1811–1897)" \f "Place" } on 13th July 1811.^[137, 145, 146] He died in

¹⁴⁵ Ancestry.com, New Hampshire, Death and Burial Records Index, 1654-1949 (Provo, UT, USA, Ancestry.com Operations, Inc., 2011), Ancestry.com.

Lempster, Sullivan, New Hampshire,{ XE "USA, New Hampshire, Sullivan, Lempster:(43.2384° N, 72.2107° W):Sears, Simeon (1811–1897)" \f "Place" } on 19th September 1897, at the age of 86.^[145] Simeon was buried in New Hampshire{ XE "USA, New Hampshire:(43.6855° N, 71.5776° W):Sears, Simeon (1811–1897)" \f "Place" }.^[145]

Simeon Sears married **Ann Eliza Adams**{ XE "Adams:Ann Eliza (1813–1848)" \f "Name" \b \i } on Wednesday, 5th November 1834, in Sandisfield, Berkshire, Massachusetts{ XE "USA, Massachusetts, Berkshire, Sandisfield:(42.1126° N, 73.1432° W):Sears, Simeon (1811–1897)" \f "Place" }.^[136, 137, 146] They had three children: Laura (1837–1907), Gilbert (1839–) and George (1841–1922).

Ann Eliza was born in perh, Sandisfield,{ XE "USA, Massachusetts, Berkshire, Sandisfield, perh: :Adams, Ann Eliza (1813–1848)" \f "Place" } in 1813.^[137] She reached 35 years of age and died on 23rd December 1848.^[136] Ann Eliza was buried in Le Roy, Genesee County, New York{ XE "USA, New York, Genesee County, Le Roy:(42.9784° N, 77.9842° W):Adams, Ann Eliza (1813–1848)" \f "Place" }.^[136]

m VI. **Edward G Sears**{ XE "Sears:Edward G (1813–1878)" \f "Name" \b } was born in Sandisfield{ XE "USA, Massachusetts, Berkshire, Sandisfield:(42.1126° N, 73.1432° W):Sears, Edward G (1813–1878)" \f "Place" } on 9th December 1813.^[137, 146, 147] He was known by the title of Rev.

Edward G died in Springfield, Hampden,{ XE "USA, Massachusetts, Hampden, Springfield:(42.1015° N, 72.5898° W):Sears, Edward G (1813–1878)" \f "Place" } on 13th November 1878, at the age of 64.^[147]

At the age of 25, Rev Edward G Sears married **Betsy Collamore**{ XE "Collamore:Betsy (1807–1880)" \f "Name" \b \i } on Tuesday, 6th August 1839, in West Scituate, Scituate, Plymouth,{ XE "USA, Massachusetts, Plymouth, Scituate, West Scituate: :Sears, Edward G (1813–1878)" \f "Place" } when she was 31 years old.^[137, 146, 147] They had three children: Elizabeth (1841–1841), Edward (1844–1927) and Andrew (1848–1849).

Betsy was born in West Scituate{ XE "USA, Massachusetts, Plymouth, Scituate, West Scituate: :Collamore, Betsy (1807–1880)" \f "Place" } on Sunday, 15th November 1807.^[147] She reached 72 years of age and died in St Albans, Franklin, Vermont,{ XE "USA, Vermont, Franklin, St Albans:(44.8108° N, 73.0836° W):Collamore, Betsy (1807–1880)" \f "Place" } on 5th May 1880.^[147]

f VII. **Sarah Lovisa Sears**{ XE "Sears:Sarah Lovisa (1822–1914)" \f "Name" \b } was born in Sandisfield{ XE "USA, Massachusetts, Berkshire, Sandisfield:(42.1126° N, 73.1432° W):Sears, Sarah Lovisa (1822–1914)" \f "Place" } in 1822. She died in Dundee, Kane, Illinois,{ XE "USA, Illinois, Kane, Dundee:(42.0976° N, 88.2786° W):Sears, Sarah Lovisa (1822–1914)" \f "Place" } on 15th October 1914, at the age of 92.

Sarah Lovisa Sears married **Rev Henry Barlow**{ XE "Barlow:Henry (–1853)" \f "Name" \b \i } on Friday, 20th November 1846, in New Milford, Litchfield, Connecticut{ XE "USA, Connecticut, Litchfield, New Milford:(41.577° N, 73.4084° W):Sears, Sarah Lovisa (1822–1914)" \f "Place" }. They had two daughters: Emma (1849–1932) and Henrietta (1851–1940).

Henry died in Illinois{ XE "USA, Illinois:(39.7333° N, 88.5° W):Barlow, Henry (–1853)" \f "Place" } in 1853.

¹⁴⁶ Dodd, Jordan, Liahona Research, comp, Massachusetts, Marriages, 1633-1850 (Provo, UT, USA, Ancestry.com Operations Inc, 2005), Ancestry.com.

¹⁴⁷ Ancestry.com, U.S., Sons of the American Revolution Membership Applications, 1889-1970 (Provo, UT, USA, Ancestry.com Operations, Inc., 2011), Ancestry.com, Volume: 222.

Family of Esther Sears and Gillette Hawley{ TC "Esther Sears and Gillette Hawley" \I 3 \f C}

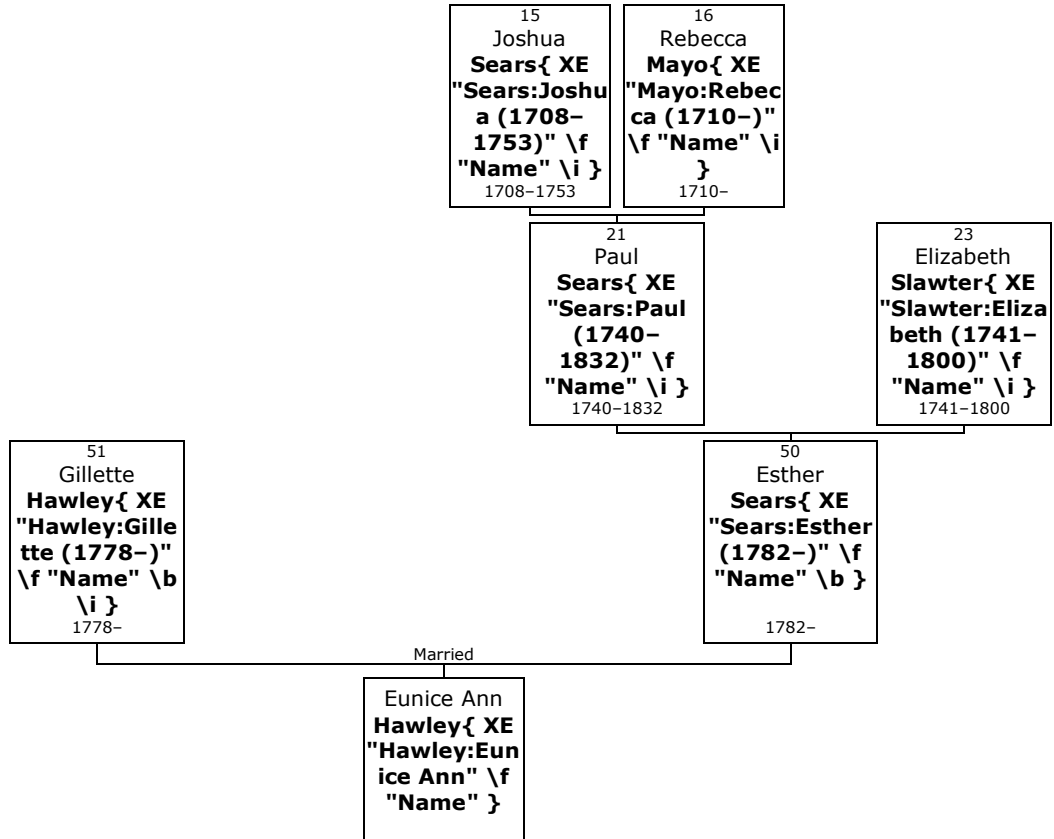

50. **Esther⁴ Sears**{ XE "Sears:Esther (1782-)" \f "Name" \b } (*Paul³, Joshua²*) was born on Sunday, 23rd June 1782, in Sandisfield, Berkshire, Massachusetts, USA{ XE "USA, Massachusetts, Berkshire, Sandisfield:(42.1126° N, 73.1432° W):Sears, Esther (1782-)" \f "Place" }. She was the daughter of Paul Sears{ XE "Sears:Paul (1740-1832)" \f "Name" \i } (21) and Elizabeth Slawter{ XE "Slawter:Elizabeth (1741-1800)" \f "Name" \i } (23).

!S P May No 546
<https://www.wikitree.com/wiki/Sears-4479>

51. She married **Gillette Hawley**{ XE "Hawley:Gillette (1778-)" \f "Name" \b \i }. They had one daughter: Eunice.

Gillette was born in perh, Sandisfield,{ XE "USA, Massachusetts, Berkshire, Sandisfield, perh: :Hawley, Gillette (1778-)" \f "Place" } in 1778.

Daughter of Esther Sears and Gillette Hawley:

f I. **Eunice Ann⁵ Hawley**{ XE "Hawley:Eunice Ann" \f "Name" \b }.

Eunice Ann married **George Gasner**{ XE "Gasner:George" \f "Name" \b \i }.

Family of Joseph Sears and Sarah Pitts{ TC "Joseph Sears and Sarah Pitts" \I 3 \f C}

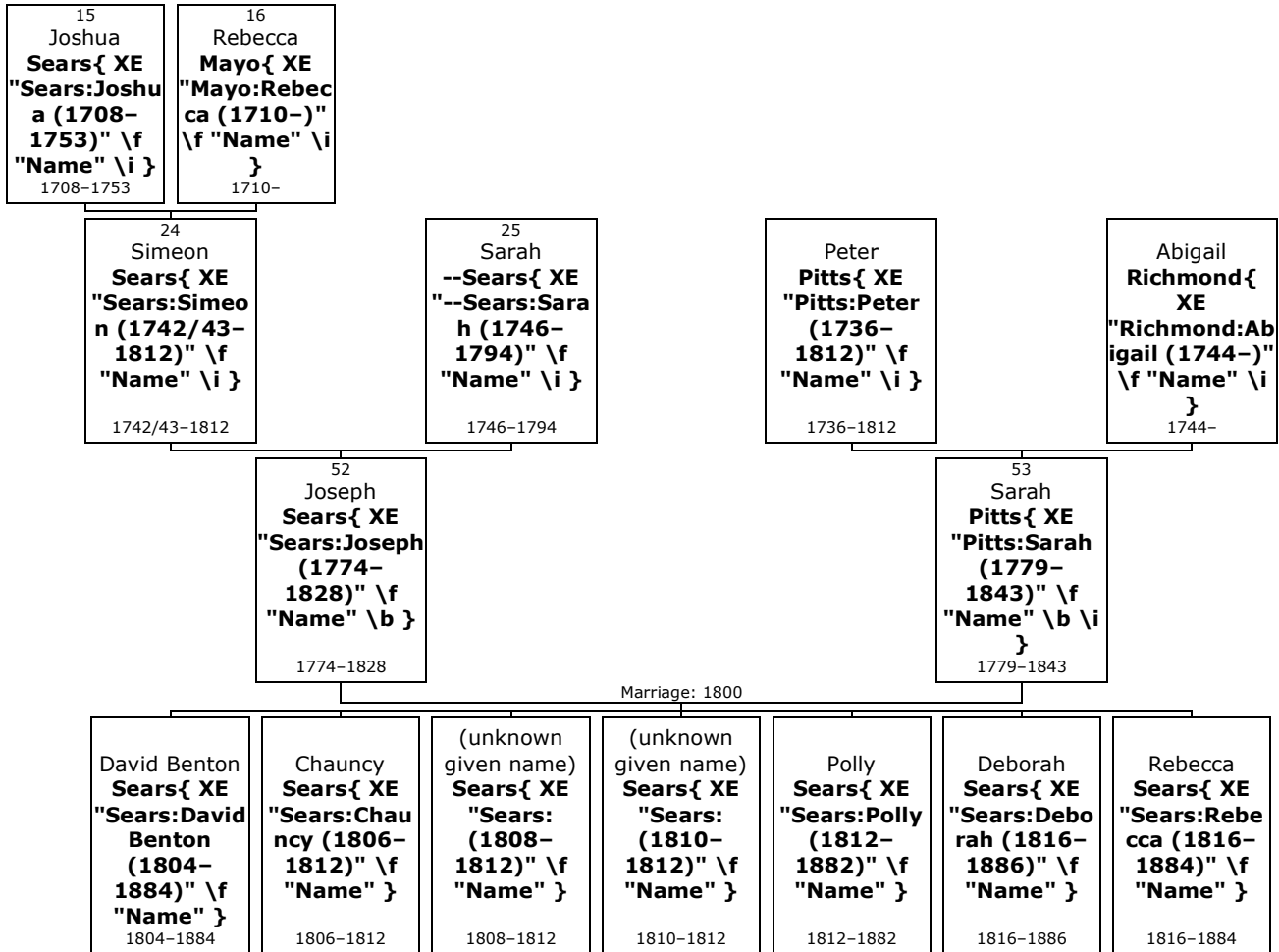

52. **Joseph⁴ Sears**{ XE "Sears:Joseph (1774-1828)" \f "Name" \b } (*Simeon³, Joshua²*) was born in 1774 in perh, Bennington, Vermont, USA{ XE "USA, Vermont, Bennington, perh: :Sears, Joseph (1774-1828)" \f "Place" \i }. He was the son of Simeon Sears{ XE "Sears:Simeon (1742/43-1812)" \f "Name" \i } (24) and Sarah --Sears{ XE "--Sears:Sarah (1746-1794)" \f "Name" \i } (25).

Joseph died in Shawneetown, Gallatin, Illinois,{ XE "USA, Illinois, Gallatin, Shawneetown:(37.7131° N, 88.1867° W):Sears, Joseph (1774-1828)" \f "Place" \i } in 1828 at the age of 54.

!S P May No 550 p.231 Joseph Sears removed to Lima, NY, in 1796, and thence in the fall of 1811, to Huron co., OH, and in 1814, to Switzerland co., IN, and finally to Wabash Valley, IL, in 1818. His family suffered great hardships while residing in the Sciota Valley during the war of 1812, and were frequently imperiled by the attack of marauding Indians. They were finally obliged to flee to Fort Erie for safety, but in crossing the Sciota river their boat was upset, and three of the children were drowned.

<https://www.wikitree.com/wiki/Sears-3025>

53. Joseph married **Sarah Pitts**{ XE "Pitts:Sarah (1779-1843)" \f "Name" \b \i } in 1800. They had seven children: David (1804-1884), Chauncy (1806-1812), (unknown given name) (1808-1812), (unknown given name) (1810-1812), Polly (1812-1882), Deborah (1816-1886) and Rebecca (1816-1884). Sarah was born in perh, Lima, Livingston, New York,{ XE "USA, New York, Livingston, Lima, perh: :Pitts, Sarah (1779-1843)" \f "Place" \i } in 1779. She was the daughter of Peter Pitts{ XE "Pitts:Peter (1736-1812)" \f "Name" \i } and Abigail Richmond{ XE "Richmond:Abigail (1744-)" \f "Name" \i }. Sarah reached 64 years of age and died in 1843.

Children of Joseph Sears and Sarah Pitts:

- m I. **David Benton⁵ Sears**{ XE "Sears:David Benton (1804-1884)" \f "Name" \b } was born in Lima{ XE "USA, New York, Livingston, Lima:(42.9048° N, 77.6114° W):Sears, David

Benton (1804–1884)" \f "Place" } on 28th April 1804.^[148, 149, 150, 151-152] He served in the military in Illinois{ XE "USA, Illinois:(39.7333° N, 88.5° W):Sears, David Benton (1804–1884)" \f "Place" }.^[152]

David Benton died in Sears, Rock Island, Illinois,{ XE "USA, Illinois, Rock Island, Sears: :Sears, David Benton (1804–1884)" \f "Place" } on 22nd January 1884, at the age of 79.^[148] He was buried in Moline{ XE "USA, Illinois, Rock Island, Moline:(41.5067° N, 90.5151° W):Sears, David Benton (1804–1884)" \f "Place" }.^[148]

David Benton married **Melinda Stokes**{ XE "Stokes:Melinda (1803–1835)" \f "Name" \b \i } in 1824 in Shawneetown, Gallatin{ XE "USA, Illinois, Gallatin, Shawneetown:(37.7131° N, 88.1867° W):Sears, David Benton (1804–1884)" \f "Place" }.^[149] They had five daughters: Melinda (1825–), Mary (1828–1866), Abigail (1830–), Sarah (ca.1832–1907) and Caroline (1834–1904).

Melinda was born in Shawneetown{ XE "USA, Illinois, Gallatin, Shawneetown:(37.7131° N, 88.1867° W):Stokes, Melinda (1803–1835)" \f "Place" } in 1803.^[149] She was the daughter of Edmond Stokes{ XE "Stokes:Edmond" \f "Name" \i } and Judith Taylor{ XE "Taylor:Judith" \f "Name" \i }.

Melinda reached 32 years of age and died in Shawneetown{ XE "USA, Illinois, Gallatin, Shawneetown:(37.7131° N, 88.1867° W):Stokes, Melinda (1803–1835)" \f "Place" } in 1835.

<https://www.wikitree.com/wiki/Stokes-3515>

David Benton Sears married **Delia Caldwell**{ XE "Caldwell:Delia (1813–1862)" \f "Name" \b \i } in 1835 in Shawneetown{ XE "USA, Illinois, Gallatin, Shawneetown:(37.7131° N, 88.1867° W):Sears, David Benton (1804–1884)" \f "Place" }.^[148] They had eight children: Polly (1836–), Margaret (1838–1838), David (1839–1933), William (1840–1917), George (1842–1914), Barbara (1845–1847), Janett (1848–1898) and Henry (1850–1891).

Delia was born in Kentucky{ XE "USA, Kentucky:(37.825° N, 84.2333° W):Caldwell, Delia (1813–1862)" \f "Place" } in 1813.^[148] She reached 49 years of age and died in Moline, Rock Island, Illinois,{ XE "USA, Illinois, Rock Island, Moline:(41.5067° N, 90.5151° W):Caldwell, Delia (1813–1862)" \f "Place" } on 28th June 1862.^[148] Delia was buried in Moline{ XE "USA, Illinois, Rock Island, Moline:(41.5067° N, 90.5151° W):Caldwell, Delia (1813–1862)" \f "Place" }.^[148]

David Benton married **Eunice Grant Sayles**{ XE "Sayles:Eunice Grant" \f "Name" \b \i }.

- m II. **Chauncy Sears**{ XE "Sears:Chauncy (1806–1812)" \f "Name" \b } was born in perh, Lima,{ XE "USA, New York, Livingston, Lima, perh: :Sears, Chauncy (1806–1812)" \f "Place" } in 1806. He died in 1812 at the age of 6.
- f III. **(unknown given name) Sears**{ XE "Sears: (1808–1812)" \f "Name" \b } was born in perh{ XE "USA, New York, Livingston, Lima, perh: :Sears, (1808–1812)" \f "Place" } in 1808. She died in 1812 at the age of 4. Sciota River.
- f IV. **(unknown given name) Sears**{ XE "Sears: (1810–1812)" \f "Name" \b } was born in perh{ XE "USA, New York, Livingston, Lima, perh: :Sears, (1810–1812)" \f "Place" } in 1810. She died in 1812 at the age of 2. Sciota River.

¹⁴⁸ Ancestry.com, U.S., Find A Grave Index, 1600s-Current (Provo, UT, USA, Ancestry.com Operations, Inc., 2012), Ancestry.com.

¹⁴⁹ Ancestry.com, Pennsylvania, Death Certificates, 1906-1963 (Provo, UT, USA, Ancestry.com Operations, Inc., 2014), Ancestry.com, Pennsylvania Historic and Museum Commission; Pennsylvania, USA; Certificate Number Range: 003631-007060.

¹⁵⁰ Ancestry.com, Illinois, Marriage Index, 1860-1920 (Provo, UT, USA, Ancestry.com Operations, Inc., 2015), Ancestry.com.

¹⁵¹ Jordan Dodd and Liahona Research, comp., Illinois, Marriage Index, 1851-1900 (Provo, UT, USA, Ancestry.com Operations Inc, 2005), Ancestry.com.

¹⁵² National Park Service, U.S. Civil War Soldiers, 1861-1865 (Provo, UT, USA, Ancestry.com Operations Inc, 2007), Ancestry.com.

- f V. **Polly Sears**{ XE "Sears:Polly (1812–1882)" \f "Name" \b } was born in perh{ XE "USA, New York, Livingston, Lima, perh: :Sears, Polly (1812–1882)" \f "Place" } in 1812. She died in 1882 at the age of 70.
Polly married (**unknown given name**) **Jackson**{ XE "Jackson:(unknown given name)" \f "Name" \b \i }.
Polly married **Donohue Williams**{ XE "Williams:Donohue" \f "Name" \b \i }.
- f VI. **Deborah Sears**{ XE "Sears:Deborah (1816–1886)" \f "Name" \b } was born in perh{ XE "USA, New York, Livingston, Lima, perh: :Sears, Deborah (1816–1886)" \f "Place" } in 1816. She died in 1886 at the age of 70.
Deborah married **William L Lee**{ XE "Lee:William L" \f "Name" \b \i }.
- f VII. **Rebecca Sears**{ XE "Sears:Rebecca (1816–1884)" \f "Name" \b } was born in Indiana{ XE "USA, Indiana:(39.775° N, 85.5584° W):Sears, Rebecca (1816–1884)" \f "Place" } on 17th March 1816.^[148, 153, 154, 155, 156, 157, 158–159] She died in Moline{ XE "USA, Illinois, Rock Island, Moline:(41.5067° N, 90.5151° W):Sears, Rebecca (1816–1884)" \f "Place" } in 1884 at the age of 67.^[148, 157] Rebecca was buried in Moline{ XE "USA, Illinois, Rock Island, Moline:(41.5067° N, 90.5151° W):Sears, Rebecca (1816–1884)" \f "Place" }.^[148, 157]

More facts and events for Rebecca Sears:

- Residence: 1850 Black River, Sheboygan, Wisconsin{ XE "USA, Wisconsin, Sheboygan, Black River:(43.6949° N, 87.7113° W):Sears, Rebecca (1816–1884)" \f "Place" }^[156]
- Residence: 1860 Moline, Rock Island, Illinois{ XE "USA, Illinois, Rock Island, Moline:(41.5067° N, 90.5151° W):Sears, Rebecca (1816–1884)" \f "Place" }^[154]
- Residence: 1870 western, Henry{ XE "USA, Illinois, Henry, western: :Sears, Rebecca (1816–1884)" \f "Place" }^[155]
Post Office: Orion
- Residence: 1880 Sears, Rock Island{ XE "USA, Illinois, Rock Island, Sears: :Sears, Rebecca (1816–1884)" \f "Place" }^[153]
Marital status: Widowed; Relation to Head of House: Self

At the age of 17, Rebecca married **Timothy Wood**{ XE "Wood:Timothy (1810–1878)" \f "Name" \b \i } on Thursday, 20th February 1834, in Gallatin{ XE "USA, Illinois, Gallatin:(37.758° N, 88.2294° W):Sears, Rebecca (1816–1884)" \f "Place" } when he was 23 years old.^[148, 158, 159] They had seven children: Frances (1834–1839), Charles (1836–1858), Wellington (1839–1863), Benton (1842–1922), Pitts (1848–1924), Tim (1850–ca.1882) and Richmond (1862–1930).

¹⁵³ Ancestry.com and The Church of Jesus Christ of Latter-day Saints, 1880 United States Federal Census (Provo, UT, USA, Ancestry.com Operations Inc, 2010), Ancestry.com, Year: 1880; Census Place: Sears, Rock Island, Illinois; Roll: 246; Family History Film: 1254246; Page: 600C; Enumeration District: 259; Image: 0448.

¹⁵⁴ Ancestry.com, 1860 United States Federal Census (Provo, UT, USA, Ancestry.com Operations, Inc., 2009), Ancestry.com, Year: 1860; Census Place: Moline, Rock Island, Illinois; Roll: M653_222; Page: 536; Image: 536; Family History Library Film: 803222.

¹⁵⁵ Ancestry.com, 1870 United States Federal Census (Provo, UT, USA, Ancestry.com Operations, Inc., 2009), Ancestry.com, Year: 1870; Census Place: Western, Henry, Illinois; Roll: M593_230; Page: 170A; Image: 87049; Family History Library Film: 545729.

¹⁵⁶ Ancestry.com, 1850 United States Federal Census (Provo, UT, USA, Ancestry.com Operations, Inc., 2009), Ancestry.com, Year: 1850; Census Place: Black River, Crawford, Wisconsin; Roll: M432_995; Page: 261B; Image: 57.

¹⁵⁷ Ancestry.com, Web: Illinois, Find A Grave Index, 1809–2012 (Provo, UT, USA, Ancestry.com Operations, Inc., 2012), Ancestry.com.

¹⁵⁸ Dodd, Jordan, Liahona Research, comp, Illinois Marriages, 1790–1860 (Provo, UT, USA, Ancestry.com Operations Inc, 2004), Ancestry.com.

¹⁵⁹ Dodd, Jordan, Illinois Marriages to 1850 (Provo, UT, USA, Ancestry.com Operations Inc, 1997), Ancestry.com.

Timothy was born in Amenia, Dutchess, New York, { XE "USA, New York, Dutchess, Amenia:(41.8493° N, 73.5568° W):Wood, Timothy (1810–1878)" \f "Place" } on Tuesday, 27th November 1810.^[148] He reached 67 years of age and died in Moline, Rock Island, Illinois, { XE "USA, Illinois, Rock Island, Moline:(41.5067° N, 90.5151° W):Wood, Timothy (1810–1878)" \f "Place" } on 13th August 1878.^[148] Timothy was buried in Moline { XE "USA, Illinois, Rock Island, Moline:(41.5067° N, 90.5151° W):Wood, Timothy (1810–1878)" \f "Place" }.^[148]

Info from Fred F Wood- The Wood Book 3d Ed

Rhoda Sears { TC "Rhoda Sears" \I 3 \f C }

54. Rhoda⁴ Sears { XE "Sears:Rhoda (1776–1854)" \f "Name" \b } (*Simeon³, Joshua²*) was born in 1776 in Bennington, Vermont, USA { XE "USA, Vermont, Bennington:(43.0293° N, 73.1084° W):Sears, Rhoda (1776–1854)" \f "Place" }.^[160] She was the daughter of Simeon Sears { XE "Sears:Simeon (1742/43–1812)" \f "Name" \i } (24) and Sarah --Sears { XE "--Sears:Sarah (1746–1794)" \f "Name" \i } (25).

Rhoda died in Pawlet, Rutland, { XE "USA, Vermont, Rutland, Pawlet:(43.3467° N, 73.1767° W):Sears, Rhoda (1776–1854)" \f "Place" } on 6th January 1854, at the age of 78.

!S P May No 551

!

!https://www.wikitree.com/wiki/Sears-4471

!J W Sears: d.

From: Connie Duke [mailto:duke@up.net] Sent: Tuesday, November 08, 2005 1:56 PM To: LRSEARS@CAPECOD.NET Subject: Sears family I am a descendant of Rhoda Sears, b. 1776 Bennington, VT, d/o Simeon Sears. I'm trying to determine who the wife of Simeon was and do not believe she was as everyone says, Tryphena or Polly Hurlburt. I found a record of Early Church Records of First Congregational Church, Bennington, VT, that apparently is a baptism record saying: Sears, Simeon and Sarah - Rhoda 1777, Elisha 1778. Another entry says Sears, Simeon - Lucy, Sarah, Simeon 1777. To me this indicates that Simeon's wife was named Sarah _____.

Simeon Sears of Sandersfield, MA, married Mary Hulbert on 2 Nov 1797 at Enfield, CT. She was more than likely the Polly Hurlburt who married Simeon Sears and not the one above. By the way, Rhoda Sears was married first to Ephraim Fitch but he died in 1813 and she married 2) his brother, Joseph Fitch Jr. who I am descended from. They moved to Oxford Co, ON, and then on to Milford, Oakland Co, MI, where Joseph Jr. died in 1840. Rhoda returned to Pawlet, VT where she died in 1854.

Connie Duke duke@up.net

From: Connie Duke [mailto:duke@up.net] Sent: Saturday, July 22, 2006 7:42 PM To: Ray Subject: Re: Sears family Hi Ray: Have not heard of or seen Samuel May's book about the Sears family. Thank you for the below info about Simeon. He sure seemed to move a lot!! Do you have any idea when Simeon Sears died? He was on the 1790 census at Rutland Co, VT, but gone by 1800. Rhoda Sears, b. 1776 Bennington, VT; d. 6 Jan 1854 Pawlet Twp, Rutland Co, VT, age 77, dau of Simeon Sears and Sarah _____. She married 1) Ephraim FITCH on 15 Oct 1797 Pawlet, Rutland Co, VT; b. 12 Feb 1768 Norwich CT; d. 9 Jan 1813 Pawlet Twp, Rutland Co, VT, son of Joseph FITCH Sr. and Mary ANDRUS. Their children were: a. Nancy Fitch, b. 26 Mar 1799 Rutland Co, VT; d. 4 Nov 1860 Lorain Co, OH. b. George Fitch, b. 13 Dec 1801 Rutland Co, VT c. Ferris Fitch, b. 3 Nov 1802 Rutland Co, VT; d. 30 Jun 1846 Lower Sandusky, OH. d. Catherine Fitch, b. 1806 Rutland Co, VT; d. 21 Apr 1808 Rutland Co, VT. e. Catherine Fitch, b. 1808 Rutland Co, VT; d. 19 Sep 1830 Addison Co, VT. f. Moses Porter Fitch, b. 1811 Rutland Co, VT. She married 2) Joseph FITCH Jr. between 1813-1815 ?VT; b. 18 Feb 1775 Rutland Co, VT; d. 9 Apr 1840 Milford, Oakland Co, MI, son of Joseph FITCH Sr. and Mary ANDRUS. Their children were: g. Cordelia Fitch, b. c1815 VT h. Ephraim Fitch, b. c1818 VT; d. c1867 ?Lapeer Co, MI, after serving in the Union Army in the Civil War. i. Joseph H. Fitch, b. 7 Nov 1819 Niagara Co, NY; d. 17 Mar 1873 Kent Co, MI. j. Anna Fitch, b. c1823 Oxford Co, Ontario, Canada

!Rhoda Sears was the 2nd wife of both Ephraim and Joseph Jr. When she and Joseph Jr. moved to NY and then to Canada, there is no indication that any of her living children from her marriage to Ephraim moved with them but Moses Porter Fitch did move to MI after 1860 as did an older son of Ephraim's from his 1st marriage. The 4 children of Joseph's first marriage did move with them though to NY and Canada. Connie Duke duke@up.net

¹⁶⁰ Ancestry.com, Michigan, Death Records, 1867-1950 (Provo, UT, USA, Ancestry.com Operations, Inc., 2015), Ancestry.com. [Source citation includes one media item]

Marriages with Ephraim Fitch and Joseph Fitch Jr (Page 104) are known.

Family of Rhoda Sears and Ephraim Fitch { TC "Rhoda Sears and Ephraim Fitch" \I 4 \f C}

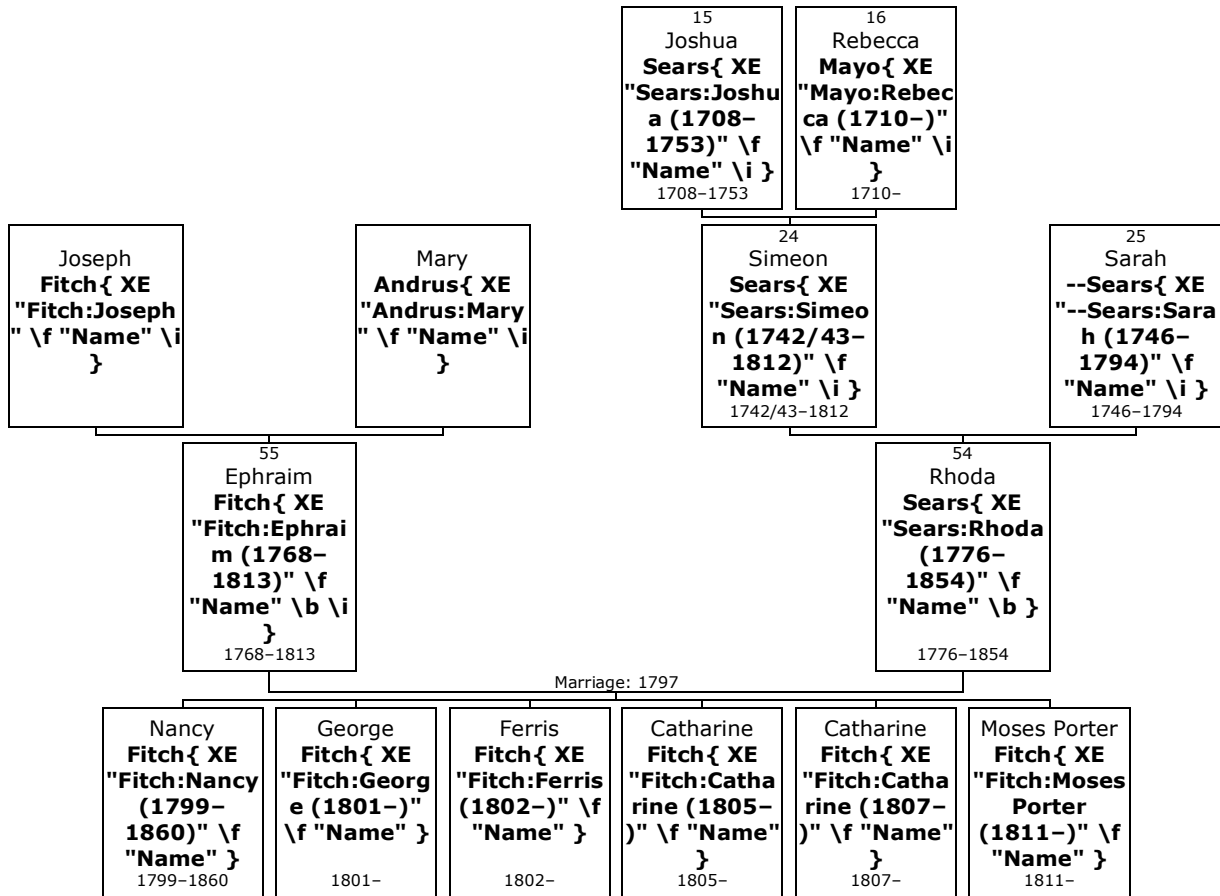

Here are the details about **Rhoda Sears** { XE "Sears:Rhoda (1776-1854)" \f "Name" \b } first marriage, with Ephraim Fitch. You can read more about Rhoda on page 101.

- 55.** At the age of 21, Rhoda Sears married **Ephraim Fitch** { XE "Fitch:Ephraim (1768-1813)" \f "Name" \b \i } on Sunday, 15th October 1797, in Pawlet, Rutland, { XE "USA, Vermont, Rutland, Pawlet:(43.3467° N, 73.1767° W):Sears, Rhoda (1776-1854)" \f "Place" } when he was 29 years old. They had six children: Nancy (1799-1860), George (1801-), Ferris (1802-), Catharine (1805-), Catharine (1807-) and Moses (1811-).

Ephraim was born in Norwich, New London, Connecticut, { XE "USA, Connecticut, New London, Norwich:(41.5243° N, 72.0759° W):Fitch, Ephraim (1768-1813)" \f "Place" } on Friday, 12th February 1768. He was the son of Joseph Fitch { XE "Fitch:Joseph" \f "Name" \i } and Mary Andrus { XE "Andrus:Mary" \f "Name" \i }.

Ephraim reached 44 years of age and died in Pawlet, Rutland, Vermont, { XE "USA, Vermont, Rutland, Pawlet:(43.3467° N, 73.1767° W):Fitch, Ephraim (1768-1813)" \f "Place" } on 9th January 1813.

!b. also shown as 1768

Children of Rhoda Sears and Ephraim Fitch:

- f I. **Nancy⁵ Fitch** { XE "Fitch:Nancy (1799-1860)" \f "Name" \b } was born in Rutland { XE "USA, Vermont, Rutland:(43.5742° N, 73.035° W):Fitch, Nancy (1799-1860)" \f "Place" } on 26th March 1799. She died in Lorain, Ohio, { XE "USA, Ohio, Lorain:(41.4662° N, 82.1542° W):Fitch, Nancy (1799-1860)" \f "Place" } on 4th November 1860, at the age of 61.

Nancy married **Dr James Willard** { XE "Willard:James (-1858)" \f "Name" \b \i } on Sunday, 13th September 1818. They had no known children.

James was born in Pawlet, Rutland, Vermont { XE "USA, Vermont, Rutland, Pawlet:(43.3467° N, 73.1767° W):Willard, James (-1858)" \f "Place" }. He died in 1858.

- m II. **George Fitch**{ XE "Fitch:George (1801-)" \f "Name" \b } was born in Rutland{ XE "USA, Vermont, Rutland:(43.5742° N, 73.035° W):Fitch, George (1801-)" \f "Place" } on 13th December 1801.
- m III. **Ferris Fitch**{ XE "Fitch:Ferris (1802-)" \f "Name" \b } was born in perh, Pawlet, Rutland,{ XE "USA, Vermont, Rutland, Pawlet, perh: :Fitch, Ferris (1802-)" \f "Place" } on 3rd October 1802.
 Ferris married **Sally Porter**{ XE "Porter:Sally" \f "Name" \b \i }.
- f IV. **Catharine Fitch**{ XE "Fitch:Catharine (1805-)" \f "Name" \b } was born in perh{ XE "USA, Vermont, Rutland, Pawlet, perh: :Fitch, Catharine (1805-)" \f "Place" } in 1805.
- f V. **Catharine Fitch**{ XE "Fitch:Catharine (1807-)" \f "Name" \b } was born in perh{ XE "USA, Vermont, Rutland, Pawlet, perh: :Fitch, Catharine (1807-)" \f "Place" } in 1807.
- m VI. **Moses Porter Fitch**{ XE "Fitch:Moses Porter (1811-)" \f "Name" \b } was born in Pawlet{ XE "USA, Vermont, Rutland, Pawlet:(43.3467° N, 73.1767° W):Fitch, Moses Porter (1811-)" \f "Place" } in 1811.
 Moses Porter married **Chloe Atwater Cook**{ XE "Cook:Chloe Atwater (1819-)" \f "Name" \b \i } on Tuesday, 16th June 1840, in Granville, Washington, New York{ XE "USA, New York, Washington, Granville:(43.4079° N, 73.2595° W):Fitch, Moses Porter (1811-)" \f "Place" }. They had two daughters: Martha (1841-) and Mary (1843-).
 Chloe Atwater was born in perh, Granville,{ XE "USA, New York, Washington, Granville, perh: :Cook, Chloe Atwater (1819-)" \f "Place" } in 1819.
 !S.P. May p.139 She is a descendant of Francis Cook, "The Pilgrim"

Family of Rhoda Sears and Joseph Fitch{ TC "Rhoda Sears and Joseph Fitch" \I 4 \f C}

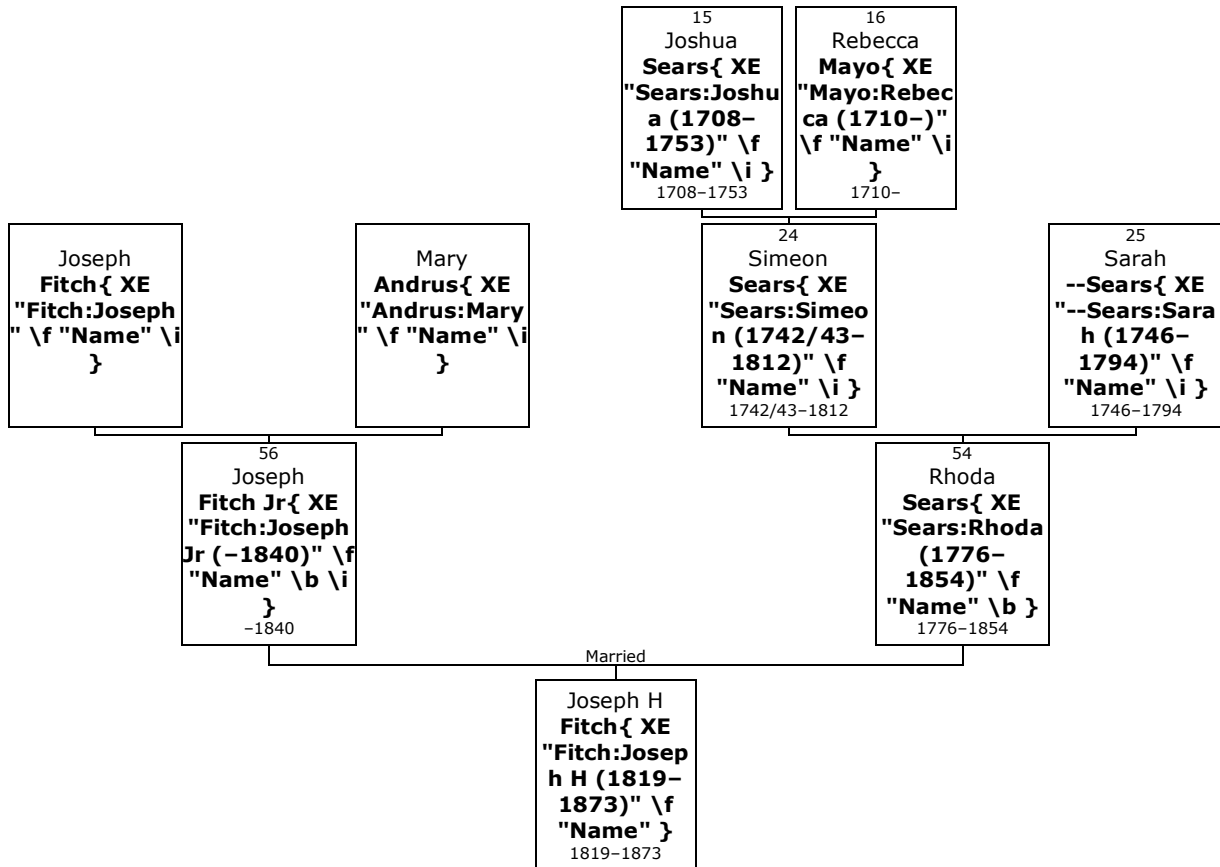

Here are the details about **Rhoda Sears**{ XE "Sears:Rhoda (1776-1854)" \f "Name" \b } second marriage, with Joseph Fitch Jr. You can read more about Rhoda on page 101.

- 56.** Rhoda Sears married **Joseph Fitch Jr**{ XE "Fitch:Joseph Jr (-1840)" \f "Name" \b \i }.^[160] They had one son: Joseph (1819–1873). He was the son of Joseph Fitch{ XE "Fitch:Joseph" \f "Name" \i } and Mary Andrus{ XE "Andrus:Mary" \f "Name" \i }.

Joseph died in Milford, Oakland, Michigan,{ XE "USA, Michigan, Oakland, Milford:(42.5936° N, 83.5994° W):Fitch, Joseph Jr (-1840)" \f "Place" } in 1840.

Son of Rhoda Sears and Joseph Fitch Jr:

- m I. **Joseph H⁵ Fitch**{ XE "Fitch:Joseph H (1819–1873)" \f "Name" \b } was born in New York{ XE "USA, New York:(42.7531° N, 74.2224° W):Fitch, Joseph H (1819–1873)" \f "Place" } in 1819.^[160] He died in Algoma, Kent, Michigan,{ XE "USA, Michigan, Kent, Algoma:(43.1667° N, 85.6083° W):Fitch, Joseph H (1819–1873)" \f "Place" } on 17th March 1873, at the age of 54.^[160]

Family of Daniel Sears and Cynthia Scott{ TC "Daniel Sears and Cynthia Scott" \I 3 \f C}

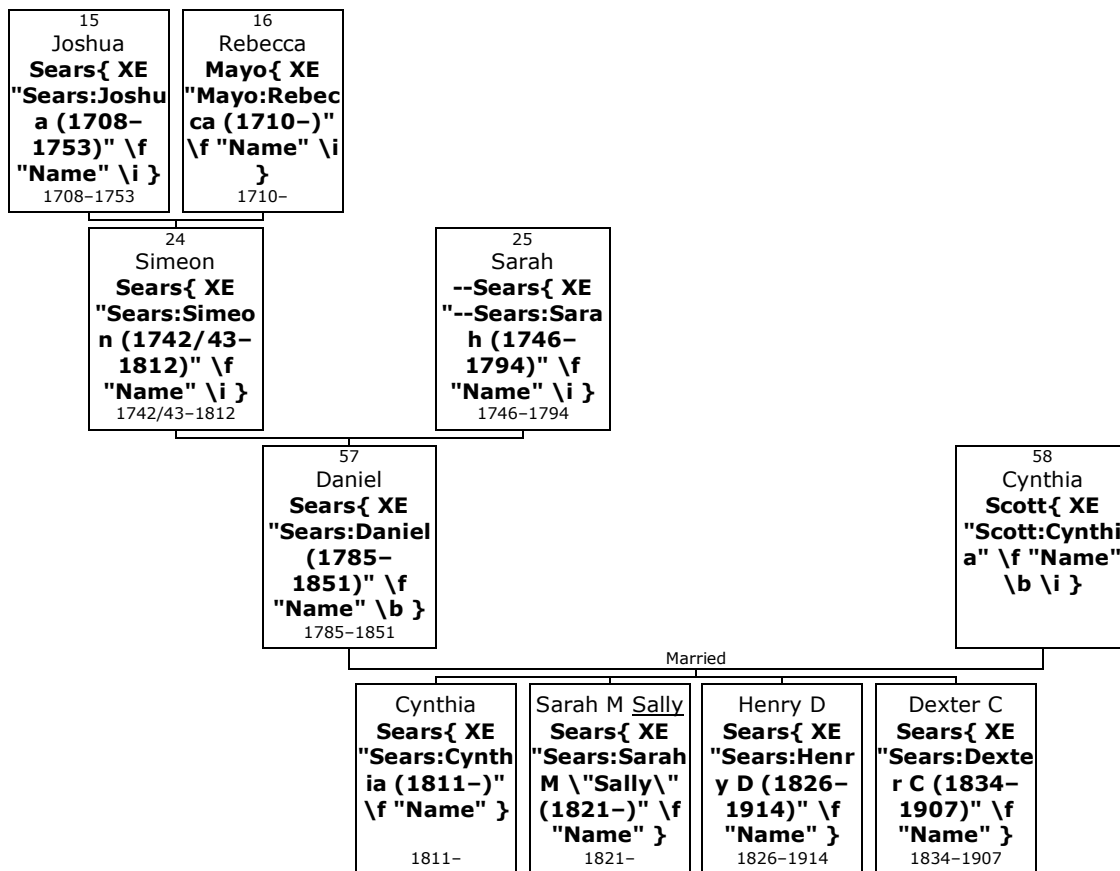

- 57.** **Daniel⁴ Sears**{ XE "Sears:Daniel (1785–1851)" \f "Name" \b } (*Simeon³, Joshua²*) was born in Vermont, USA{ XE "USA, Vermont:(43.8726° N, 71.55° W):Sears, Daniel (1785–1851)" \f "Place" }.^[161] He was the son of Simeon Sears{ XE "Sears:Simeon (1742/43–1812)" \f "Name" \i } (24) and Sarah --Sears{ XE "--Sears:Sarah (1746–1794)" \f "Name" \i } (25). He was also known as **David Sears**{ XE "Sears:David (Daniel Sears) (1785–1851)" \f "Name" }.^[161]

Daniel died in St Lawrence{ XE "USA, New York, St Lawrence:(44.5785° N, 75.2597° W):Sears, Daniel (1785–1851)" \f "Place" } in 1851 at the age of 66.

so, is this the right Daniel?? but someone says David

*1850 United States Federal Census about Daniel Sears [David Sears] Age: 65 Birth Year: abt 1785

¹⁶¹ Ancestry.com, 1850 United States Federal Census (Provo, UT, USA, Ancestry.com Operations, Inc., 2009), Ancestry.com, Year: 1850; Census Place: Gouverneur, Saint Lawrence, New York; Roll: M432_589; Page: 194B; Image: 396. Record for Daniel Sears. <http://search.ancestry.com/cgi-bin/sse.dll?db=8054&h=8268369&indiv=try>. [Source citation includes one media item]

Birthplace: Vermont Home in 1850: Gouverneur, Saint Lawrence, New York Gender: Male Family Number: 325 Household Members: Name Age Daniel Sears 65 Cynthia Sears 59 Dexter C Sears 17

More facts and events for Daniel Sears:

Residence: 1850 Gouverneur, St Lawrence{ XE "USA, New York, St Lawrence, Gouverneur:(44.3367° N, 75.463° W):Sears, Daniel (1785–1851)" \f "Place" }^[161]
Age: 65

58. He married **Cynthia Scott**{ XE "Scott:Cynthia" \f "Name" \b \i }. They had four children: Cynthia (1811–), Sally (1821–), Henry (1826–1914) and Dexter (1834–1907).

Children of Daniel Sears and Cynthia Scott:

- f I. **Cynthia⁵ Sears**{ XE "Sears:Cynthia (1811–)" \f "Name" \b } was born in 1811.
- f II. **Sarah M Sally Sears**{ XE "Sears:Sarah M \"Sally\" (1821–)" \f "Name" \b } was born in 1821.
- m III. **Henry D Sears**{ XE "Sears:Henry D (1826–1914)" \f "Name" \b } was born in New York{ XE "USA, New York:(42.7531° N, 74.2224° W):Sears, Henry D (1826–1914)" \f "Place" } in 1826.^[162, 163, 164–165] He died in 1914 at the age of 88.



Henry

More facts and events for Henry D Sears:

Residence: 1880 Berlin, Green Lake, Wisconsin{ XE "USA, Wisconsin, Green Lake, Berlin:(43.968° N, 88.9435° W):Sears, Henry D (1826–1914)" \f "Place" }^[164]
Marital status: Married; Relation to Head of House: Self

Residence: 1st June 1905 Berlin{ XE "USA, Wisconsin, Green Lake, Berlin:(43.968° N, 88.9435° W):Sears, Henry D (1826–1914)" \f "Place" }^[163]
Marital Status: Married; Relation to Head of House: Head

Residence: 1910 Ward 1, Des Moines, Polk, Iowa{ XE "USA, Iowa, Polk, Des Moines, Ward 1: :Sears, Henry D (1826–1914)" \f "Place" }^[162]
Marital Status: Married; Relation to Head of House: Head

Henry D married **Nancy Daily**{ XE "Daily:Nancy (ca.1843–)" \f "Name" \b \i }.^[162–165] They had four sons: Alfred (1867–1928), Harlan (ca.1869–), Howard (1870–1922) and Harry (ca.1876–1937).

Nancy was born in New York{ XE "USA, New York:(42.7531° N, 74.2224° W):Daily, Nancy (ca.1843–)" \f "Place" } about 1843.^[162–164]

- m IV. **Dexter C Sears**{ XE "Sears:Dexter C (1834–1907)" \f "Name" \b } was born in Gouverneur, St Lawrence, New York,{ XE "USA, New York, St Lawrence,

¹⁶² Ancestry.com, 1910 United States Federal Census (Provo, UT, USA, Ancestry.com Operations Inc, 2006), Ancestry.com, Year: 1910; Census Place: Des Moines Ward 1, Polk, Iowa; Roll: T624_419; Page: 5A; Enumeration District: 0090; FHL microfilm: 1374432.

¹⁶³ Ancestry.com., Wisconsin, State Censuses, 1895 and 1905 (Provo, UT, USA, Ancestry.com Operations Inc, 2007), Ancestry.com.

¹⁶⁴ Ancestry.com and The Church of Jesus Christ of Latter-day Saints, 1880 United States Federal Census (Provo, UT, USA, Ancestry.com Operations Inc, 2010), Ancestry.com, Year: 1880; Census Place: Berlin, Green Lake, Wisconsin; Roll: 1428; Family History Film: 1255428; Page: 267A; Enumeration District: 064.

¹⁶⁵ Ancestry.com, Iowa, Select Marriages, 1809–1992 (Provo, UT, USA, Ancestry.com Operations, Inc, 2014), Ancestry.com.

Gouverneur:(44.3367° N, 75.463° W):Sears, Dexter C (1834–1907)" \f "Place" } in April 1834. He died in Stoneham, Middlesex, Massachusetts,{ XE "USA, Massachusetts, Middlesex, Stoneham:(42.4801° N, 71.0995° W):Sears, Dexter C (1834–1907)" \f "Place" } on 6th March 1907, at the age of 72.

Dexter C Sears married **Betty O Scott**{ XE "Scott:Betty O (1844–)" \f "Name" \b \i }. They had four children: Charles (1867–), Walter (1870–1901), Bessie (1879–) and Helen (1883–).

Betty O was born in New York{ XE "USA, New York:(42.7531° N, 74.2224° W):Scott, Betty O (1844–)" \f "Place" } in January 1844.

Family of Laura Sears and William Curtiss{ TC "Laura Sears and William Curtiss" \I 3 \f C}

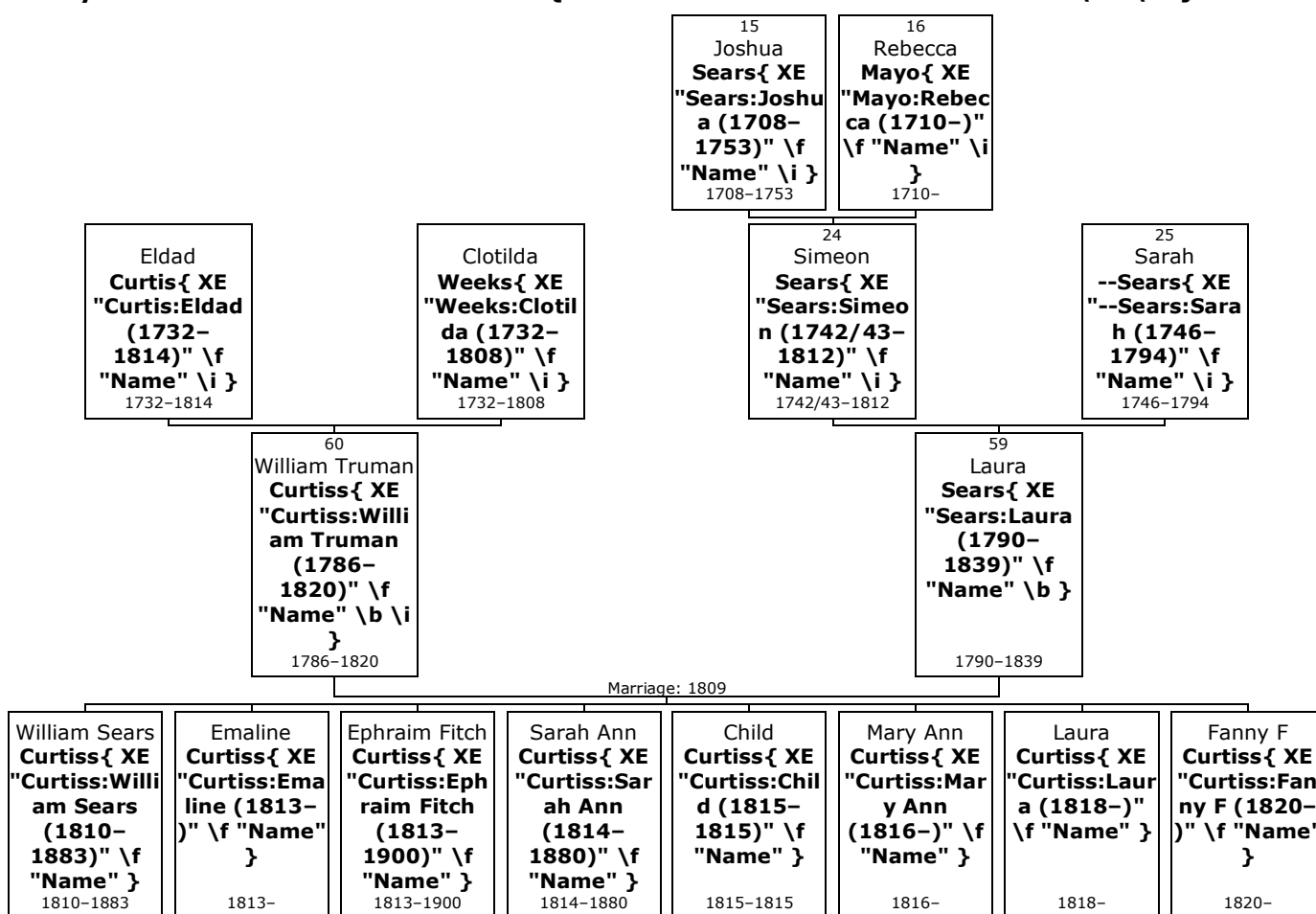

- 59.** **Laura⁴ Sears**{ XE "Sears:Laura (1790–1839)" \f "Name" \b } (*Simeon³, Joshua²*) was born on Wednesday, 24th March 1790, in Pawlet, Rutland, Vermont, USA{ XE "USA, Vermont, Rutland, Pawlet:(43.3467° N, 73.1767° W):Sears, Laura (1790–1839)" \f "Place" }.^[166] She was the daughter of Simeon Sears{ XE "Sears:Simeon (1742/43–1812)" \f "Name" \i } (24) and Sarah --Sears{ XE "--Sears:Sarah (1746–1794)" \f "Name" \i } (25).

Laura died on 6th March 1839, at the age of 48.^[166] She was buried in Avon New Methodist Cemetery, Livingston, New York{ XE "USA, New York, Livingston, Avon New Methodist Cemetery: :Sears, Laura (1790–1839)" \f "Place" }.

RHSecrist

- 60.** At the age of 19, Laura married **William Truman Curtiss**{ XE "Curtiss:William Truman (1786–1820)" \f "Name" \b \i } on Sunday, 29th October 1809, when he was 23 years old.^[166] They had eight children:

¹⁶⁶ "Ancestry Family Tree", Record for Ephraim Fitch CURTISS.
<http://search.ancestry.com/cgi-bin/sse.dll?db=1030&h=13278591617&indiv=try>.

William (1810–1883), Emaline (1813–), Ephraim (1813–1900), Sarah (1814–1880), Child (1815–1815), Mary (1816–), Laura (1818–) and Fanny (1820–).

William Truman was born in Pawlet, Rutland, Vermont, { XE "USA, Vermont, Rutland, Pawlet:(43.3467° N, 73.1767° W):Curtiss, William Truman (1786–1820)" \f "Place" } on Friday, 8th September 1786.^[166] He was the son of Eldad Curtis { XE "Curtis:Eldad (1732–1814)" \f "Name" \i } and Clotilda Weeks { XE "Weeks:Clotilda (1732–1808)" \f "Name" \i }.

William Truman reached 33 years of age and died in 1820.^[166] Lake Erie.

RH Secrist- !Capt, War of 1812, worked for the US Govt. He lived in Salem, NY and then in Western NY. He was lost on Lake Erie about 1820 on a trip to MI.

Children of Laura Sears and William Truman Curtiss:

- m I. **William Sears⁵ Curtiss** { XE "Curtiss:William Sears (1810–1883)" \f "Name" \b } was born in Salem, Washington, New York, { XE "USA, New York, Washington, Salem:(43.1723° N, 73.3276° W):Curtiss, William Sears (1810–1883)" \f "Place" } on 2nd September 1810. He died on 8th April 1883, at the age of 72. William Sears was buried in Lima Cemetery, Avon, Livingston, { XE "USA, New York, Livingston, Avon, Lima Cemetery: :Curtiss, William Sears (1810–1883)" \f "Place" } on 12th April 1883.

At the age of 33, William Sears married **Clarissa Lucinda Pengra** { XE "Pengra:Clarissa Lucinda (1815–)" \f "Name" \b \i } on Sunday, 8th October 1843, in Avon { XE "USA, New York, Livingston, Avon:(42.912° N, 77.7456° W):Curtiss, William Sears (1810–1883)" \f "Place" } when she was 28 years old. They had two children: Helen (1844–1855) and William (1844–).

Clarissa Lucinda was born in Bennington, Vermont, { XE "USA, Vermont, Bennington:(43.0293° N, 73.1084° W):Pengra, Clarissa Lucinda (1815–)" \f "Place" } on Wednesday, 29th March 1815. She was the daughter of William Pengra { XE "Pengra:William" \f "Name" \i } and Belina Calvin { XE "Calvin:Belina" \f "Name" \i }.

William Sears married **Ariminta --Curtis** { XE "--Curtis:Ariminta" \f "Name" \b \i }.

William Sears married **Sarah Elinor Douglass Carter** { XE "Carter:Sarah Elinor Douglass (1831–1908)" \f "Name" \b \i }. They had three children: Clara, Nellie and George.

Sarah Elinor Douglass was born in 1831. She reached 77 years of age and died in 1908.

William Sears married **Bessie Brown** { XE "Brown:Bessie" \f "Name" \b \i }.

- f II. **Emaline Curtiss** { XE "Curtiss:Emaline (1813–)" \f "Name" \b } was born in Pawlet, Rutland, Vermont, { XE "USA, Vermont, Rutland, Pawlet:(43.3467° N, 73.1767° W):Curtiss, Emaline (1813–)" \f "Place" } on 13th February 1813.

- m III. **Ephraim Fitch Curtiss** { XE "Curtiss:Ephraim Fitch (1813–1900)" \f "Name" \b } was born in Pawlet { XE "USA, Vermont, Rutland, Pawlet:(43.3467° N, 73.1767° W):Curtiss, Ephraim Fitch (1813–1900)" \f "Place" } on 13th February 1813.^[166] He died in Geneseo, Livingston, New York, { XE "USA, New York, Livingston, Geneseo:(42.7959° N, 77.817° W):Curtiss, Ephraim Fitch (1813–1900)" \f "Place" } on 23rd January 1900, at the age of 86.^[166] Ephraim Fitch was buried in Temple Hill Cemetery, Geneseo { XE "USA, New York, Livingston, Geneseo, Temple Hill Cemetery: :Curtiss, Ephraim Fitch (1813–1900)" \f "Place" }.

At the age of 28, Ephraim Fitch married **Fidelia F Ashley** { XE "Ashley:Fidelia F (1812–1853)" \f "Name" \b \i } on Tuesday, 16th February 1841, in Bethany, Genesee, { XE "USA, New York, Genesee, Bethany:(42.9087° N, 78.1342° W):Curtiss, Ephraim Fitch (1813–1900)" \f "Place" } when she was 28 years old.^[166] They had four sons: Augustus (1841–1871), Truman (1845–1860), James (1848–1927) and Edward (1857–1881).

Fidelia F was born in Bethany { XE "USA, New York, Genesee, Bethany:(42.9087° N, 78.1342° W):Ashley, Fidelia F (1812–1853)" \f "Place" } on Monday, 12th October 1812.^[166] She was the daughter of Abner Ashley { XE "Ashley:Abner" \f "Name" \i } and Polly Rumsey { XE "Rumsey:Polly" \f "Name" \i }. She was also known as **Clarissa Louise ASHLEY** { XE "ASHLEY:Clarissa Louise (Fidelia F. Ashley) (1812–1853)" \f "Name" }.^[166]

Fidelia F reached 40 years of age and died in Geneseo, Livingston,{ XE "USA, New York, Livingston, Geneseo:(42.7959° N, 77.817° W):Ashley, Fidelia F (1812–1853)" \f "Place" } on 4th April 1853.^[166]

Ephraim Fitch Curtiss married **Clarissa L Ashley**{ XE "Ashley:Clarissa L (-1873)" \f "Name" \b \i } on Saturday, 24th March 1855. They had one son: Ephraim (1862–1944).

Clarissa L died on 27th March 1873.

!RHSecrist-Sister of Ephraim's first wife

- f IV. **Sarah Ann Curtiss**{ XE "Curtiss:Sarah Ann (1814–1880)" \f "Name" \b } was born in Pawlet{ XE "USA, Vermont, Rutland, Pawlet:(43.3467° N, 73.1767° W):Curtiss, Sarah Ann (1814–1880)" \f "Place" } on 5th September 1814. She died in 1880 at the age of 65.

Sarah Ann married **Herbert Smith Rapp**{ XE "Rapp:Herbert Smith (1809–1880)" \f "Name" \b \i }. They had eight children: Emeline (1834–), Ephraim (1836–), Charles (1838–), Curtis (1840–), Laura (1841–), Delia (1843–), Ailene (1847–) and Herbert (1850–1925).

Herbert Smith was born in Warwick, Bucks, Pennsylvania,{ XE "USA, Pennsylvania, Bucks, Warwick:(40.1642° N, 75.7859° W):Rapp, Herbert Smith (1809–1880)" \f "Place" } in 1809. He reached 71 years of age and died in 1880.

!RHSecrist Cabinetmaker, farmer

- f V. **Child Curtiss**{ XE "Curtiss:Child (1815–1815)" \f "Name" \b } was born on 9th August 1815. She died on 9th August 1815.

- f VI. **Mary Ann Curtiss**{ XE "Curtiss:Mary Ann (1816–)" \f "Name" \b } was born on 8th October 1816.

- f VII. **Laura Curtiss**{ XE "Curtiss:Laura (1818–)" \f "Name" \b } was born on 25th November 1818.

Laura married **Jackson Rapp**{ XE "Rapp:Jackson" \f "Name" \b \i }.

- f VIII. **Fanny F Curtiss**{ XE "Curtiss:Fanny F (1820–)" \f "Name" \b } was born on 20th October 1820.

Family of Ebenezer Hitchcock and Elizabeth Everett{ TC "Ebenezer Hitchcock and Elizabeth Everett" \I 3 \f C}

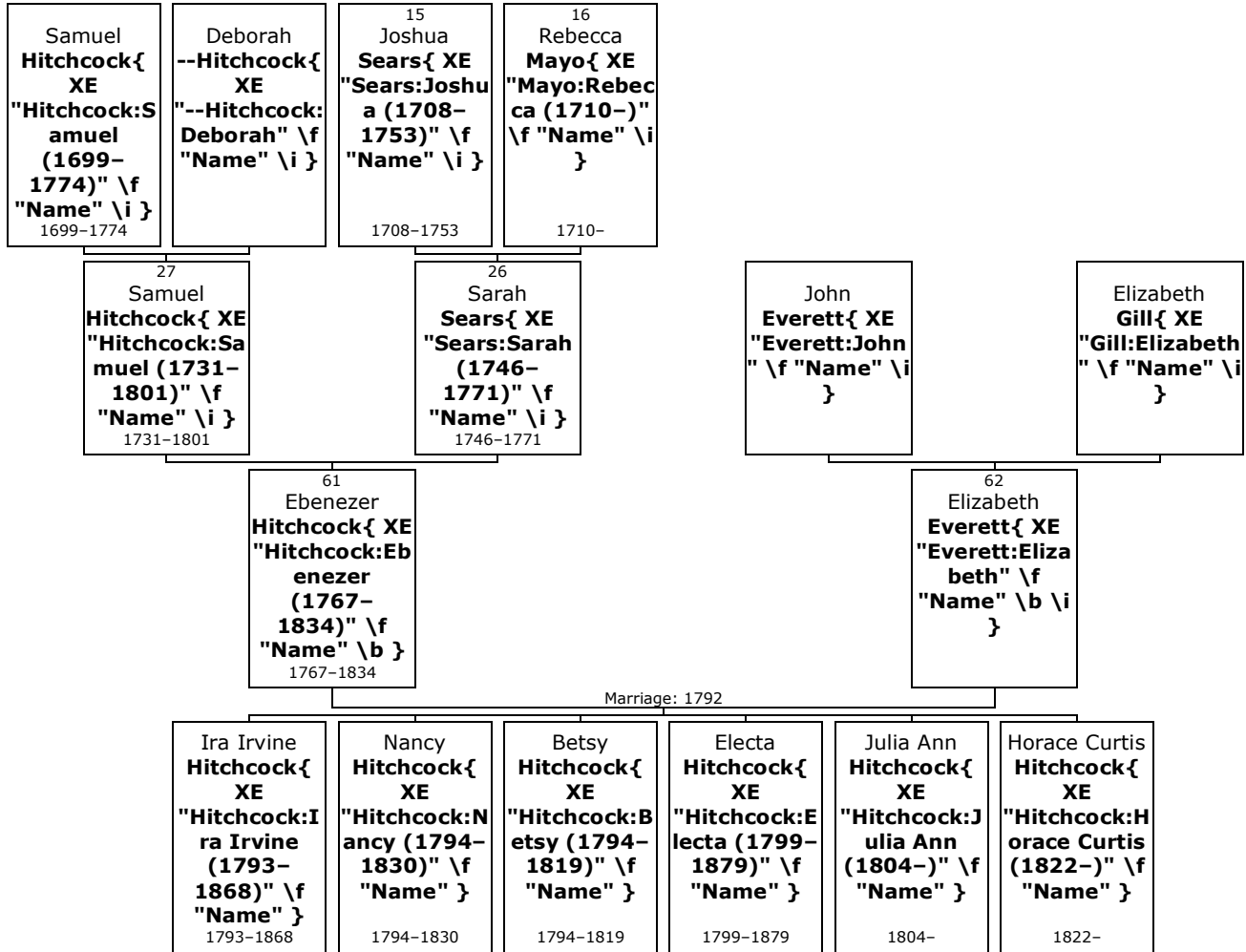

61. **Ebenezer⁴ Hitchcock**{ XE "Hitchcock:Ebenezer (1767-1834)" \f "Name" \b } (*Sarah³ Sears, Joshua²*) was born on Monday, 23rd November 1767, in Marlborough, Middlesex, Massachusetts, USA{ XE "USA, Massachusetts, Middlesex, Marlborough:(42.3459° N, 71.5523° W):Hitchcock, Ebenezer (1767-1834)" \f "Place" }. He was the son of Samuel Hitchcock{ XE "Hitchcock:Samuel (1731-1801)" \f "Name" \i } (27) and Sarah Sears{ XE "Sears:Sarah (1746-1771)" \f "Name" \i } (26).

Ebenezer died in Frankfort, Herkimer, New York,{ XE "USA, New York, Herkimer, Frankfort:(43.039° N, 75.0704° W):Hitchcock, Ebenezer (1767-1834)" \f "Place" } on 19th April 1834, at the age of 66.

62. Ebenezer married **Elizabeth Everett**{ XE "Everett:Elizabeth" \f "Name" \b \i } on Tuesday, 23rd October 1792. They had six children: Ira (1793-1868), Nancy (1794-1830), Betsy (1794-1819), Electa (1799-1879), Julia (1804-) and Horace (1822-). She was the daughter of John Everett{ XE "Everett:John" \f "Name" \i } and Elizabeth Gill{ XE "Gill:Elizabeth" \f "Name" \i }.

Children of Ebenezer Hitchcock and Elizabeth Everett:

- m I. **Ira Irvine⁵ Hitchcock**{ XE "Hitchcock:Ira Irvine (1793-1868)" \f "Name" \b } was born in Litchfield Twp{ XE "USA, New York, Herkimer, Litchfield Twp:(42.9776° N, 75.1507° W):Hitchcock, Ira Irvine (1793-1868)" \f "Place" } on 11th February 1793. He died in Philadelphia, Pennsylvania,{ XE "USA, Pennsylvania, Philadelphia:(40.0068° N, 75.1347° W):Hitchcock, Ira Irvine (1793-1868)" \f "Place" } on 1st December 1868, at the age of 75.
Ira Irvine married **Melinda Bishop**{ XE "Bishop:Melinda" \f "Name" \b \i }.
- f II. **Nancy Hitchcock**{ XE "Hitchcock:Nancy (1794-1830)" \f "Name" \b } was born on 19th November 1794. She died on 10th June 1830, at the age of 35.
Nancy married **Adin Breed**{ XE "Breed:Adin" \f "Name" \b \i }.

- f III. **Betsy Hitchcock**{ XE "Hitchcock:Betsy (1794–1819)" \f "Name" \b } was born in Litchfield Twp{ XE "USA, New York, Herkimer, Litchfield Twp:(42.9776° N, 75.1507° W):Hitchcock, Betsy (1794–1819)" \f "Place" } on 19th November 1794. She died on 5th March 1819, at the age of 24.
- f IV. **Electa Hitchcock**{ XE "Hitchcock:Electa (1799–1879)" \f "Name" \b } was born in Litchfield Twp{ XE "USA, New York, Herkimer, Litchfield Twp:(42.9776° N, 75.1507° W):Hitchcock, Electa (1799–1879)" \f "Place" } on 12th April 1799. She died in 1879 at the age of 79.
Electa married **John Rector**{ XE "Rector:John" \f "Name" \b \i }.
- f V. **Julia Ann Hitchcock**{ XE "Hitchcock:Julia Ann (1804–)" \f "Name" \b } was born in Litchfield Twp{ XE "USA, New York, Herkimer, Litchfield Twp:(42.9776° N, 75.1507° W):Hitchcock, Julia Ann (1804–)" \f "Place" } on 6th February 1804.
Julia Ann married **Alin Breed**{ XE "Breed:Alin" \f "Name" \b \i }.
- m VI. **Horace Curtis Hitchcock**{ XE "Hitchcock:Horace Curtis (1822–)" \f "Name" \b } was born in Paris, Oneida,{ XE "USA, New York, Oneida, Paris:(43.0006° N, 75.3142° W):Hitchcock, Horace Curtis (1822–)" \f "Place" } on 26th December 1822.
Horace Curtis married **Almira Wood**{ XE "Wood:Almira" \f "Name" \b \i }.

Family of Reuben Hitchcock and Electa Spaulding{ TC "Reuben Hitchcock and Electa Spaulding" \I 3 \f C }

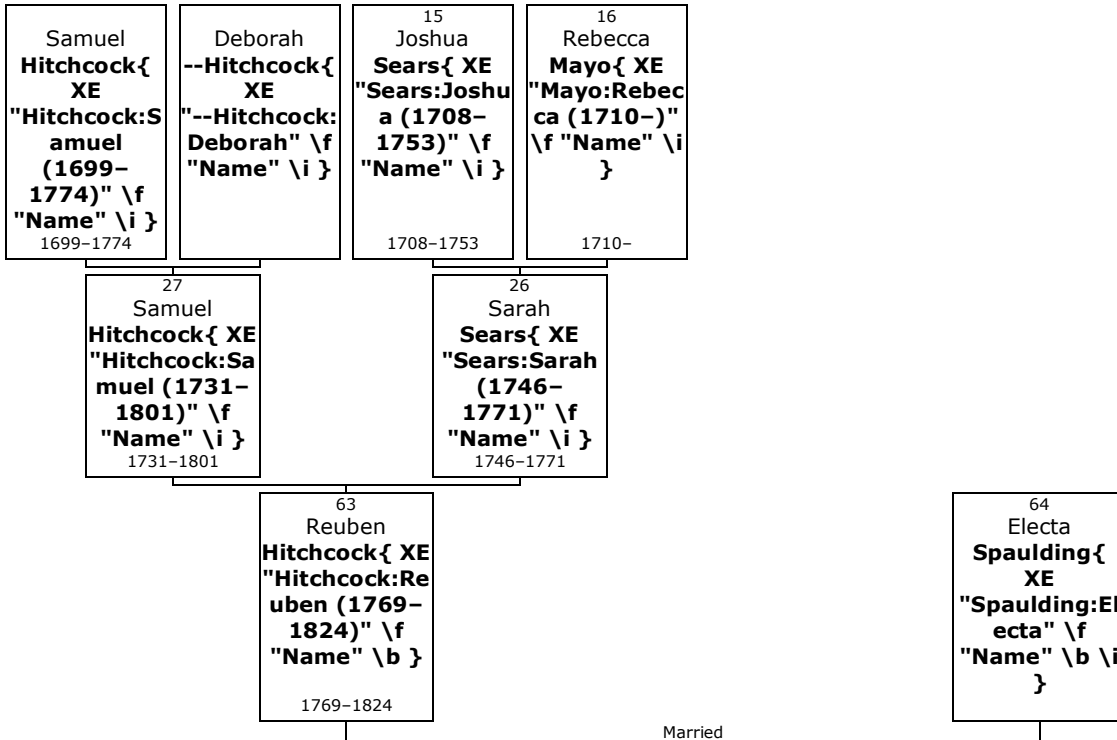

- 63. **Reuben⁴ Hitchcock**{ XE "Hitchcock:Reuben (1769–1824)" \f "Name" \b } (*Sarah³ Sears, Joshua²*) was born in 1769 in New Marlborough, Berkshire, Massachusetts, USA{ XE "USA, Massachusetts, Berkshire, New Marlborough:(42.1229° N, 73.2287° W):Hitchcock, Reuben (1769–1824)" \f "Place" }. He was the son of Samuel Hitchcock{ XE "Hitchcock:Samuel (1731–1801)" \f "Name" \i } (27) and Sarah Sears{ XE "Sears:Sarah (1746–1771)" \f "Name" \i } (26).
Reuben died in Vernon, Oneida, New York,{ XE "USA, New York, Oneida, Vernon:(43.0795° N, 75.5393° W):Hitchcock, Reuben (1769–1824)" \f "Place" } on 4th April 1824, at the age of 55.
- 64. He married **Electa Spaulding**{ XE "Spaulding:Electa" \f "Name" \b \i }.

Family of Jerusha Hitchcock and David Rhodes{ TC "Jerusha Hitchcock and David Rhodes" \I 3 \f C}

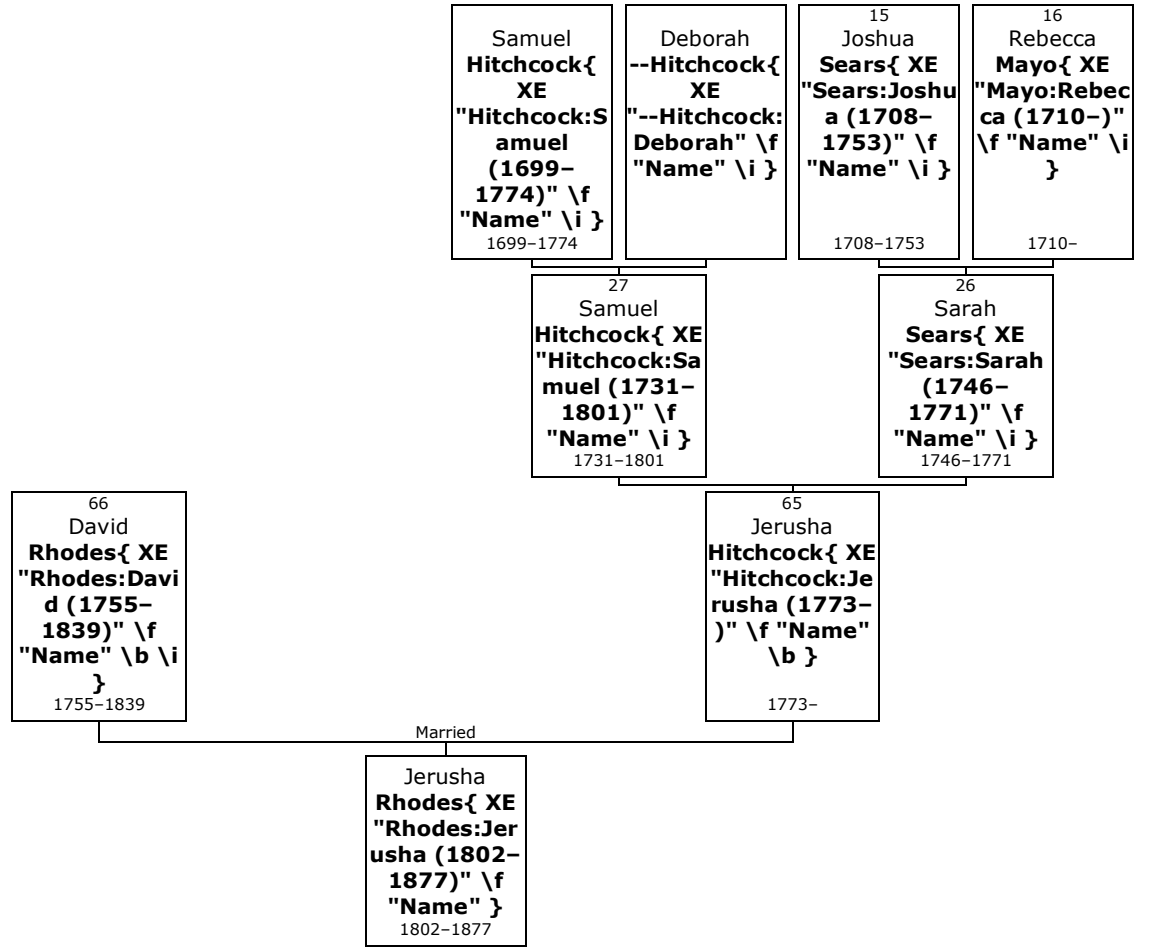

65. Jerusha⁴ Hitchcock{ XE "Hitchcock:Jerusha (1773-)" \f "Name" \b } (Sarah³ Sears, Joshua²) was born in 1773 in New Marlborough, Berkshire, Massachusetts, USA{ XE "USA, Massachusetts, Berkshire, New Marlborough:(42.1229° N, 73.2287° W):Hitchcock, Jerusha (1773-)" \f "Place" }.^[167] She was the daughter of Samuel Hitchcock{ XE "Hitchcock:Samuel (1731-1801)" \f "Name" \i } (27) and Sarah Sears{ XE "Sears:Sarah (1746-1771)" \f "Name" \i } (26).

Jerusha died in Ovid, Seneca, New York{ XE "USA, New York, Seneca, Ovid:(42.6765° N, 76.823° W):Hitchcock, Jerusha (1773-)" \f "Place" }.

!NY (DAR info says she was daughter of Deborah Mallory and Samuel Hitchcock) = 1801 David Rhodes 1755 d 1839 Cayuga Co NY (Jerusha was his second wife) David Rhodes enlisted from Stoughan, MA as a private 1775 and was in the Battle of Trenton. Received a pension for his service at Cayuga Co NY. (DAR 37740)

66. She married David Rhodes{ XE "Rhodes:David (1755-1839)" \f "Name" \b \i }. They had one daughter: Jerusha (1802-1877).

David was born in 1755. He reached 84 years of age and died in Cayuga{ XE "USA, New York, Cayuga:(42.9448° N, 76.5614° W):Rhodes, David (1755-1839)" \f "Place" } in 1839.

Daughter of Jerusha Hitchcock and David Rhodes:

f I. **Jerusha⁵ Rhodes{ XE "Rhodes:Jerusha (1802-1877)" \f "Name" \b }** was born in 1802. She died in 1877 at the age of 75.

Jerusha married **Roswell Lane{ XE "Lane:Roswell (1778-1870)" \f "Name" \b \i }** in 1820. They had one daughter: Sarah (1826-1890).

¹⁶⁷ Ancestry.com, U.S., Sons of the American Revolution Membership Applications, 1889-1970 (Provo, UT, USA, Ancestry.com Operations, Inc., 2011), Ancestry.com, Volume: 287. [Source citation includes one media item]

Roswell was born in 1778. He reached 92 years of age and died in 1870.

Nephews/nieces{ TC "Nephews/nieces" \I 2 \f C}

Family of Sarah Sears and Wheeler{ TC "Sarah Sears and Wheeler" \I 3 \f C}

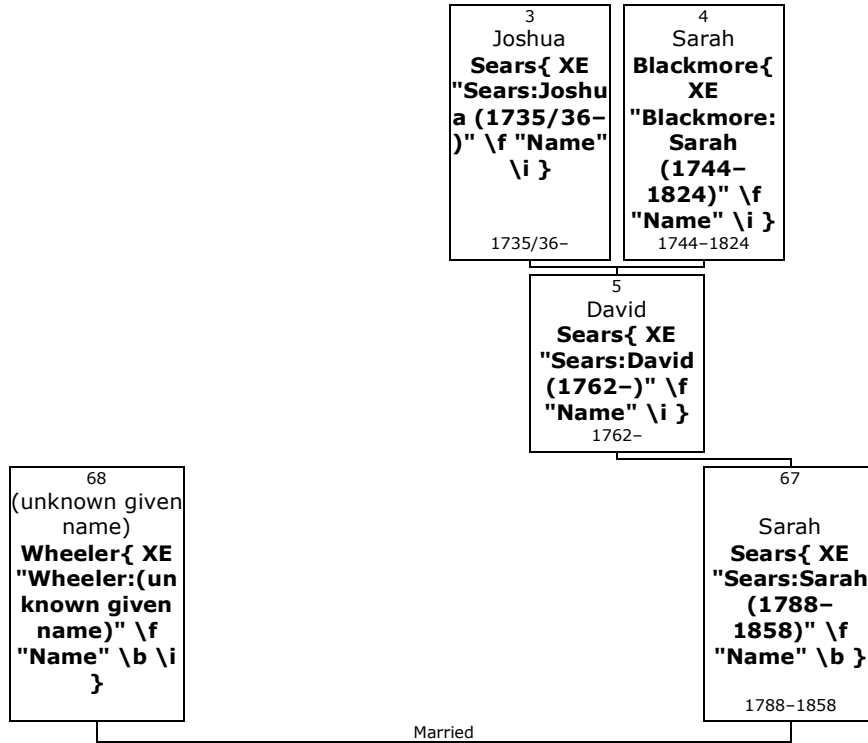

67. **Sarah⁵ Sears**{ XE "Sears:Sarah (1788-1858)" \f "Name" \b } (*David⁴, Sarah³ Blackmore*) was born in 1788 in Sandisfield, Berkshire, Massachusetts, USA{ XE "USA, Massachusetts, Berkshire, Sandisfield:(42.1126° N, 73.1432° W):Sears, Sarah (1788-1858)" \f "Place" }. She was the daughter of David Sears{ XE "Sears:David (1762-)" \f "Name" \i } (5).

Sarah died in 1858 at the age of 70.

!S P May No 1232 p.226 Removed to NY state

68. She married **(unknown given name) Wheeler**{ XE "Wheeler:(unknown given name)" \f "Name" \b \i }.

Mary Sears{ TC "Mary Sears" \I 3 \f C}

69. **Mary⁵ Sears**{ XE "Sears:Mary (1790-1860)" \f "Name" \b } (*David⁴, Sarah³ Blackmore*) was born in 1790 in Sandisfield, Berkshire, Massachusetts, USA{ XE "USA, Massachusetts, Berkshire, Sandisfield:(42.1126° N, 73.1432° W):Sears, Mary (1790-1860)" \f "Place" }. She was the daughter of David Sears{ XE "Sears:David (1762-)" \f "Name" \i } (5).

Mary died in 1860 at the age of 70.

S P May No 1233

Marriages with Isaac Gamble and Immar Hubbard (Page 115) are known.

Family of Mary Sears and Isaac Gamble{ TC "Mary Sears and Isaac Gamble" \I 4 \f C}

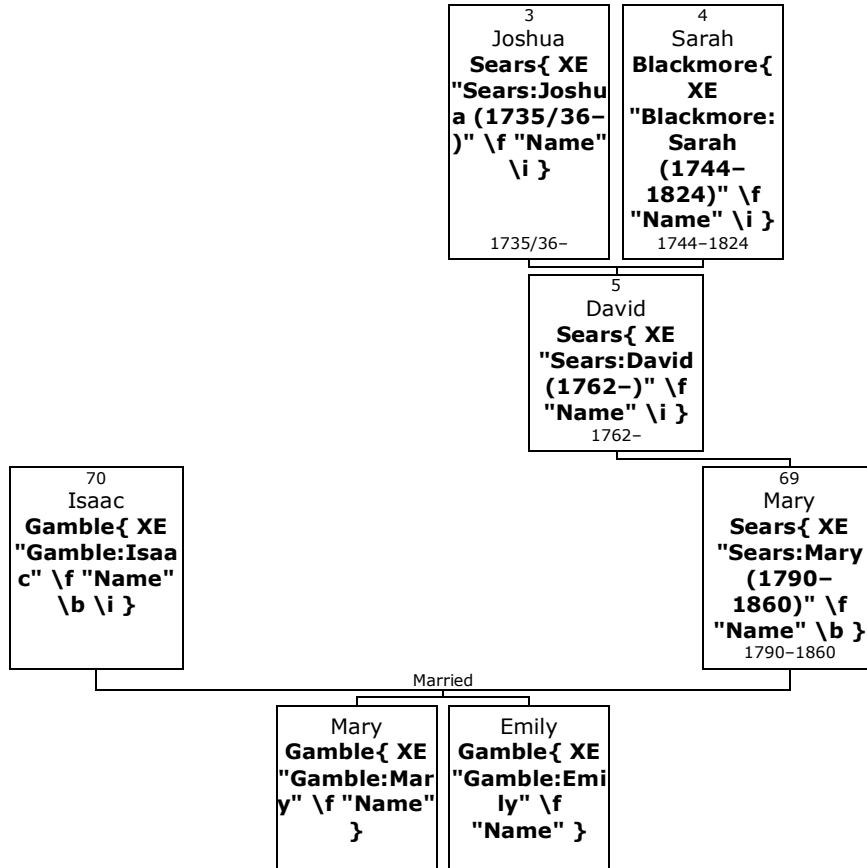

Here are the details about **Mary Sears**{ XE "Sears:Mary (1790–1860)" \f "Name" \b } first marriage, with Isaac Gamble. You can read more about Mary on page 113.

70. Mary Sears married **Isaac Gamble**{ XE "Gamble:Isaac" \f "Name" \b \i }. They had two daughters: Mary and Emily.

Daughters of Mary Sears and Isaac Gamble:

- f I. **Mary⁶ Gamble**{ XE "Gamble:Mary" \f "Name" \b }.
- f II. **Emily Gamble**{ XE "Gamble:Emily" \f "Name" \b }.

Family of Mary Sears and Immar Hubbard{ TC "Mary Sears and Immar Hubbard" \I 4 \f C}

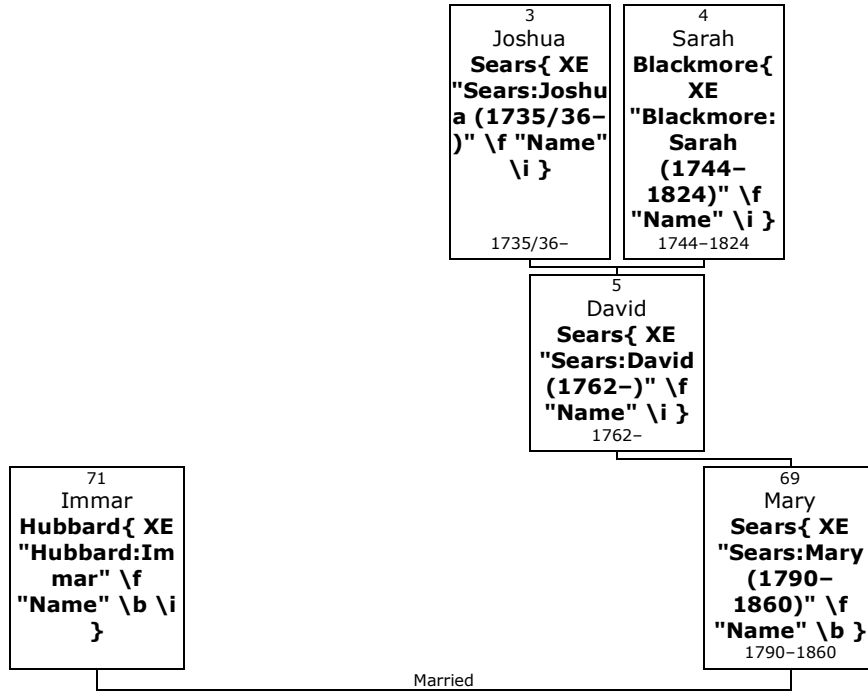

Here are the details about **Mary Sears**{ XE "Sears:Mary (1790-1860)" \f "Name" \b } second marriage, with Immar Hubbard. You can read more about Mary on page 113.

- 71.** Mary married **Immar Hubbard**{ XE "Hubbard:Immar" \f "Name" \b \i }.

Family of Sarah Sears and Baldwin{ TC "Sarah Sears and Baldwin" \I 3 \f C}

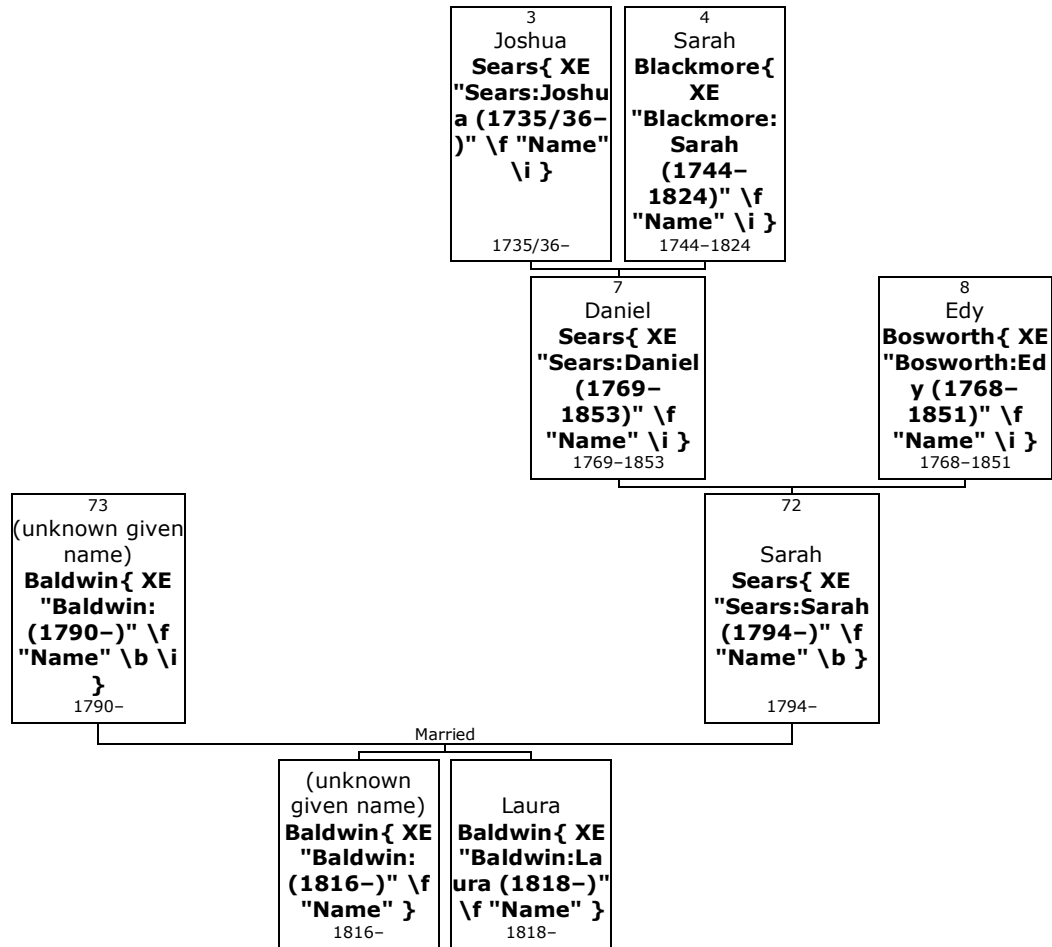

- 72.** **Sarah⁵ Sears**{ XE "Sears:Sarah (1794-)" \f "Name" \b } (*Capt Daniel⁴, Sarah³ Blackmore*) was born on Sunday, 12th January 1794, in Sandisfield, Berkshire, Massachusetts, USA{ XE "USA, Massachusetts, Berkshire, Sandisfield:(42.1126° N, 73.1432° W):Sears, Sarah (1794-)" \f "Place" }. She was the daughter of Daniel Sears{ XE "Sears:Daniel (1769-1853)" \f "Name" \i } (7) and Edy Bosworth{ XE "Bosworth:Edy (1768-1851)" \f "Name" \i } (8).

!S P May No 1237 p.228 Mrs Baldwin lives in gates Mills, Cuyahoga co., OH, with her gr-children; address, care Albert Shepard

<https://www.wikitree.com/wiki/Sears-5182>

- 73.** She married **(unknown given name) Baldwin**{ XE "Baldwin: (1790-)" \f "Name" \b \i }. They had two children: (unknown given name) (1816-) and Laura (1818-).

(unknown given name) was born in Goshen, Litchfield, Connecticut,{ XE "USA, Connecticut, Litchfield, Goshen:(41.8317° N, 73.2256° W):Baldwin, (1790-)" \f "Place" } in 1790.

Children of Sarah Sears and (unknown given name) Baldwin:

- m I. **(unknown given name)⁶ Baldwin**{ XE "Baldwin: (1816-)" \f "Name" \b } was born in perh, Sandisfield, Berkshire, Massachusetts,{ XE "USA, Massachusetts, Berkshire, Sandisfield, perh: :Baldwin, (1816-)" \f "Place" } in 1816.
- f II. **Laura Baldwin**{ XE "Baldwin:Laura (1818-)" \f "Name" \b } was born in perh{ XE "USA, Massachusetts, Berkshire, Sandisfield, perh: :Baldwin, Laura (1818-)" \f "Place" } in 1818.
- Laura married **James Shepard**{ XE "Shepard:James" \f "Name" \b \i }.

Family of Jason Sears and Martha Anthony{ TC "Jason Sears and Martha Anthony" \I 3 \f C}

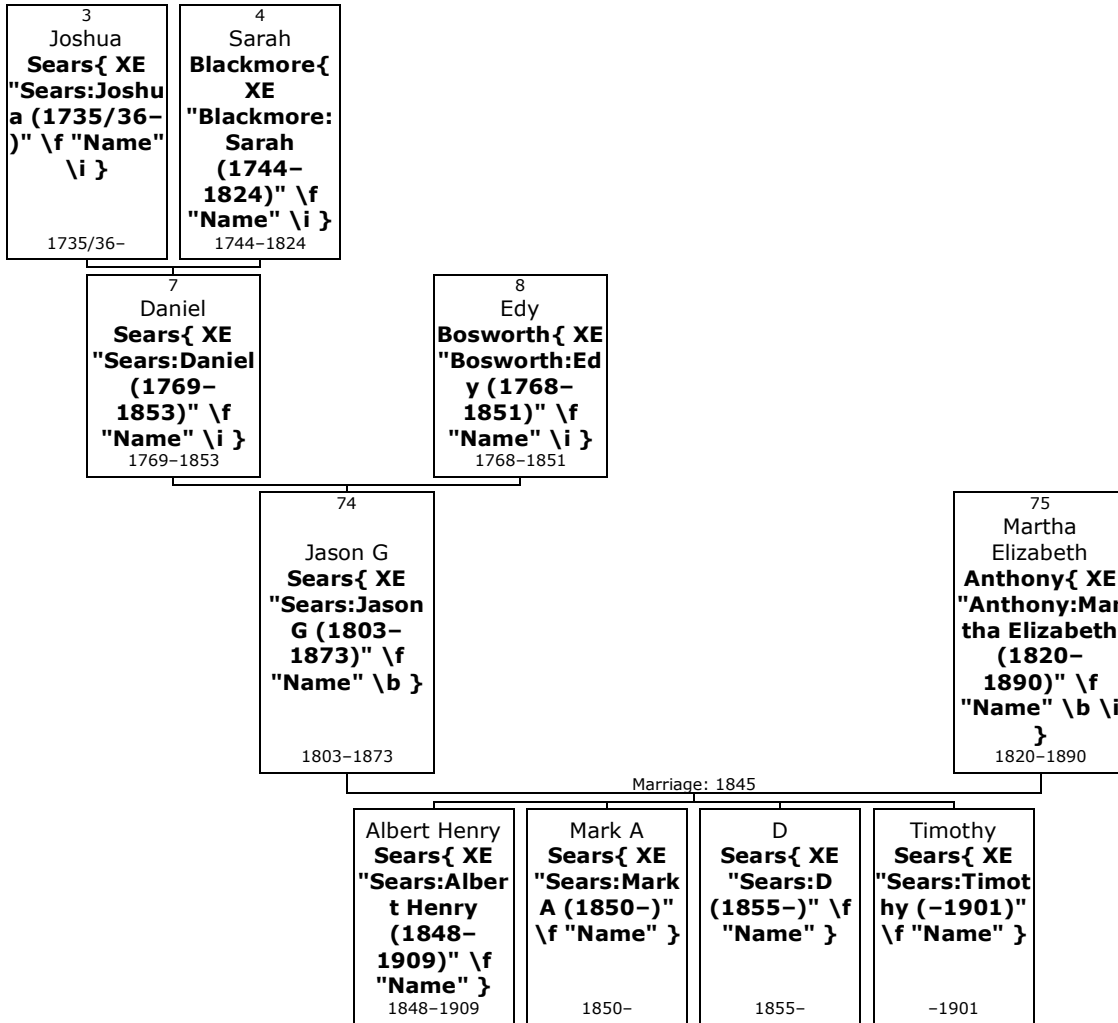

74. **Jason G⁵ Sears**{ XE "Sears:Jason G (1803-1873)" \f "Name" \b } (*Capt Daniel⁴, Sarah³ Blackmore*) was born on Monday, 28th February 1803, in Sandisfield, Berkshire, Massachusetts, USA{ XE "USA, Massachusetts, Berkshire, Sandisfield:(42.1126° N, 73.1432° W):Sears, Jason G (1803-1873)" \f "Place" }.^[168, 169, 170, 171-172] was 29 Feb? He was the son of Daniel Sears{ XE "Sears:Daniel (1769-1853)" \f "Name" \i } (7) and Edy Bosworth{ XE "Bosworth:Edy (1768-1851)" \f "Name" \i } (8).

Jason G died in Clinton{ XE "USA, Alabama, Greene, Clinton:(32.9136° N, 87.9925° W):Sears, Jason G (1803-1873)" \f "Place" } on 25th January 1873, at the age of 69.^[168] He was buried in Clinton{ XE "USA, Alabama, Greene, Clinton:(32.9136° N, 87.9925° W):Sears, Jason G (1803-1873)" \f "Place" }.^[168]

¹⁶⁸ Ancestry.com, U.S., Find A Grave Index, 1600s-Current (Provo, UT, USA, Ancestry.com Operations, Inc., 2012), Ancestry.com.

¹⁶⁹ Ancestry.com, Massachusetts, Town and Vital Records, 1620-1988 (Provo, UT, USA, Ancestry.com Operations, Inc., 2011), Ancestry.com.
[Source citation includes one media item]

¹⁷⁰ Ancestry.com, 1870 United States Federal Census (Provo, UT, USA, Ancestry.com Operations, Inc., 2009), Ancestry.com, Year: 1870; Census Place: Clinton, Greene, Alabama; Roll: M593_17; Page: 631A; Image: 370770; Family History Library Film: 545516.
[Source citation includes one media item]

¹⁷¹ Ancestry.com, 1850 United States Federal Census (Provo, UT, USA, Ancestry.com Operations, Inc., 2009), Ancestry.com, Year: 1850; Census Place: Clinton, Greene, Alabama; Roll: M432_6; Page: 270A; Image: 58.
[Source citation includes one media item]

¹⁷² Ancestry.com, Alabama, Select Marriages, 1816-1942 (Provo, UT, USA, Ancestry.com Operations, Inc, 2014), Ancestry.com.

!S.P.May No 1239 p.368 Jason Sears was a merchant in Alabama; married a southern lady, by whom he became the owner of several slaves; accumulated considerable property but lost largely by the Rebellion.

<https://www.wikitree.com/wiki/Sears-5184>

1850 Census Name: Jason G Sears Age: 46 merchant Estimated birth year: abt 1804 Birth place: Massachusetts Gender: Male Home in 1850 (City,County,State): Clinton, Greene, Alabama enum w/ wife and sons Albert and Mark

1860 Census Name: J G Sears Age in 1860: 56 Birthplace: Massachusetts Home in 1860: Clinton, Greene, Alabama Gender: Male Head of Household: J G Sears Post Office: Clinton enum w/ wife, A Sears, M A Sears, D Sears ae 5

1870 Census Name: Jason G Sears Estimated Birth Year: abt 1804 Age in 1870: 66 Birthplace: Massachusetts Home in 1870: Clinton, Greene, Alabama Race: White Gender: Male Post Office: Clinton enum w/ wife

More facts and events for Jason G Sears:

Residence: 1850 Clinton{ XE "USA, Alabama, Greene, Clinton:(32.9136° N, 87.9925° W):Sears, Jason G (1803–1873)" \f "Place" }^[171]

Residence: 1870 Clinton{ XE "USA, Alabama, Greene, Clinton:(32.9136° N, 87.9925° W):Sears, Jason G (1803–1873)" \f "Place" }^[170]
Post Office: Clinton

- 75.** Jason G married **Martha Elizabeth Anthony**{ XE "Anthony:Martha Elizabeth (1820–1890)" \f "Name" \b \i } on Saturday, 29th November 1845, in Tuscaloosa{ XE "USA, Alabama, Tuscaloosa:(33.2879° N, 87.5238° W):Sears, Jason G (1803–1873)" \f "Place" }.^[171, 172] They had four sons: Albert (1848–1909), Mark (1850–), D (1855–) and Timothy (–1901).

Martha Elizabeth was born in Georgia{ XE "USA, Georgia:(32.7583° N, 82.5584° W):Anthony, Martha Elizabeth (1820–1890)" \f "Place" } in 1820.^[171] She reached 70 years of age and died in 1890.

Timothy is born too soon, she would be 11?

More facts and events for Martha Elizabeth Anthony:

Residence: 1850 Clinton{ XE "USA, Alabama, Greene, Clinton:(32.9136° N, 87.9925° W):Anthony, Martha Elizabeth (1820–1890)" \f "Place" }^[171]

Sons of Jason G Sears and Martha Elizabeth Anthony:

- m I. **Albert Henry⁶ Sears**{ XE "Sears:Albert Henry (1848–1909)" \f "Name" \b } was born in Greene{ XE "USA, Alabama, Greene:(32.8548° N, 87.9513° W):Sears, Albert Henry (1848–1909)" \f "Place" } on 28th August 1848.^[171, 173, 174–175] He died in Covington{ XE "USA, Mississippi, Covington:(31.632° N, 89.5519° W):Sears, Albert Henry (1848–1909)" \f "Place" } on 28th December 1909, at the age of 61.^[175] Albert Henry was buried in Covington{ XE "USA, Mississippi, Covington:(31.632° N, 89.5519° W):Sears, Albert Henry (1848–1909)" \f "Place" }.^[175]

More facts and events for Albert Henry Sears:

Residence: 1850 Clinton, Greene, Alabama{ XE "USA, Alabama, Greene, Clinton:(32.9136° N, 87.9925° W):Sears, Albert Henry

¹⁷³ Ancestry.com and The Church of Jesus Christ of Latter-day Saints, 1880 United States Federal Census (Provo, UT, USA, Ancestry.com Operations Inc, 2010), Ancestry.com, Year: 1880; Census Place: Clinton, Greene, Alabama; Roll: 14; Family History Film: 1254014; Page: 63B; Enumeration District: 077; Image: 0129.

¹⁷⁴ Ancestry.com, 1900 United States Federal Census (Provo, UT, USA, Ancestry.com Operations Inc, 2004), Ancestry.com, Year: 1900; Census Place: Missionary, Jasper, Mississippi; Roll: 812; Page: 5B; Enumeration District: 0048; FHL microfilm: 1240812.

¹⁷⁵ Ancestry.com, U.S., Find A Grave Index, 1600s-Current (Provo, UT, USA, Ancestry.com Operations, Inc., 2012), Ancestry.com, Record for Albert Henry Sears.
<http://search.ancestry.com/cgi-bin/sse.dll?db=60525&h=47823945&indiv=try>.

- (1848–1909)" \f "Place" }^[171]
- Residence: 1880 Clinton{ XE "USA, Alabama, Greene, Clinton:(32.9136° N, 87.9925° W):Sears, Albert Henry (1848–1909)" \f "Place" }^[173]
 Marital status: Married; Relation to Head of House: Self
- Residence: 1900 Missionary, Jasper, Mississippi{ XE "USA, Mississippi, Jasper, Missionary: :Sears, Albert Henry (1848–1909)" \f "Place" }^[174]
 Marital Status: Married; Relation to Head of House: Head

Albert Henry married **Florida Martha Sanders**{ XE "Sanders:Florida Martha (ca.1850–)" \f "Name" \b \i } on Thursday, 14th October 1869, in Greene, Alabama{ XE "USA, Alabama, Greene:(32.8548° N, 87.9513° W):Sears, Albert Henry (1848–1909)" \f "Place" }.^[172, 173] They had five children: Milla (ca.1869–), Mattie (1872–1940), Jason (1873–1942), Kittie (1876–1953) and Henry (1878–1937).

Florida Martha was born in Georgia{ XE "USA, Georgia:(32.7583° N, 82.5584° W):Sanders, Florida Martha (ca.1850–)" \f "Place" } about 1850.^[173]

Albert Henry Sears married **Julia A Peatock**{ XE "Peatock:Julia A (1851–1934)" \f "Name" \b \i } in 1896.^[174] They had two children: Florida (1888–) and Albert (1890–).

Julia A was born in Mississippi{ XE "USA, Mississippi:(32.6083° N, 89.1° W):Peatock, Julia A (1851–1934)" \f "Place" } on Tuesday, 25th February 1851.^[174] She reached 83 years of age and died in Ora, Covington,{ XE "USA, Mississippi, Covington, Ora:(31.6577° N, 89.5745° W):Peatock, Julia A (1851–1934)" \f "Place" } on 26th June 1934.

- m II. **Mark A Sears**{ XE "Sears:Mark A (1850–)" \f "Name" \b } was born in Alabama{ XE "USA, Alabama:(32.7665° N, 86.8403° W):Sears, Mark A (1850–)" \f "Place" } in May 1850.^[171]

More facts and events for Mark A Sears:

Residence: 1850 Clinton{ XE "USA, Alabama, Greene, Clinton:(32.9136° N, 87.9925° W):Sears, Mark A (1850–)" \f "Place" }^[171]

- m III. **D Sears**{ XE "Sears:D (1855–)" \f "Name" \b } was born in Alabama{ XE "USA, Alabama:(32.7665° N, 86.8403° W):Sears, D (1855–)" \f "Place" } in 1855.
- m IV. **Timothy Sears**{ XE "Sears:Timothy (-1901)" \f "Name" \b }. He died in 1901.

Family of Henry Sears and Mary Wheeler{ TC "Henry Sears and Mary Wheeler" \I 3 \f C}

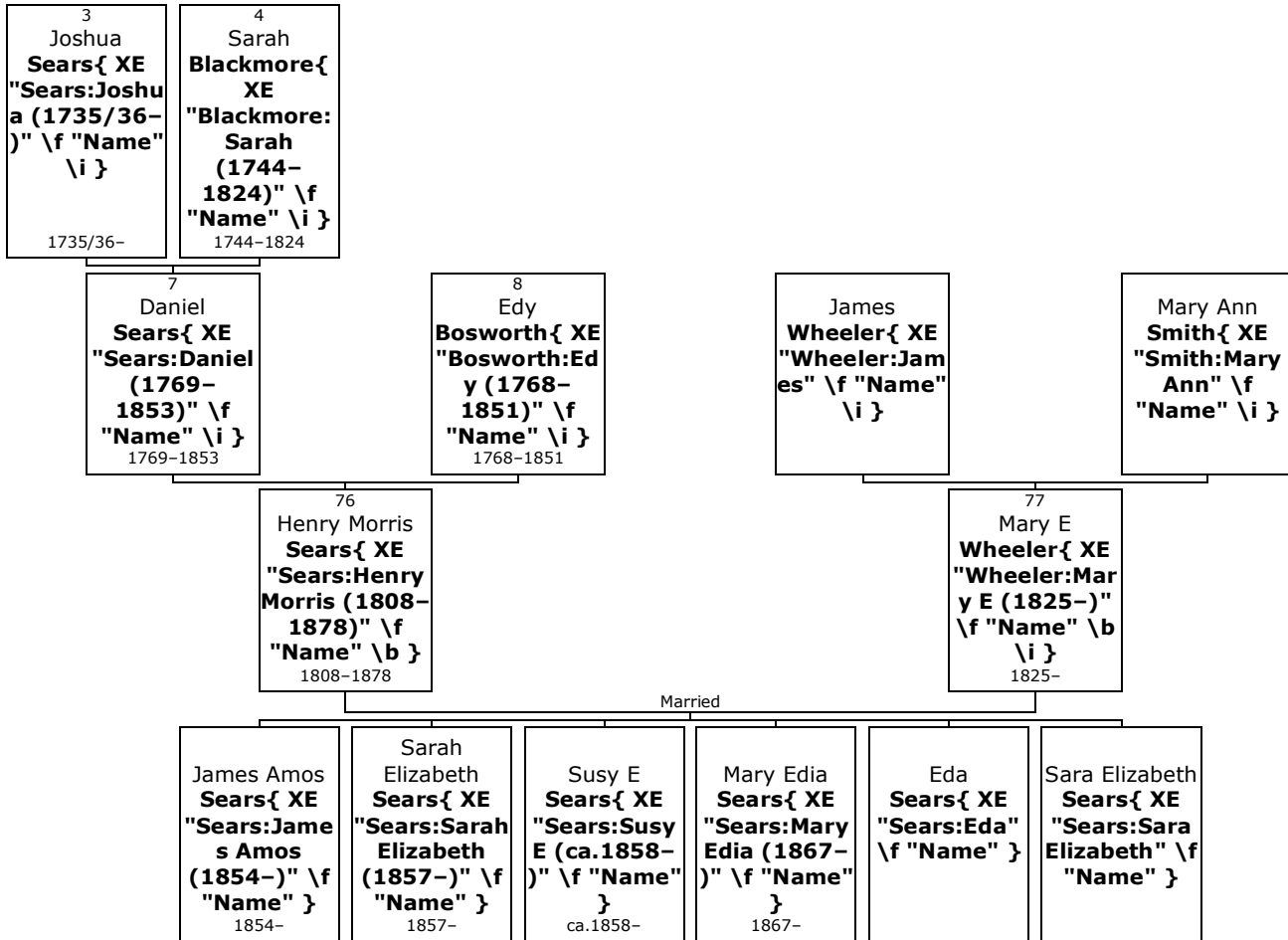

- 76. Henry Morris⁵ Sears**{ XE "Sears:Henry Morris (1808-1878)" \f "Name" \b } (*Capt Daniel⁴, Sarah³ Blackmore*) was born on Thursday, 10th March 1808, in Sandisfield, Berkshire, Massachusetts, USA{ XE "USA, Massachusetts, Berkshire, Sandisfield:(42.1126° N, 73.1432° W):Sears, Henry Morris (1808-1878)" \f "Place" \i }.^[176, 177, 178, 179, 180-181] He was the son of Daniel Sears{ XE "Sears:Daniel (1769-1853)" \f "Name" \i } (7) and Edy Bosworth{ XE "Bosworth:Edy (1768-1851)" \f "Name" \i } (8).

¹⁷⁶ Ancestry.com, Massachusetts, Town and Vital Records, 1620-1988 (Provo, UT, USA, Ancestry.com Operations, Inc., 2011), Ancestry.com.

[Source citation includes one media item]

¹⁷⁷ Ancestry.com, 1860 United States Federal Census (Provo, UT, USA, Ancestry.com Operations, Inc., 2009), Ancestry.com, Year: 1860; Census Place: Sandisfield, Berkshire, Massachusetts; Roll: M653_487; Page: 745; Family History Library Film: 803487.

[Source citation includes one media item]

¹⁷⁸ Ancestry.com and The Church of Jesus Christ of Latter-day Saints, 1880 United States Federal Census (Provo, UT, USA, Ancestry.com Operations Inc, 2010), Ancestry.com, Year: 1880; Census Place: Veteran, Chemung, New York; Roll: 817; Page: 590C; Enumeration District: 088. Record for Sarah E. Sears.

<http://search.ancestry.com/cgi-bin/sse.dll?db=6742&h=1460947&indiv=try>.

[Source citation includes one media item]

¹⁷⁹ Ancestry.com, Massachusetts, Town and Vital Records, 1620-1988 (Provo, UT, USA, Ancestry.com Operations, Inc., 2011), Ancestry.com, Record for Henry Morris Sears. <http://search.ancestry.com/cgi-bin/sse.dll?db=2495&h=4816287&indiv=try>.

[Source citation includes one media item]

¹⁸⁰ Ancestry.com, New York, State Census, 1865 (Provo, UT, USA, Ancestry.com Operations, Inc., 2014), Ancestry.com, Record for Henry M Sears. <http://search.ancestry.com/cgi-bin/sse.dll?db=7218&h=1084737&indiv=try>.

[Source citation includes one media item]

¹⁸¹ National Society, Daughters of the American Revolution, Daughters of the American Revolution Lineage Books (152 Vols.) (Provo, UT, USA, Ancestry.com Operations, Inc., 2000), Ancestry.com, Record for Henry M. Sears.

<http://search.ancestry.com/cgi-bin/sse.dll?db=3174&h=600046321&indiv=try>.

Henry Morris died in 1878 at the age of 69.

!S.P. May No 1241 p.368 Henry Sears removed to New York State

<https://www.wikitree.com/wiki/Sears-5186>

!

!1860 Census Name: Henry M Sears Age in 1860: 52 Birthplace: Massachusetts Home in 1860: Sandisfield, Berkshire, Massachusetts Gender: Male Head of Household: Henry M Sears Post Office: Sandisfield enum w/ wife and 2 children

!

!1870 Census Name: Henry Sears Estimated Birth Year: abt 1808 Age in 1870: 62 Birthplace: Massachusetts Home in 1870: Veteran, Chemung, New York Race: White Gender: Male Post Office: Millport Name: Henry M. Sears Age: 72 Estimated birth year: <1808> Birthplace: Massachusetts Occupation: Farmer Relationship to head-of-household: Self Home in 1880: Veteran, Chemung, New York Marital status: Married Race: White Gender: Male Spouse's name: Mary E. Sears Father's birthplace: MA Mother's birthplace: MA

<https://www.ancestry.com/family-tree/person/tree/85916232/person/100095209766/facts> tree of Hayley Trainer

<https://www.ancestry.com/family-tree/person/tree/151491548/person/362007880024/facts> tree of Kathleen Jessop

<https://www.ancestry.com/family-tree/person/tree/5982931/person/292083247143/facts> tree of Idrogers11 sent message 11 Jan 2020

More facts and events for Henry Morris Sears:

Residence: 1860 Sandisfield, Berkshire, Massachusetts{ XE "USA, Massachusetts, Berkshire, Sandisfield:(42.1126° N, 73.1432° W):Sears, Henry Morris (1808–1878)" \f "Place" }^[177]

Residence: 1865 Veteran, Chemung, New York{ XE "USA, New York, Chemung, Veteran:(42.2498° N, 76.7877° W):Sears, Henry Morris (1808–1878)" \f "Place" }^[180]
Relation to Head of House: Head

Residence: 1865 Veteran{ XE "USA, New York, Chemung, Veteran:(42.2498° N, 76.7877° W):Sears, Henry Morris (1808–1878)" \f "Place" }^[180]
Age: 57; RelationToHead: Head

Residence: 1880 Veteran{ XE "USA, New York, Chemung, Veteran:(42.2498° N, 76.7877° W):Sears, Henry Morris (1808–1878)" \f "Place" }^[178]
Age: 72; Occupation: Farmer; EnumerationDistrict: 088; MaritalStatus: Married; RelationToHead: Self

77. He married **Mary E Wheeler**{ XE "Wheeler:Mary E (1825–)" \f "Name" \b \i }.^[178, 180, 182–183] They had six children: James (1854–), Sarah (1857–), Susy (ca.1858–), Mary (1867–), Eda and Sara.

Mary E was born in New York{ XE "USA, New York:(42.7531° N, 74.2224° W):Wheeler, Mary E (1825–)" \f "Place" } in 1825.^[178, 180, 182, 183] She was the daughter of James Wheeler{ XE "Wheeler:James" \f "Name" \i } and Mary Ann Smith{ XE "Smith:Mary Ann" \f "Name" \i }.

More facts and events for Mary E Wheeler:

Residence: 1865 Veteran{ XE "USA, New York, Chemung, Veteran:(42.2498° N, 76.7877° W):Wheeler, Mary E (1825–)" \f "Place" }^[180]
Age: 40; RelationToHead: Wife

Residence: 1865 Veteran{ XE "USA, New York, Chemung, Veteran:(42.2498° N, 76.7877° W):Wheeler, Mary E (1825–)" \f "Place" }^[182]

¹⁸² Ancestry.com, New York, State Census, 1865 (Provo, UT, USA, Ancestry.com Operations, Inc., 2014), Ancestry.com. [Source citation includes one media item]

¹⁸³ Ancestry.com, 1900 United States Federal Census (Provo, UT, USA, Ancestry.com Operations Inc, 2004), Ancestry.com, Year: 1900; Census Place: Veteran, Chemung, New York; Roll: 1016; Page: 4B; Enumeration District: 0043; FHL microfilm: 1241016. [Source citation includes one media item]

- Relation to Head of House: Wife
- Residence: 1880 Veteran{ XE "USA, New York, Chemung, Veteran:(42.2498° N, 76.7877° W):Wheeler, Mary E (1825-)" \f "Place" }^[178]
 Age: 55; Occupation: Keeping House; EnumerationDistrict: 088;
 MaritalStatus: Married; RelationToHead: Wife
- Residence: 1900 Veteran{ XE "USA, New York, Chemung, Veteran:(42.2498° N, 76.7877° W):Wheeler, Mary E (1825-)" \f "Place" }^[183]
 Marital Status: Widowed; Relation to Head of House: Head

Children of Henry Morris Sears and Mary E Wheeler:

- m I. **James Amos⁶ Sears**{ XE "Sears:James Amos (1854-)" \f "Name" \b } was born in perh, Sandisfield, Berkshire, Massachusetts,{ XE "USA, Massachusetts, Berkshire, Sandisfield, perh: :Sears, James Amos (1854-)" \f "Place" } on 22nd February 1854.
- f II. **Sarah Elizabeth Sears**{ XE "Sears:Sarah Elizabeth (1857-)" \f "Name" \b } was born in Sandisfield{ XE "USA, Massachusetts, Berkshire, Sandisfield:(42.1126° N, 73.1432° W):Sears, Sarah Elizabeth (1857-)" \f "Place" } in January 1857.^[178, 181, 183]



Sarah

More facts and events for Sarah Elizabeth Sears:

- Residence: 1880 Veteran{ XE "USA, New York, Chemung, Veteran:(42.2498° N, 76.7877° W):Sears, Sarah Elizabeth (1857-)" \f "Place" }^[178]
 Age: 23; Occupation: At Home; EnumerationDistrict: 088;
 MaritalStatus: Single; RelationToHead: Daughter
- Residence: 1900 Veteran{ XE "USA, New York, Chemung, Veteran:(42.2498° N, 76.7877° W):Sears, Sarah Elizabeth (1857-)" \f "Place" }^[183]
 Marital Status: Single; Relation to Head of House: Daughter
- f III. **Susy E Sears**{ XE "Sears:Susy E (ca.1858-)" \f "Name" \b } was born about 1858.^[180, 182]

More facts and events for Susy E Sears:

- Residence: 1865 Veteran{ XE "USA, New York, Chemung, Veteran:(42.2498° N, 76.7877° W):Sears, Susy E (ca.1858-)" \f "Place" }^[182]
 Relation to Head of House: Daughter
- Residence: 1865 Veteran{ XE "USA, New York, Chemung, Veteran:(42.2498° N, 76.7877° W):Sears, Susy E (ca.1858-)" \f "Place" }^[180]
 Age: 7; RelationToHead: Daughter
- f IV. **Mary Edia Sears**{ XE "Sears:Mary Edia (1867-)" \f "Name" \b } was born in New York{ XE "USA, New York:(42.7531° N, 74.2224° W):Sears, Mary Edia (1867-)" \f "Place" } in 1867.
- f V. **Eda Sears**{ XE "Sears:Eda" \f "Name" \b } was born in Chemung, New York{ XE "USA, New York, Chemung:(42.1409° N, 76.76° W):Sears, Eda" \f "Place" }.
- f VI. **Sara Elizabeth Sears**{ XE "Sears:Sara Elizabeth" \f "Name" \b } was born in Sandisfield, Berkshire, Massachusetts{ XE "USA, Massachusetts, Berkshire, Sandisfield:(42.1126° N, 73.1432° W):Sears, Sara Elizabeth" \f "Place" }.

Grandchildren{ TC "Grandchildren" \I 2 \f C}

Family of Edmund Sears and Jane Sage{ TC "Edmund Sears and Jane Sage" \I 3 \f C}

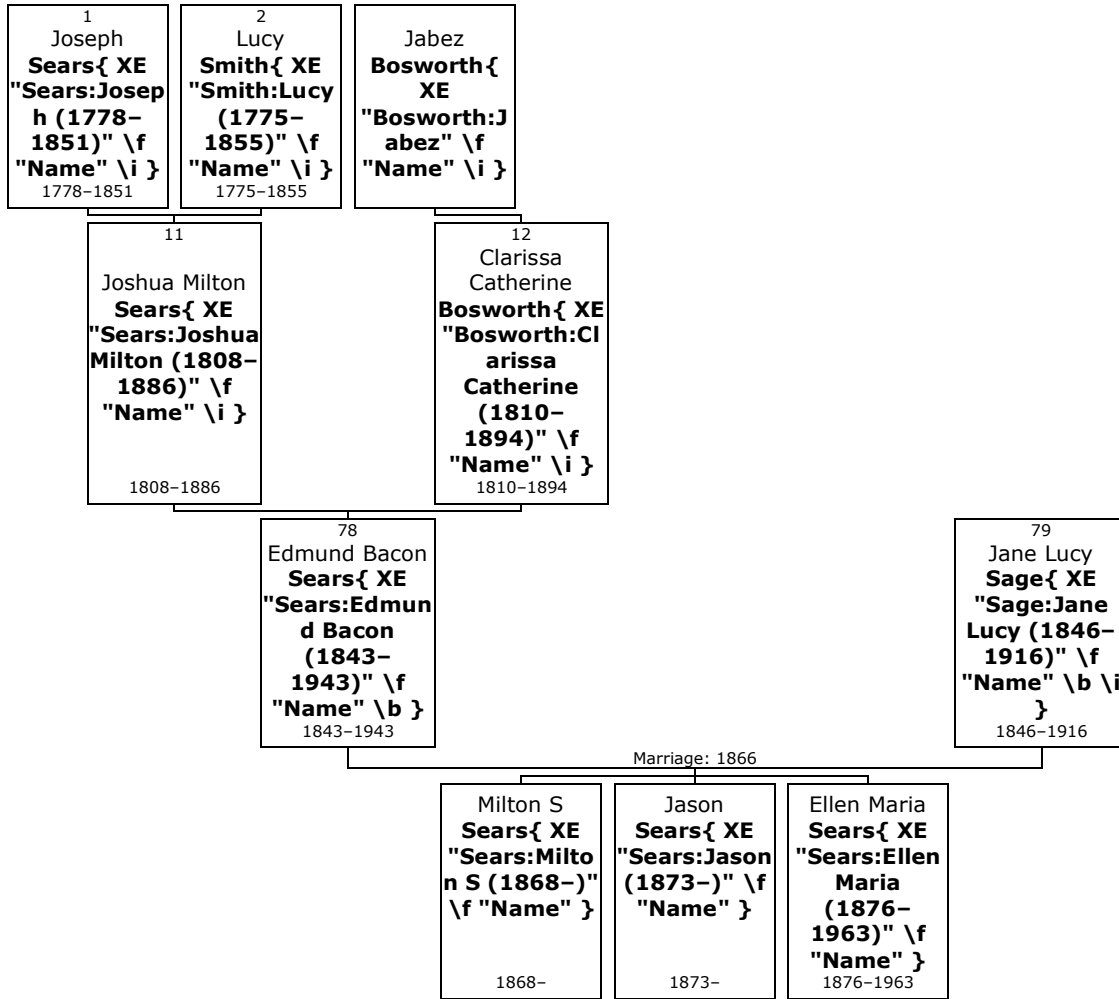

78. Edmund Bacon⁶ Sears{ XE "Sears:Edmund Bacon (1843-1943)" \f "Name" \b } (*Joshua Milton⁵, Hon Joseph⁴, Sarah³ Blackmore*) was born in April 1843 in Sandisfield, Berkshire, Massachusetts, USA{ XE "USA, Massachusetts, Berkshire, Sandisfield:(42.1126° N, 73.1432° W):Sears, Edmund Bacon (1843-1943)" \f "Place" }.^[184, 185, 186-187] He was the son of Joshua Milton Sears{ XE "Sears:Joshua Milton (1808-1886)" \f "Name" \i } (11) and Clarissa Catherine Bosworth{ XE "Bosworth:Clarissa Catherine (1810-1894)" \f "Name" \i } (12).

Edmund Bacon died in Sandisfield{ XE "USA, Massachusetts, Berkshire, Sandisfield:(42.1126° N, 73.1432° W):Sears, Edmund Bacon (1843-1943)" \f "Place" } in 1943 at the age of 99.^[185] He was buried

¹⁸⁴ Ancestry.com and The Church of Jesus Christ of Latter-day Saints, 1880 United States Federal Census (Provo, UT, USA, Ancestry.com Operations Inc, 2010), Ancestry.com, Year: 1880; Census Place: Sandisfield, Berkshire, Massachusetts; Roll: 520; Family History Film: 1254520; Page: 580C; Enumeration District: 038. [Source citation includes one media item]

¹⁸⁵ Ancestry.com, U.S., Find A Grave Index, 1600s-Current (Provo, UT, USA, Ancestry.com Operations, Inc., 2012), Ancestry.com.

¹⁸⁶ Ancestry.com, 1910 United States Federal Census (Provo, UT, USA, Ancestry.com Operations Inc, 2006), Ancestry.com, Year: 1910; Census Place: Sandisfield, Berkshire, Massachusetts; Roll: T624_572; Page: 3B; Enumeration District: 0084; FHL microfilm: 1374585. [Source citation includes one media item]

¹⁸⁷ Ancestry.com, Massachusetts, Town and Vital Records, 1620-1988 (Provo, UT, USA, Ancestry.com Operations, Inc., 2011), Ancestry.com. [Source citation includes one media item]

in Sandisfield{ XE "USA, Massachusetts, Berkshire, Sandisfield:(42.1126° N, 73.1432° W):Sears, Edmund Bacon (1843–1943)" \f "Place" }.^[185]

!John W Sears Archive: d. date

!S.P. May No 2490 p.504 Lives in Sandisfield, MA

!1870 Census Edmund B Sears Estimated Birth Year: abt 1844 Age in 1870: 26 Birthplace: Massachusetts Home in 1870: Sandisfield, Berkshire, Massachusetts Race: White Gender: Male Post Office: Hartsville Roll: M593_602 Page: 667 Image: 455 Year: 1870 1870 United States Federal Census

<http://www.ancestry.com/search/db.aspx?dbid=7163> Name: Edmund B Sears Birth Year: abt 1844 Age in 1870: 26 Birthplace: Massachusetts Home in 1870: Sandisfield, Berkshire, Massachusetts Race: White Gender: Male Post Office: Hartsville

Household Members: Name Age

Edmund B Sears 26

Jane L Sears 23

Milton Sears 1

Albert Granger 19

!

!1880 United States Federal Census <http://www.ancestry.com/search/db.aspx?dbid=6742> Name: Milton S. Sears Home in 1880: Sandisfield, Berkshire, Massachusetts Age: 11 Estimated birth year: abt 1869 Birthplace: Massachusetts Relation to Head of Household: Grandson Father's Name: Edmond B. Father's birthplace: Massachusetts Mother's Name: Jane L. Mother's birthplace: Massachusetts Occupation: At School Marital Status: Single Race: White Gender: Male

Household Members: Name Age

Joshua M. Sears 72

Katharine C. Sears 70

Edmond B. Sears 37

Jane L. Sears 35

Milton S. Sears 11

Jason Sears 7

Ellen M. Sears 3

!

!Edmond B. SEARS Age: 37 Estimated birth year: <1843> Birthplace: Massachusetts Occupation: Farmer Relationship to head-of-household: Son Home in 1880: Sandisfield, Berkshire, Massachusetts Marital status: Married Race: White Gender: Male Father's birthplace: MA Mother's birthplace: MA Image Source: Year: 1880; Census Place: Sandisfield, Berkshire, Massachusetts; Roll: T9_520; Family History Film: 1254520; Page: 580C; Enumeration District: 38; Image: 0642.

!

!1900 Census Vol 4,80,5,86 Sandisfield, Berkshire, MA

More facts and events for Edmund Bacon Sears:

Residence: 1880 Sandisfield{ XE "USA, Massachusetts, Berkshire, Sandisfield:(42.1126° N, 73.1432° W):Sears, Edmund Bacon (1843–1943)" \f "Place" }.^[184]
Marital Status: Married; Relation to Head: Son

Residence: 1910 Sandisfield{ XE "USA, Massachusetts, Berkshire, Sandisfield:(42.1126° N, 73.1432° W):Sears, Edmund Bacon (1843–1943)" \f "Place" }.^[186]
Marital Status: Married; Relation to Head of House: Head

- 79.** Edmund Bacon married **Jane Lucy Sage**{ XE "Sage:Jane Lucy (1846–1916)" \f "Name" \b \i } on Wednesday, 12th December 1866, in Sandisfield{ XE "USA, Massachusetts, Berkshire, Sandisfield:(42.1126° N, 73.1432° W):Sears, Edmund Bacon (1843–1943)" \f "Place" }.^[184–187] They had three children: Milton (1868–), Jason (1873–) and Ellen (1876–1963).

Jane Lucy was born in Massachusetts{ XE "USA, Massachusetts:(42.1562° N, 71.5662° W):Sage, Jane Lucy (1846–1916)" \f "Place" } in August 1846.^[184–186] She reached 69 years of age and died in Sandisfield{ XE "USA, Massachusetts, Berkshire, Sandisfield:(42.1126° N, 73.1432° W):Sage, Jane Lucy (1846–1916)" \f "Place" } on 8th February 1916.^[185] Jane Lucy was buried in Sandisfield{ XE "USA, Massachusetts, Berkshire, Sandisfield:(42.1126° N, 73.1432° W):Sage, Jane Lucy (1846–1916)" \f "Place" }.^[185]

More facts and events for Jane Lucy Sage:

Residence: 1880 Sandisfield{ XE "USA, Massachusetts, Berkshire, Sandisfield:(42.1126° N, 73.1432° W):Sage, Jane Lucy (1846–1916)" \f "Place" }.^[184]

Marital Status: Married; Relation to Head: Daughter-in-law
 Residence: 1910 Sandisfield{ XE "USA, Massachusetts, Berkshire, Sandisfield:(42.1126° N, 73.1432° W):Sage, Jane Lucy (1846–1916)" \f "Place" }^[186]
 Marital Status: Married; Relation to Head of House: Wife

Children of Edmund Bacon Sears and Jane Lucy Sage:

- m I. **Milton S⁷ Sears**{ XE "Sears:Milton S (1868–)" \f "Name" \b } was born in Sandisfield{ XE "USA, Massachusetts, Berkshire, Sandisfield:(42.1126° N, 73.1432° W):Sears, Milton S (1868–)" \f "Place" } on 16th December 1868.^[184]

More facts and events for Milton S Sears:

Residence: 1880 Sandisfield{ XE "USA, Massachusetts, Berkshire, Sandisfield:(42.1126° N, 73.1432° W):Sears, Milton S (1868–)" \f "Place" }^[184]

Marital Status: Single; Relation to Head: Grandson

- m II. **Jason Sears**{ XE "Sears:Jason (1873–)" \f "Name" \b } was born in Massachusetts{ XE "USA, Massachusetts:(42.1562° N, 71.5662° W):Sears, Jason (1873–)" \f "Place" } in 1873.^[184]

More facts and events for Jason Sears:

Residence: 1880 Sandisfield{ XE "USA, Massachusetts, Berkshire, Sandisfield:(42.1126° N, 73.1432° W):Sears, Jason (1873–)" \f "Place" }^[184]

Marital Status: Single; Relation to Head: Grandson

- f III. **Ellen Maria Sears**{ XE "Sears:Ellen Maria (1876–1963)" \f "Name" \b } was born in Sandisfield, Berkshire, Massachusetts,{ XE "USA, Massachusetts, Berkshire, Sandisfield:(42.1126° N, 73.1432° W):Sears, Ellen Maria (1876–1963)" \f "Place" } on 28th August 1876.^[184, 185, 187, 188, 189, 190, 191-192] She died in Winsted{ XE "USA, Connecticut, Litchfield, Winsted:(41.9212° N, 73.0601° W):Sears, Ellen Maria (1876–1963)" \f "Place" } on 15th October 1963, at the age of 87.^[185] Ellen Maria was buried in Winsted{ XE "USA, Connecticut, Litchfield, Winsted:(41.9212° N, 73.0601° W):Sears, Ellen Maria (1876–1963)" \f "Place" }.^[185]

More facts and events for Ellen Maria Sears:

Residence: 1880 Sandisfield, Berkshire, Massachusetts{ XE "USA, Massachusetts, Berkshire, Sandisfield:(42.1126° N, 73.1432° W):Sears, Ellen Maria (1876–1963)" \f "Place" }^[184]

Marital Status: Single; Relation to Head: Granddaughter

Residence: 1910 Winchester, Litchfield, Connecticut{ XE "USA, Connecticut, Litchfield,

¹⁸⁸ Ancestry.com, 1910 United States Federal Census (Provo, UT, USA, Ancestry.com Operations Inc, 2006), Ancestry.com, Year: 1910; Census Place: Winchester, Litchfield, Connecticut; Roll: T624_135; Page: 10A; Enumeration District: 0286; FHL microfilm: 1374148.

¹⁸⁹ Ancestry.com, 1920 United States Federal Census (Provo, UT, USA, Ancestry.com Operations Inc, 2010), Ancestry.com, Year: 1920; Census Place: Winchester, Litchfield, Connecticut; Roll: T625_187; Page: 5B; Enumeration District: 234.

¹⁹⁰ Ancestry.com, Massachusetts, Marriage Records, 1840-1915 (Provo, UT, USA, Ancestry.com Operations, Inc., 2013), Ancestry.com, New England Historic Genealogical Society; Boston, Massachusetts; Massachusetts Vital Records, 1911-1915.

¹⁹¹ Ancestry.com, 1940 United States Federal Census (Provo, UT, USA, Ancestry.com Operations, Inc., 2012), Ancestry.com, Year: 1940; Census Place: Winsted, Litchfield, Connecticut; Roll: T627_511; Page: 5B; Enumeration District: 3-80.

¹⁹² Ancestry.com, U.S., Social Security Applications and Claims Index, 1936-2007 (Provo, UT, USA, Ancestry.com Operations, Inc., 2015).

Winchester:(41.9251° N, 73.1032° W):Sears, Ellen Maria (1876–1963)" \f "Place" }^[188]
 Marital Status: Married; Relation to Head of House: Wife

Residence: 1920 Winchester{ XE "USA, Connecticut, Litchfield, Winchester:(41.9251° N, 73.1032° W):Sears, Ellen Maria (1876–1963)" \f "Place" }^[189]
 Relation to Head: Wife; Residence Marital Status: Married

Residence: 1935 Winsted{ XE "USA, Connecticut, Litchfield, Winsted:(41.9212° N, 73.0601° W):Sears, Ellen Maria (1876–1963)" \f "Place" }^[191]

Residence: 1st April 1940 Winsted{ XE "USA, Connecticut, Litchfield, Winsted:(41.9212° N, 73.0601° W):Sears, Ellen Maria (1876–1963)" \f "Place" }^[191]
 Marital Status: Married; Relation to Head of House: Wife

At the age of 22, Ellen Maria married **Wallace W Clark**{ XE "Clark:Wallace W (1872–1944)" \f "Name" \b \i } on Saturday, 22nd April 1899, in Sandisfield, Berkshire, Massachusetts,{ XE "USA, Massachusetts, Berkshire, Sandisfield:(42.1126° N, 73.1432° W):Sears, Ellen Maria (1876–1963)" \f "Place" } when he was 26 years old.^[185, 187–192] They had four children: Isabella (1899–), Emily (ca.1901–), Helen (ca.1903–) and Wallace (1912–1997).

Wallace W was born in Sandisfield{ XE "USA, Massachusetts, Berkshire, Sandisfield:(42.1126° N, 73.1432° W):Clark, Wallace W (1872–1944)" \f "Place" } on Thursday, 30th May 1872.^[185, 187–191] He was the son of Nathaniel Mattoon Clark{ XE "Clark:Nathaniel Mattoon (1822–1887)" \f "Name" \i } and Emily Ann Sage{ XE "Sage:Emily Ann (1829–1915)" \f "Name" \i }.

Wallace W reached 72 years of age and died in Winsted{ XE "USA, Connecticut, Litchfield, Winsted:(41.9212° N, 73.0601° W):Clark, Wallace W (1872–1944)" \f "Place" } on 28th September 1944.^[185] He was buried in Winsted{ XE "USA, Connecticut, Litchfield, Winsted:(41.9212° N, 73.0601° W):Clark, Wallace W (1872–1944)" \f "Place" }.^[185]

Family of Francis Sears and Mary Sparhawk{ TC "Francis Sears and Mary Sparhawk" \I 3 \f C}

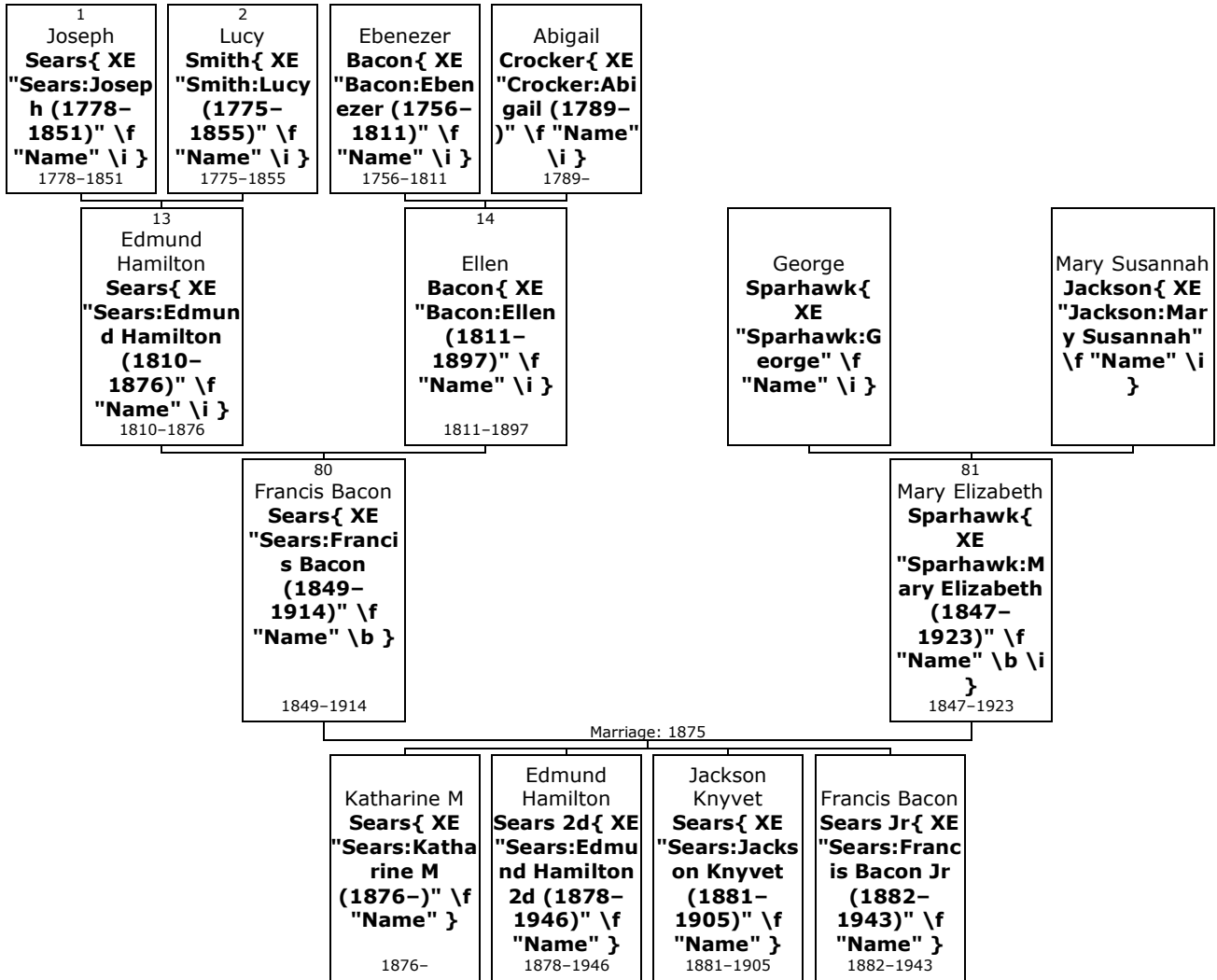

80. Francis Bacon⁶ Sears{ XE "Sears:Francis Bacon (1849-1914)" \f "Name" \b } (Rev Edmund Hamilton⁵, Hon Joseph⁴, Sarah³ Blackmore) was born on Sunday, 21st January 1849, in Wayland, Middlesex, Massachusetts, USA{ XE "USA, Massachusetts, Middlesex, Wayland:(42.3626° N, 71.3614° W):Sears, Francis Bacon (1849-1914)" \f "Place" }.^[193, 194, 195-196] He was the son of Edmund Hamilton Sears{ XE "Sears:Edmund Hamilton (1810-1876)" \f "Name" \i } (13) and Ellen Bacon{ XE "Bacon:Ellen (1811-1897)" \f "Name" \i } (14).

Francis Bacon died in Wayland, Middlesex,{ XE "USA, Massachusetts, Middlesex, Wayland:(42.3626° N, 71.3614° W):Sears, Francis Bacon (1849-1914)" \f "Place" } in July 1914 at the age of 65.^[193] He was buried in Weston{ XE "USA, Massachusetts, Middlesex, Weston:(42.3668° N, 71.3031° W):Sears, Francis Bacon (1849-1914)" \f "Place" }.^[193]

¹⁹³ Ancestry.com, U.S., Find A Grave Index, 1600s-Current (Provo, UT, USA, Ancestry.com Operations, Inc., 2012), Ancestry.com.

¹⁹⁴ Ancestry.com, Massachusetts, Marriage Records, 1840-1915 (Provo, UT, USA, Ancestry.com Operations, Inc., 2013), Ancestry.com, New England Historic Genealogical Society; Boston, Massachusetts; Massachusetts Vital Records, 1911-1915. [Source citation includes one media item]

¹⁹⁵ Ancestry.com, 1910 United States Federal Census (Provo, UT, USA, Ancestry.com Operations Inc, 2006), Ancestry.com, Year: 1910; Census Place: Boston Ward 11, Suffolk, Massachusetts; Roll: T624_618; Page: 7A; Enumeration District: 1424; FHL microfilm: 1374631. [Source citation includes one media item]

¹⁹⁶ Ancestry.com, U.S., Social Security Applications and Claims Index, 1936-2007 (Provo, UT, USA, Ancestry.com Operations, Inc., 2015).

!BIRTH-FATHER-SPOUSE-CHILDREN-DEATH-BIOGRAPHY: Samuel Pearce May, THE DESCENDANTS OF RICHARD SARES(SEARS) OF YARMOUTH,MASS; 1638-1888; Albany, Joel Munsell's Sons, 1890; No 2492, p 504; NEHGS Library, Boston, MA. Is a cashier of Third National Bank, Boston

!

!Burke's Family Genealogy - Vice-President, National Shawmut Bank, Boston. shows b. date as 23 Feb 1849

!

!1900 Census Vol 54,993,1,68 Weston, Middlesex, MA

!

!Mayflower Index: No. 29,947 Francis B; spouse Mary E Sparhawk; father Edmund H Wayland T.R. b. 29 Jan

!

!NY Times 1 Dec 1901 Two Boston Banks Combine The doors of the Third National Bank were closed at noon to-day and that institution ceased to exist. On Monday, by vote of the holders of more than two-thirds of the capital stock of the bank, it becomes consolidated with the National Shawmut Bank. President Francis B. Sears of the Third National Bank becomes a Vice President of the Shawmut National, George Grant, Vice President of the Third, becoming an office of the Shawmut, and Moses B. Williams, Henry B Endicott and Joseph B Russell being added to the Board of Directors. Boston, Aug 26[1914] Francis B. Sears Dies Vice Chairman of the Board of Directors of the National Shawmut Bank and prominently identified with many movements for civic betterment, died at his Summer home in Weston, Mass. today, aged sixty-five years.

More facts and events for Francis Bacon Sears:

Residence: 1910 Ward 11, Boston, Suffolk{ XE "USA, Massachusetts, Suffolk, Boston, Ward 11: :Sears, Francis Bacon (1849-1914)" \f "Place" }^[195]
Marital Status: Married; Relation to Head of House: Head

81. Francis Bacon married **Mary Elizabeth Sparhawk**{ XE "Sparhawk:Mary Elizabeth (1847-1923)" \f "Name" \b \i } on Friday, 11th June 1875, in Wareham, Plymouth{ XE "USA, Massachusetts, Plymouth, Wareham:(41.7626° N, 70.7217° W):Sears, Francis Bacon (1849-1914)" \f "Place" }.^[194-196] They had four children: Katharine (1876-), Edmund (1878-1946), Jackson (1881-1905) and Francis (1882-1943). Mary Elizabeth was born in Boston, Suffolk,{ XE "USA, Massachusetts, Suffolk, Boston:(42.3583° N, 71.0603° W):Sparhawk, Mary Elizabeth (1847-1923)" \f "Place" } in 1847.^[194, 195] She was the daughter of George Sparhawk{ XE "Sparhawk:George" \f "Name" \i } and Mary Susannah Jackson{ XE "Jackson:Mary Susannah" \f "Name" \i }.

Mary Elizabeth reached 76 years of age and died in 1923.

More facts and events for Mary Elizabeth Sparhawk:

Residence: 1910 Ward 11{ XE "USA, Massachusetts, Suffolk, Boston, Ward 11: :Sparhawk, Mary Elizabeth (1847-1923)" \f "Place" }^[195]
Marital Status: Married; Relation to Head of House: Wife

Children of Francis Bacon Sears and Mary Elizabeth Sparhawk:

- f I. **Katharine M⁷ Sears**{ XE "Sears:Katharine M (1876-)" \f "Name" \b } was born in Weston, Middlesex,{ XE "USA, Massachusetts, Middlesex, Weston:(42.3668° N, 71.3031° W):Sears, Katharine M (1876-)" \f "Place" } on 22nd July 1876.^[194-196]

More facts and events for Katharine M Sears:

Residence: 1910 Ward 11{ XE "USA, Massachusetts, Suffolk, Boston, Ward 11: :Sears, Katharine M (1876-)" \f "Place" }^[195]
Marital Status: Married; Relation to Head of House: Daughter

Katharine M married **Henry A Endicott Jr**{ XE "Endicott:Henry A Jr (1872-)" \f "Name" \b \i } on Tuesday, 15th October 1907, in Boston{ XE "USA, Massachusetts, Suffolk, Boston:(42.3583° N, 71.0603° W):Sears, Katharine M (1876-)" \f "Place" }.^[194] They had two children: Ellen (1908-) and William (1909-1980).

Henry A was born in Beverly, Essex,{ XE "USA, Massachusetts, Essex, Beverly:(42.5584° N, 70.88° W):Endicott, Henry A Jr (1872-)" \f "Place" } in 1872.^[194] He was the son of Henry Endicott{ XE "Endicott:Henry" \f "Name" \i }.

1930 census Lawyer

- m II. **Edmund Hamilton Sears 2d**{ XE "Sears:Edmund Hamilton 2d (1878-1946)" \f "Name" \b } was born in Brighton, Suffolk,{ XE "USA, Massachusetts, Suffolk, Brighton:(42.35° N, 71.1569° W):Sears, Edmund Hamilton 2d (1878-1946)" \f "Place" } on 28th June 1878.^[194, 197, 198] He died in Wayland{ XE "USA, Massachusetts, Middlesex, Wayland:(42.3626° N, 71.3614° W):Sears, Edmund Hamilton 2d (1878-1946)" \f "Place" } on 21st July 1946, at the age of 68.

More facts and events for Edmund Hamilton Sears 2d:

Residence: 1910 Ward 11, Boston, Suffolk{ XE "USA, Massachusetts, Suffolk, Boston, Ward 11: :Sears, Edmund Hamilton 2d (1878-1946)" \f "Place" }^[197]
Marital Status: Married; Relation to Head of House: Head

Residence: 1920 Ward 3, New Bedford, Bristol{ XE "USA, Massachusetts, Bristol, New Bedford, Ward 3: :Sears, Edmund Hamilton 2d (1878-1946)" \f "Place" }
Relation to Head: Head; Residence Marital Status: Married

Residence: 1935 Wayland, Middlesex{ XE "USA, Massachusetts, Middlesex, Wayland:(42.3626° N, 71.3614° W):Sears, Edmund Hamilton 2d (1878-1946)" \f "Place" }^[198]

Residence: 1st April 1940 Wayland{ XE "USA, Massachusetts, Middlesex, Wayland:(42.3626° N, 71.3614° W):Sears, Edmund Hamilton 2d (1878-1946)" \f "Place" }^[198]
Marital Status: Married; Relation to Head of House: Head

Edmund Hamilton married **Helen Clark Swazey**{ XE "Swazey:Helen Clark" \f "Name" \b \i }.

At the age of 25, Edmund Hamilton married **Leslie Buckingham**{ XE "Buckingham:Leslie (1883-1911)" \f "Name" \b \i } on Tuesday, 22nd March 1904, in Weston{ XE "USA, Massachusetts, Middlesex, Weston:(42.3668° N, 71.3031° W):Sears, Edmund Hamilton 2d (1878-1946)" \f "Place" } when she was 20 years old.^[194, 197] They had three children: Mary (1905-1997), Edmund (1907-1976) and Kit (1909-1995).

Leslie was born in Brookline, Norfolk,{ XE "USA, Massachusetts, Norfolk, Brookline:(42.3318° N, 71.1211° W):Buckingham, Leslie (1883-1911)" \f "Place" } on Tuesday, 3rd July 1883.^[194, 197] She reached 28 years of age and died in Wayland, Middlesex,{ XE "USA, Massachusetts, Middlesex, Wayland:(42.3626° N, 71.3614° W):Buckingham, Leslie (1883-1911)" \f "Place" } on 29th August 1911.

!BIRTH-DEATH-SIBLINGS: Letter from Leila Sears, N Pomfret, VT, to Ray Sears in Duncan, OK; 1878-1946; Letter dtd 1 Feb 1994; ;copy in poss of Ray Sears. She is sister

¹⁹⁷ Ancestry.com, 1910 United States Federal Census (Provo, UT, USA, Ancestry.com Operations Inc, 2006), Ancestry.com, Year: 1910; Census Place: Boston Ward 11, Suffolk, Massachusetts; Roll: T624_618; Page: 18A; Enumeration District: 1424; FHL microfilm: 1374631.

¹⁹⁸ Ancestry.com, 1940 United States Federal Census (Provo, UT, USA, Ancestry.com Operations, Inc., 2012), Ancestry.com, Year: 1940; Census Place: Wayland, Middlesex, Massachusetts; Roll: T627_1621; Page: 6A; Enumeration District: 9-608.

to Marian, wife of Edmund's brother, Francis. Mrs Leslie B. Sears, 28 years old, died Wednesday at Wayland, Mass., of infantile paralysis. She was the wife of Edmund Hamilton Sears, son of Francis B. Sears, Vice President of the National Shawmut Bank of Boston. NYTimes 1 Sep 1911

At the age of 38, Edmund Hamilton Sears 2d married **Sophia Whitney Bennett**{ XE "Bennett:Sophia Whitney (1883–1980)" \f "Name" \b \i } on Thursday, 25th January 1917, when she was 33 years old.^[198] They had three children: John (1918–2006), Leila (1919–2008) and Elisabeth (1921–2011).

Sophia Whitney was born in Medford{ XE "USA, Massachusetts, Middlesex, Medford:(42.4184° N, 71.1062° W):Bennett, Sophia Whitney (1883–1980)" \f "Place" } on Sunday, 25th February 1883.^[198] She reached 97 years of age and died in Wayland{ XE "USA, Massachusetts, Middlesex, Wayland:(42.3626° N, 71.3614° W):Bennett, Sophia Whitney (1883–1980)" \f "Place" } on 20th July 1980.

!BIRTH-DEATH:Letter from Leila Sears, N Pomfret, VT, to Ray Sears in Duncan, OK; 1878-1946; Letter dtd 1 Feb 1994; ;copy in poss of Ray Sears.

!31 Jul 1980- obit Wayland paper Sophia W. (Bennett) Sears, 97, of Pelham Island Rd died July 22.

Born in West Medford in 1883, she was the next to the youngest of the eight children of Theodore W. and Anna (Mellen) Bennett. Mrs. Sears was the last surviving family member of her generation.

Her maternal grandfather, Judge Edward Mellen, played an important role as chairman of the committee for the naming of Wayland. Her other grandfather, Josiah Bennett, was a founder of the Charlestown Savings Bank.

The Bennett family wintered in West Medford, but spent most summers in Wayland.

Bennett family life was unusual in two respects: first, their Sunday afternoons were dedicated to music-making. Their father saw to it that each could play an instrument. Mrs. Sears attended the Boston Symphony concerts; beginning at the age of three she heard every conductor from the earliest until, and including, the incumbency of William Steinberg.

The other unusual aspect of Bennett life was the enjoyment of outdoor activity, especially horseback riding. The Bennett girls scandalized their contemporaries and were known as the Bloomer Girls because they rode horseback astride, rather than sidesaddle. They enjoyed considerably more freedom as children than was customary in their day, and could tell of some very colorful adventures.

Career as a teacher

Following graduation from Radcliffe in 1906, Mrs. Sears, having qualified for the profession at Columbia University's Teachers' College, began a 10-year career at the Winsor School of Boston, where she had spent her pre-Radcliffe years as a student. She always treasured her long association with Miss Winsor and with the latter's sister, Mrs. Pearson (mother of Henry G Pearson of Wayland), as having important influence and inspiration for her.

In January 1917, her marriage to widower Edmund H. Sears II of Boston and Wayland ended the teaching chapter of her life, and she undertook the upbringing of three step-children: Mary (who had been her pupil at Winsor School), Edmund H. Sears, Jr., who died in 1976, and Katharine C.

Mrs. Sears' own children, all of whom have survived her, are John, Leila (a former Wayland town clerk), and Elisabeth.

Role of music

Music continued to be an important part of her life, shared by her husband, who often accompanied her on the piano. While all three of her own children have been musical, John, the oldest, developed the most notable talent on the piano, around which his career has centered.

Mrs. Sears herself could not devote as much time and attention to her violin as she would have liked during the busier family years. Following the death of her husband in 1946, with the children having reached independent years, the next 23 years brought the chance for intensive enjoyment of amateur music-making with a growing circle of friends, most of them of a generation younger than herself. There were various combinations of people to form quartets, trios and other chamber groups. She played with the Brandenburg group in Cambridge, was a charter member of the Concord Orchestra, and a member of the Lexington Music Club.

During these years, rehearsing in each others' home, where her colleagues' young

children would drift in and out during the music time, another generation was added to her list of important friends, whose affection for her reflected her own love for all children.

Throughout this time, the second violin role of her childhood persisted. She always preferred to play an inner part because, she said, it forced one to listen to the harmony and interweaving of voices as a whole, less easy to do when, in the first violin part, one had to worry about the voice that stood apart, to be followed by the others. She also carried with her, through those years, the admonitions of her father always to revere the music being played, and to make it sing, never merely to "play the notes."

Only when she fell and broke an arm at about 80 years of age did her violin days come to an end.

She remarked that it was probably as well; no one was ever going to tell her if her ear was going out of tune. About this time, she also acknowledged that there was a hazard factor at her age, and she gave up driving a car, even though it meant a big sacrifice of independence.

However, her younger friends saw to it that she was not entirely left behind. From time to time, when they had worked up a program to a certain point, they would take her to their rehearsals to let her "coach" them.

Even after she became a patient at the Kathryn Barton Nursing Home, where she spent her last six years, her friends would bring their instruments and offer programs of live music for her.

Always active in the reunions of her Radcliffe Class of 1906 and continuing ties with the class...[missed the rest]

m III. **Jackson Knyvet Sears**{ XE "Sears:Jackson Knyvet (1881-1905)" \f "Name" \b } was born in Boston{ XE "USA, Massachusetts, Suffolk, Boston:(42.3583° N, 71.0603° W):Sears, Jackson Knyvet (1881-1905)" \f "Place" } in May 1881. He died in Weston, Middlesex,{ XE "USA, Massachusetts, Middlesex, Weston:(42.3668° N, 71.3031° W):Sears, Jackson Knyvet (1881-1905)" \f "Place" } in 1905 at the age of 23.

m IV. **Francis Bacon Sears Jr**{ XE "Sears:Francis Bacon Jr (1882-1943)" \f "Name" \b } was born in Brighton{ XE "USA, Massachusetts, Suffolk, Brighton:(42.35° N, 71.1569° W):Sears, Francis Bacon Jr (1882-1943)" \f "Place" } on 21st June 1882. He died in July 1943 at the age of 61.

Francis Bacon Sears Jr married **Marian Buckingham**{ XE "Buckingham:Marian (1881-1943)" \f "Name" \b \i } in 1906. They had three children: Francis (1907-1928), Rosamond (1910-1992) and Edwin (1911-1987).

Marian was born on Friday, 17th June 1881. Of Brookline. She reached 61 years of age and died in February 1943.

!BIRTH:Letter from Leila Sears, N Pomfret, VT, to Ray Sears in Duncan, OK; 1878-1946; Letter dtd 1 Feb 1994; ;copy in poss of Ray Sears. She may have been born earlier. She is the sister of Leslie, wife to Francis' brother, Edmund.

Family of Edmund Sears and Helen Swazey{ TC "Edmund Sears and Helen Swazey" \I 3 \f C}

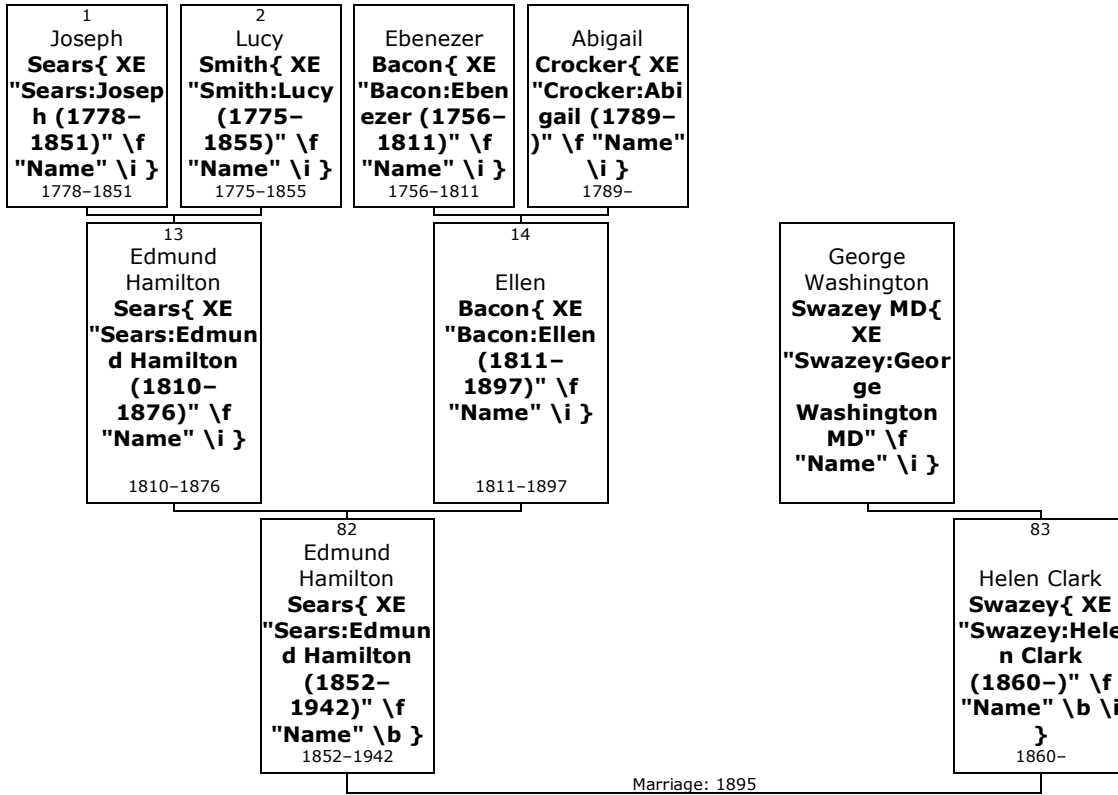

- 82. Edmund Hamilton⁶ Sears**{ XE "Sears:Edmund Hamilton (1852-1942)" \f "Name" \b } (*Rev Edmund Hamilton⁵, Hon Joseph⁴, Sarah³ Blackmore*) was born on Tuesday, 20th April 1852, in perh, Wayland, Middlesex, Massachusetts, USA{ XE "USA, Massachusetts, Middlesex, Wayland, perh: :Sears, Edmund Hamilton (1852-1942)" \f "Place" }.^[199, 200] He was the son of Edmund Hamilton Sears{ XE "Sears:Edmund Hamilton (1810-1876)" \f "Name" \i } (13) and Ellen Bacon{ XE "Bacon:Ellen (1811-1897)" \f "Name" \i } (14).

Edmund Hamilton died in Los Angeles, California,{ XE "USA, California, Los Angeles:(34.1847° N, 118.262° W):Sears, Edmund Hamilton (1852-1942)" \f "Place" } on 29th July 1942, at the age of 90.^[199]

!S.P. May No 2493 p.369 grad Yale, 1874; lives in Weston. Handnotes show grad Harvard vice Yale !Harvard Univ directory [C 1870-4 A.B.; A.M. Washington, MO 1897 Ed.] !Burke's Genealogy - Instructor in Latin and Greek, Univ. of Calif, 1875-83, Principal of large private school (Mary Institute)in St Louis, under the charter of Wash. Univ., 1891-1925, author of several books, including the Political History of XIX Century. Harvard, A.B. 1874. Wash. Univ of St Louis, MO Litt.D. Residences: Algonquin Club, Boston and Californian Club, Los Angeles. Author's Club, London, England !LS writes that he was her grandfather's brother and a series of essays, reminiscences of thos days, appeared in the New Yorker, became the basis for a Broadway play, "Junior Miss," later adapted into a motion picture. Biography and Genealogy Master Index, 2d ed, Gale Research, ISBN 0-8103-1094-5, p140; AmLY, WhNAA, NatCAB 31, WhAm 2 <http://archivegrid.org/web/jsp/a.jsp?id=526&fileloc=CHSV02-B234&archive=California+Historical+Society> Edmund Hamilton Sears letters : Oakland, Calif., to Charles M. Green, in Boston, Mass. : ALS, 1879-1883. Sears, Edmund Hamilton, 1852-1942. 1 folder (0.1 linear ft.) Contact an archivist to learn moreabout access to materials in this collection California Historical Society <javascript:showArchive('526','California+Historical+Society')>North Baker Research LibraryAddress: 678 Mission Street, San Francisco, CA 94105.CHiShelving control number: MS1934 Notes and Summaries: !Teacher and author; instructor, Classics Dept., University of California, Berkeley, 1875-1883. In Aug.

¹⁹⁹ Ancestry.com, California, Death Index, 1940-1997 (Provo, UT, USA, Ancestry.com Operations Inc, 2000), Ancestry.com, Date: 1942-07-29.

²⁰⁰ Ancestry.com, U.S. Passport Applications, 1795-1925 (Provo, UT, USA, Ancestry.com Operations, Inc., 2007), Ancestry.com, National Archives and Records Administration (NARA); Washington D.C.; NARA Series: Passport Applications, January 2, 1906 - March 31, 1925; Roll #: 1902; Volume #: Roll 1902 - Certificates: 144600-144975, 12 Apr 1922-13 Apr 1922. [Source citation includes one media item]

1883, George W. Bunnell, head of the Classics Dept., charged Sears with insubordination. Sears was dismissed by the Board of Regents later that year. Twenty-six letters to Green, a close friend and Harvard classmate of Sears. The letters discuss Calif. and national politics, Sears' health, friendship, and social, religious, and medical subjects. Source of Acquisition: Morrill, Edward Boston, MA Gift 1953 Number not found. This collection covers: Sears, Edmund Hamilton, 1852-1942. Green, Charles M. (Charles Montraville), 1850-1928. University of California, Berkeley. Dept. of Classics. University of California, Berkeley - Faculty. College teachers - California Correspondence. Classical literature - Study and teaching. Green, Charles M. (Charles Montraville), 1850-1928. RLG Union Catalog Record ID: CHSV02-B234 Sears, Edmund Hamilton 1852- The American Literary Yearbook. A biographical and bibliographical dictionary of living North American authors. Volume 1, 1919. Edited by Hamilton Traub. Hennig, MN: Paul Traub, 1919. Reprint. Detroit: Gale Research, 1968. "Biographical and Bibliographical Dictionary of Living North American Authors" section begins on page 57. (AmLY) Who Was Who among North American Authors, 1921-1939. Compiled from "Who's Who among North American Authors," Volumes 1-7, 1921-1939. Two volumes. Gale Composite Biographical Dictionary Series, Number 1. Detroit: Gale Research, 1976. (WhNAA) 1028141 Sears, Edmund Hamilton 1852-1942 The National Cyclopaedia of American Biography. Volume 31. New York: James T. White & Co., 1944. Reprint. Volumes 1-50. Ann Arbor, Mich.: University Microfilms, 1967-1971. Use the Index to locate biographies. (NatCAB 31) Who Was Who in America. A companion biographical reference work to "Who's Who in America." Volume 2, 1943-1950. Chicago: A.N. Marquis Co., 1963. (WhAm 2) 1940 United States Federal Census http://www.ancestry.com/search/db.aspx?dbid=2442&enc=1 about Hamilton Eder Sears Name: Hamilton Eder Sears Age: 88 Estimated Birth Year: abt 1852 Gender: Male Race: White Birthplace: Massachusetts Marital Status: Married Relation to Head of House: Head Home in 1940: Los Angeles, Los Angeles, California View Map <script>showMap('Los Angeles, Los Angeles, California')</script> Street: So Virgil Avenue House Number: 639 Inferred Residence in 1935: Los Angeles, Los Angeles, California Residence in 1935: Same Place Sheet Number: 62B Neighbors: View others on page http://cgi-bin/sse.dll?db=1940usfedcen&sin=C0000006&iv=m-t0627-00395-00587 Household Members: Name Age Hamilton Eder Sears http://search.ancestry.com/cgi-bin/sse.dll?db=1940usfedcen&indiv=try&h=71407184 88 Hellen Sears http://search.ancestry.com/cgi-bin/sse.dll?db=1940usfedcen&indiv=try&h=71407187 80 http://www.thespectrum.com/article/20131214/LIFESTYLE/312140024/Reflections-forgotten-song-peace-Earth?nclick_check=1 Reflections on a forgotten song of peace on Earth Dec. 14, 2013 ! 1 Comment http://www.pinterest.com/pin/create/button/?url=http%3A%2F%2Fwww.thespectrum.com%2Farticle%2F20131214%2FLIFESTYLE%2F312140024&media=http%3A%2F%2Fwww.thespectrum.com%2Fodygci%2Ffirefly%2Fpinterest%2FG3.jpg&guid=Gvx7mzQFQ4Cy-0&description=Reflections on a forgotten song of peace on Earth <script>void(null);</script> <script>void(null);</script> <script>void(null);</script> <script>void(null);</script> <script>void(null);</script> <script>void(null);</script> <script>void(null);</script> <script>void(null);</script> <script>void(null);</script> <script>void(null);</script> <script>void(null);</script> <script>void(null);</script> <script>void(null);</script> <script>void(null);</script> Written by JJ Abernathy Music Times Filed Under Features section/LIFESTYLE ADVERTISEMENT The Rev. Edward Hamilton Sears is known as the Unitarian pastor who composed the beautiful Christmas carol "It Came upon the Midnight Clear." Indeed, Sears, like a stalwart sentinel, created this song to herald a new day of peace and joy. When he rendered the hymn a poem, he titled his masterpiece "Peace on Earth." Sears (1810-1876) composed this carol in 1849 in Massachusetts, and it was published in "Christian Register." Sears' contemporary Richard Willis, who studied music in Europe with Felix Mendelssohn, provided the inspiration behind the musical adaptation. Sharon Olsen, my brilliant musician friend, recently lamented that we sing this song all too rarely at Christmas. Like a modern lamplighter and in her kind way, she commented, "No finer carol has been written, and we hear it far too rarely." I have been musing on my friend's statement ever since. When the dark clouds of the Civil War were gathering, Sears penned the words to this carol. Troubled by the issue of slavery, Sears envisioned a time when the message of the angels who had appeared to the shepherds in Judea would be realized. This marvelous message of faith, recounted in the second chapter of Luke, tells the good tidings of the angels: "Glory to God in the highest, and on earth, peace, good will toward all men." In verse, Sears captured his concern for the social upheavals of his time and the impact of the angels' "heavenly music [floating] over all the weary world." With bright buoyancy, Sears believed this message of optimism and peace would prevail. One verse Sears penned, though not often heard, seems especially poignant and profound in light of modern-day discord and dissension within the weary world: Yet with the woes of sin and strife / The world has suffered long; / Beneath the heavenly strain have rolled / Two thousand years of wrong; / And man, at war with man, hears not / The tidings which they bring; / O hush the noise, ye men of strife, / And hear the angels sing! It has been nine years since my husband gave me a great Christmas gift that continues to give: the miracle of satellite radio. This year, we discovered Holiday Pops on channel 75 of Sirius XM, classical Christmas music transmitted to our home

from space in digital stereo. I have especially noticed the varied carols, the sweet, uplifting sounds of eternal hope and joy. "It Came upon the Midnight Clear" is certainly among them. I agree with Sharon? truly, this carol is among the greats. Listening to it carries me to Judea, where I feel one with the shepherds and the angels, who together shared the vision of "when the new heav?n and earth shall own the Prince of Peace their King, and the whole world send back the song which now the angels sing." Oh, how I wish Christmas lasted all year through! Portions of this feature were published in December 2005. JJ Abernathy is an educator and arts advocate. Contact her at musictimes.horizons@gmail.com <mailto:musictimes.horizons@gmail.com>.

More facts and events for Edmund Hamilton Sears:

Residence: St Louis, Sussown^[200]

83. Edmund Hamilton married **Helen Clark Swazey**{ XE "Swazey:Helen Clark (1860-)" \f "Name" \b \i } in June 1895. They had no known children.

Helen Clark was born in 1860. She was the daughter of George Washington Swazey MD{ XE "Swazey:George Washington MD" \f "Name" \i }.

!Burke's Family Genealogy of British Ancestors p.2905

Bibliography{ TC "Bibliography" \f C}

"Ancestry Family Tree".

Ancestry Family Trees. Online publication - Provo, UT, USA: Ancestry.com. Original data: Family Tree files submitted by Ancestry members..

Ancestry.com and The Church of Jesus Christ of Latter-day Saints. *1880 United States Federal Census*. Provo, UT, USA: Ancestry.com Operations Inc, 2010.

Ancestry.com. *1790 United States Federal Census*. Provo, UT, USA: Ancestry.com Operations, Inc., 2010.

Ancestry.com. *1810 United States Federal Census*. Provo, UT, USA: Ancestry.com Operations, Inc., 2010.

Ancestry.com. *1830 United States Federal Census*. Provo, UT, USA: Ancestry.com Operations, Inc., 2010.

Ancestry.com. *1850 United States Federal Census*. Provo, UT, USA: Ancestry.com Operations, Inc., 2009.

Ancestry.com. *1860 United States Federal Census*. Provo, UT, USA: Ancestry.com Operations, Inc., 2009.

Ancestry.com. *1870 United States Federal Census*. Provo, UT, USA: Ancestry.com Operations, Inc., 2009.

Ancestry.com. *1900 United States Federal Census*. Provo, UT, USA: Ancestry.com Operations Inc, 2004.

Ancestry.com. *1910 United States Federal Census*. Provo, UT, USA: Ancestry.com Operations Inc, 2006.

Ancestry.com. *1920 United States Federal Census*. Provo, UT, USA: Ancestry.com Operations Inc, 2010.

Ancestry.com. *1940 United States Federal Census*. Provo, UT, USA: Ancestry.com Operations, Inc., 2012.

Ancestry.com. *Alabama, Select Marriages, 1816-1942*. Provo, UT, USA: Ancestry.com Operations, Inc, 2014.

Ancestry.com. *California, Death Index, 1940-1997*. Provo, UT, USA: Ancestry.com Operations Inc, 2000.

Ancestry.com. *Connecticut Town Birth Records, pre-1870 (Barbour Collection)*. Provo, UT, USA: Ancestry.com Operations Inc, 2006.

Ancestry.com. *Connecticut Town Death Records, pre-1870 (Barbour Collection)*. Provo, UT, USA: Ancestry.com Operations Inc, 2006.

Ancestry.com. *Connecticut, Church Record Abstracts, 1630-1920*. Provo, UT, USA, 2013.

Ancestry.com. *Connecticut, Deaths and Burials Index, 1650-1934*. Provo, UT, USA: Ancestry.com Operations, Inc., 2011.

Ancestry.com. *Connecticut, Hale Cemetery Inscriptions and Newspaper Notices, 1629-1934*. Provo, UT, USA: Ancestry.com Operations, Inc., 2012.

Ancestry.com. *Connecticut, Town Marriage Records, pre-1870 (Barbour Collection)*. Provo, UT, USA: Ancestry.com Operations Inc, 2006.

Ancestry.com. *Early Connecticut Marriages*. Provo, UT, USA: Ancestry.com Operations, Inc., 2012.

Ancestry.com. *Illinois, Marriage Index, 1860-1920*. Provo, UT, USA: Ancestry.com Operations, Inc., 2015.

Ancestry.com. *Iowa, Cemetery Records, 1662-1999*. Provo, UT, USA: Ancestry.com Operations Inc, 2000.

Ancestry.com. *Iowa, Select Marriages, 1809-1992*. Provo, UT, USA: Ancestry.com Operations, Inc, 2014.

- Ancestry.com. *Massachusetts, Marriage Records, 1840-1915*. Provo, UT, USA: Ancestry.com Operations, Inc., 2013.
- Ancestry.com. *Massachusetts, Town and Vital Records, 1620-1988*. Provo, UT, USA: Ancestry.com Operations, Inc., 2011.
- Ancestry.com. *Mayflower Births and Deaths, Vol. 1 and 2*. Provo, UT, USA: Ancestry.com Operations, Inc., 2013.
- Ancestry.com. *Michigan, Death Records, 1867-1950*. Provo, UT, USA: Ancestry.com Operations, Inc., 2015.
- Ancestry.com. *Michigan, Death Records, 1897-1920*. Provo, UT, USA: Ancestry.com Operations, Inc., 2010.
- Ancestry.com. *New Hampshire, Death and Burial Records Index, 1654-1949*. Provo, UT, USA: Ancestry.com Operations, Inc., 2011.
- Ancestry.com. *New York, State Census, 1855*. Provo, UT, USA: Ancestry.com Operations, Inc., 2013.
- Ancestry.com. *New York, State Census, 1865*. Provo, UT, USA: Ancestry.com Operations, Inc., 2014.
- Ancestry.com. *New York, State Census, 1875*. Provo, UT, USA: Ancestry.com Operations, Inc., 2013.
- Ancestry.com. *New York, Wills and Probate Records, 1659-1999*. Provo, UT, USA: Ancestry.com Operations, Inc., 2015.
- Ancestry.com. *North America, Family Histories, 1500-2000*. Provo, UT, USA: Ancestry.com Operations, Inc., 2016.
- Ancestry.com. *Pennsylvania, Death Certificates, 1906-1963*. Provo, UT, USA: Ancestry.com Operations, Inc., 2014.
- Ancestry.com. *Selected U.S. Federal Census Non-Population Schedules, 1850-1880*. Provo, UT, USA: Ancestry.com Operations, Inc., 2010.
- Ancestry.com. *South Dakota, Death Index, 1879-1955*. Provo, UT, USA: Ancestry.com Operations, Inc., 2004.
- Ancestry.com. *U.S. Passport Applications, 1795-1925*. Provo, UT, USA: Ancestry.com Operations, Inc., 2007.
- Ancestry.com. *U.S. Pensioners, 1818-1872*. Provo, UT, USA: Ancestry.com Operations Inc, 2007.
- Ancestry.com. *U.S., Find A Grave Index, 1600s-Current*. Provo, UT, USA: Ancestry.com Operations, Inc., 2012.
- Ancestry.com. *U.S., Find A Grave Index, 1600s-Current*. Provo, UT, USA: Ancestry.com Operations, Inc., 2012.
- Ancestry.com. *U.S., Newspaper Extractions from the Northeast, 1704-1930*. Provo, UT, USA: Ancestry.com Operations, Inc., 2014.
- Ancestry.com. *U.S., Social Security Applications and Claims Index, 1936-2007*. Provo, UT, USA: Ancestry.com Operations, Inc., 2015.
- Ancestry.com. *U.S., Sons of the American Revolution Membership Applications, 1889-1970*. Provo, UT, USA: Ancestry.com Operations, Inc., 2011.
- Ancestry.com. *Web: Connecticut, Find A Grave Index, 1636-2013*. Provo, UT, USA: Ancestry.com Operations, Inc., 2012.
- Ancestry.com. *Web: Illinois, Find A Grave Index, 1809-2012*. Provo, UT, USA: Ancestry.com Operations, Inc., 2012.
- Ancestry.com. *Web: Ohio, Find A Grave Index, 1787-2012*. Provo, UT, USA: Ancestry.com Operations, Inc., 2012.
- Ancestry.com. *Winnebago County, Illinois, Deaths, 1844-1992*. Provo, UT, USA: Ancestry.com Operations, Inc., 2013.

- Ancestry.com.. *Wisconsin, State Censuses, 1895 and 1905*. Provo, UT, USA: Ancestry.com Operations Inc, 2007.
- Barnstable Patriot*.
- Centennial Edition, Part 3, Page 2601. *DAR Patriot Index*.
- Dodd, Jordan, Liahona Research, comp. *Illinois Marriages, 1790-1860*. Provo, UT, USA: Ancestry.com Operations Inc, 2004.
- Dodd, Jordan, Liahona Research, comp. *Massachusetts, Marriages, 1633-1850*. Provo, UT, USA: Ancestry.com Operations Inc, 2005.
- Dodd, Jordan. *Illinois Marriages to 1850*. Provo, UT, USA: Ancestry.com Operations Inc, 1997.
- Edmund West, comp.. *Family Data Collection - Individual Records*. Provo, UT, USA: Ancestry.com Operations Inc, 2000.
- FamilySearch.org. *FamilySearch Family Tree*.
- Godfrey Memorial Library, comp.. *American Genealogical-Biographical Index (AGBI)*. Provo, UT, USA: Ancestry.com Operations Inc, 1999.
- Hatcher, Patricia Law. *Abstract of Graves of Revolutionary Patriots*. Provo, UT, USA: Ancestry.com Operations Inc, 1999.
- Heritage Consulting. *Millennium File*. Provo, UT, USA: Ancestry.com Operations Inc, 2003.
- Jordan Dodd and Liahona Research, comp.. *Illinois, Marriage Index, 1851-1900*. Provo, UT, USA: Ancestry.com Operations Inc, 2005.
- National Park Service. *U.S. Civil War Soldiers, 1861-1865*. Provo, UT, USA: Ancestry.com Operations Inc, 2007.
- National Society, Daughters of the American Revolution. *Daughters of the American Revolution Lineage Books (152 Vols.)*. Provo, UT, USA: Ancestry.com Operations, Inc., 2000.

Index of Places{ TC "Index of Places" \f C}

USA

Bosworth, Edy (1768-1851)...20

USA, Alabama

(32.7665° N, 86.8403° W)

Sears, D (1855-).....119
Sears, Mark A (1850-)119

USA, Alabama, Greene

(32.8548° N, 87.9513° W)

Sears, Albert Henry (1848-1909)
..... 118, 119

**USA, Alabama, Greene,
Clinton**

(32.9136° N, 87.9925° W)

Anthony, Martha Elizabeth
(1820-1890).....118
Sears, Albert Henry (1848-1909)
..... 118, 119
Sears, Jason G (1803-1873) .21,
117, 118
Sears, Mark A (1850-)119

USA, Alabama, Tuscaloosa

(33.2879° N, 87.5238° W)

Sears, Jason G (1803-1873) 118

**USA, California, Los
Angeles**

(34.1847° N, 118.262° W)

Sears, Edmund Hamilton (1852-
1942) 36, 132

**USA, California, Santa
Clara County, San Jose**

(37.3394° N, 121.8949° W)

Brewster, Esther (1818-1900)91
Sears, Henry (1815-1905).....90

USA, Connecticut

(41.5735° N, 72.7383° W)

Smith, Lucy (1775-1855)12

**USA, Connecticut,
Chatham**

Sears, Elijah Clark (1805-1910)
.....71

**USA, Connecticut,
Hartford County, West
Hartford**

(41.762° N, 72.742° W)

Sears, Selden Philo (1813-1900)
.....71

**USA, Connecticut,
Hartford, East Hartford**

(41.7823° N, 72.612° W)

Sears, Simeon (1776-1863)...93

**USA, Connecticut,
Hartford, East
Hartford, perh**

Spencer, Louisa (1777-1844).93

**USA, Connecticut,
Hartford, Enfield**

(41.9761° N, 72.5922° W)

Sears, Simeon (1776-1863) ..92

**USA, Connecticut,
Hartford, Marlborough**

(41.6314° N, 72.4603° W)

Bigelow, Ann (1773-1842).....76
Dickinson, Eveline (1813-)71
Sears, Selden Philo (1813-1900)
.....71

**USA, Connecticut,
Hartford, Marlborough,
perh**

Richmond, William Wadsworth
(1797-).....75

**USA, Connecticut,
Hartford, Simsbury**

(41.8758° N, 72.8017° W)

Hubbard, Samantha (1803-)..88
Slawter, Elizabeth (1741-1800)
.....50

**USA, Connecticut,
Hartford, Suffield**

(41.9817° N, 72.6511° W)

Granger, Rachel (1771-1846) 85

**USA, Connecticut,
Litchfield, Goshen**

(41.8317° N, 73.2256° W)

Baldwin, (1790-)..... 116

**USA, Connecticut,
Litchfield, New Milford**

(41.577° N, 73.4084° W)

Hitchcock, Samuel (1731-1801)
.....55
Sears, Sarah Lovisa (1822-1914)
.....96

**USA, Connecticut,
Litchfield, Winchester**

(41.9251° N, 73.1032° W)

Sears, Ellen Maria (1876-1963)
.....125, 126

**USA, Connecticut,
Litchfield, Winsted**

(41.9212° N, 73.0601° W)

Clark, Wallace W (1872-1944)
..... 126
Sears, Ellen Maria (1876-1963)
.....125, 126

**USA, Connecticut,
Middlesex, Chatham**

Bailey, Anna.....73
--Bailey, Hannah (1798-)74
Bailey, Job (1788-1847).....73
Bailey, Joshua (1803-1875)...73

Bailey, Lucy (1785-1862).....73
Bailey, Timothy74
Sears, Anna (1779-1854).....61
Sears, Benjamin (1771-1822)

..... 48, 75
Sears, Chauncey (1787-1881)61
Sears, Elijah Clark (1805-1910)

.....70
Sears, Elkanah (1734-1816)..47
Sears, Isaac.....64
Sears, Isaac (1757-1842) 47, 59
Sears, Lucy (-1879)62

Sears, Mary "Polly" (-1867) ...64
Sears, Ogden (1798-1883)....69
Sears, Selden Philo (1813-1900)
.....71

Sears, Stephen Griffith (1803-
1874).....70
Sears, Willard (1760-1838) ..47,
65, 69
Sears, Willard (1799-1866) ...69

**USA, Connecticut,
Middlesex, East
Hampton**

(41.5759° N, 72.5026° W)

Bailey, Joshua (1763-1853)...72
Clark, Betsy (1773-1831).....69
Sears, (1787-1787).....68
Sears, Betsey (1794-1833) ...62
Sears, Betsy (1797-1850).....69

Sears, Elkanah (1734-1816).42,
46
Sears, Eunice (1801-1875)....70
Sears, Isaac (1757-1842)60
Sears, Lucy (-1879)62

Sears, Rachel (1768-1850)...48,
74
Sears, Rachel (1794-1834)....68
Sears, Rhoda (1789-1859)....68
Sears, Stephen Griffith (1803-
1874).....70

Sears, Willard (1760-1838) ..47,
65
Veazey, Emily (1805-1879) ...70
White, Ruth (1733-1823)47
Young, Sally (1802-1838)70

**USA, Connecticut,
Middlesex, East
Hampton, Lakeside
Cemetery**

Sears, Elkanah (1734-1816)..46
Sears, Stephen Griffith (1803-
1874).....70
Sears, Willard (1760-1838) ...65
Young, Sally (1802-1838)70

**USA, Connecticut,
Middlesex, East
Hampton, perh**

Bailey, Clarissa (1800-1834) .75
Bailey, Harriet (1802-).....75
Bailey, Henry (1792-)74
Bailey, Rhoda (1766-1794) ...68
Bailey, Rhoda (1794-)75

- Clark, Betsy (1773-1831) 69
 Harding, Betsy (1803-) 69
- USA, Connecticut, Middlesex, Middle Haddam**
 (41.5539° N, 72.5506° W)
 Brainard, Jonathan (1784-) ... 73
- USA, Connecticut, Middlesex, Middletown**
 (41.5623° N, 72.6506° W)
 Mayo, Rebecca (1710-) 41
 Sears, Benjamin (1751-1831) 42
 Sears, Elkanah (1734-1816) .. 47
 Sears, Joshua (1708-1753) ... 40
 Sears, Ruth (1762-1764) 47
 Sears, Sarah (1746-1771) 55
 Sears, Theophilus (1749-1771) 42
 White, Ruth (1733-1823) 47
- USA, Connecticut, Middlesex, perh**
 Bailey, Nathaniel (1768-1817) 74
- USA, Connecticut, Middlesex, prob Chatham**
 Bailey, Lucy (1785-1862) 73
- USA, Connecticut, New Haven, New Haven**
 (41.3082° N, 72.9281° W)
 Munson, Harvey (1803-1848) 79
 Sears, Lucretia (1808-1894) . 78
- USA, Connecticut, New London**
 (41.4673° N, 72.1043° W)
 Sears, Isaac (1757-1842) 61
- USA, Connecticut, New London, Lyme**
 (41.3976° N, 72.3468° W)
 Watrous, Christopher (1782-1831) 62
- USA, Connecticut, New London, Norwich**
 (41.5243° N, 72.0759° W)
 Fitch, Ephraim (1768-1813) 102
 Sears, Henry (1815-1905) 90, 91
- USA, Connecticut, New London, Preston City**
 (41.5201° N, 72.0059° W)
 Brewster, Lucretia Tyler (1811-1854) 90
- USA, Connecticut, perh**
 Hills, Ann Bliss (1808-1875) .. 71
- USA, Connecticut, Tolland, Hebron**
 (41.6579° N, 72.3659° W)
- Phelps, Desiar (1794-1872) .. 77
- USA, Florida, Brevard, Cocoa**
 (28.3861° N, 80.742° W)
 Sears, Lucretia (1808-1894) . 78
- USA, Georgia**
 (32.7583° N, 82.5584° W)
 Anthony, Martha Elizabeth (1820-1890) 118
 Sanders, Florida Martha (ca.1850-) 119
- USA, Illinois**
 (39.7333° N, 88.5° W)
 Barlow, Henry (-1853) 96
 Sears, David Benton (1804-1884) 99
 Sears, David Granger (1806-1889) 88
- USA, Illinois, Gallatin**
 (37.758° N, 88.2294° W)
 Sears, Rebecca (1816-1884) 100
- USA, Illinois, Gallatin, Shawneetown**
 (37.7131° N, 88.1867° W)
 Sears, David Benton (1804-1884) 99
 Sears, Joseph (1774-1828) .. 53, 98
 Stokes, Melinda (1803-1835) 99
- USA, Illinois, Henry, western**
 Sears, Rebecca (1816-1884) 100
- USA, Illinois, Kane, Dundee**
 (42.0976° N, 88.2786° W)
 Sears, Sarah Lovisa (1822-1914) 96
- USA, Illinois, Lake, Lake Zurich**
 (42.197° N, 88.0934° W)
 Sears, John (1797-1856) 77
- USA, Illinois, McHenry, Crystal Lake**
 (42.2411° N, 88.3162° W)
 Hills, Ann Bliss (1808-1875) .. 71
- USA, Illinois, Rock Island, Moline**
 (41.5067° N, 90.5151° W)
 Caldwell, Delia (1813-1862) .. 99
 Sears, David Benton (1804-1884) 99
 Sears, Rebecca (1816-1884) 100
 Wood, Timothy (1810-1878) 101
- USA, Illinois, Rock Island, Sears**
 Sears, David Benton (1804-1884) 99
- Sears, Rebecca (1816-1884) 100
- USA, Illinois, Winnebago County, Rockford**
 (42.2711° N, 89.094° W)
 Daland, Eliza (1801-1868) 86
 Sears, Alfred (1795-1880) 86
- USA, Illinois, Winnebago, Rockford**
 (42.2711° N, 89.094° W)
 Brewster, Lucretia Tyler (1811-1854) 90
 Daland, Eliza (1801-1868) 86
 Sears, Alfred (1795-1880) 86
 Sears, David Granger (1806-1889) 89
- USA, Illinois, Winnebago, Rockford, Ward 2**
 Sears, David Granger (1806-1889) 89
- USA, Indiana**
 (39.775° N, 85.5584° W)
 Sears, Rebecca (1816-1884) 100
- USA, Indiana, Allen, Fort Wayne**
 (41.1306° N, 85.1289° W)
 Sears, Benjamin (1800-1822) 77
- USA, Iowa, Crawford County, Vail**
 (42.0619° N, 95.2° W)
 Pickett, Julia Louisa (1818-1885) 90
 Sears, Hiram (1811-1878) 90
- USA, Iowa, Crawford, Vail**
 (42.0619° N, 95.2° W)
 Sears, Hiram (1811-1878) 90
- USA, Iowa, Jackson County, Maquoketa**
 (42.0689° N, 90.6657° W)
 Wheat, Maria (1799-1875) 78
- USA, Iowa, Jackson, Maquoketa**
 (42.0689° N, 90.6657° W)
 Sears, David (1803-1870) 78
 Wheat, Maria (1799-1875) 78
- USA, Iowa, Polk, Des Moines, Ward 1**
 Sears, Henry D (1826-1914) 105
- USA, Kansas, Leavenworth**
 (39.2024° N, 95.0381° W)
 Hyde, Esther (1813-) 89
- USA, Kentucky**
 (37.825° N, 84.2333° W)
 Caldwell, Delia (1813-1862) .. 99

USA, Massachusetts

(42.1562° N, 71.5662° W)
 Bosworth, Clarissa Catherine
 (1810-1894).....25
 Sage, Jane Lucy (1846-1916)
124
 Sears, Jason (1873-)125

**USA, Massachusetts,
 Barnstable**

(41.7199° N, 70.2508° W)
 Bacon, Ellen (1811-1897).....36
 Sears, Edmund Hamilton (1810-
 1876)36

**USA, Massachusetts,
 Barnstable, Eastham**

(41.8301° N, 69.9739° W)
 Sears, Joshua (1708-1753) ...40

**USA, Massachusetts,
 Barnstable, Harwich**

(41.6862° N, 70.0758° W)
 Mayo, Rebecca (1710-)40
 Sears, Betsy (1738-1808)42, 48
 Sears, Elkanah (1734-1816) .41,
 45
 Sears, Hannah (1746-1802) ..56
 Sears, Joshua (1735/36-) 13, 42
 Sears, Paul (1740-1832) .42, 49
 Sears, Rebecca (1732-).....41
 Sears, Simeon (1742/43-1812)
42, 52
 Sears, Thomas (1744-)42
 Sears, Willard (-1754).....42

**USA, Massachusetts,
 Barnstable, Harwich,
 perh**

Knight, Lydia (Lyon) (1754-
 1850)50
 Sears, Sarah (1746-1771)42, 54

**USA, Massachusetts,
 Barnstable, Sandwich**

(41.759° N, 70.4939° W)
 Blackmore, Sarah (1744-1824)
14

**USA, Massachusetts,
 Barnstable, Yarmouth**

(41.7057° N, 70.2286° W)
 Sears, Joshua (1708-1753) ...39
 Sears, Rebecca (1732-).....41

**USA, Massachusetts,
 Berkshire County,
 Monterey**

(42.1793° N, 73.212° W)
 Sears, Norman Spencer (1805-
 1892)94

**USA, Massachusetts,
 Berkshire County,
 Sandisfield**

(42.1126° N, 73.1432° W)

Bosworth, Edy (1768-1851)...20
 Granger, Rachel (1771-1846) 85
 Sears, Joseph (1778-1851) ...11
 Sears, Joshua (1766-1836) ...18
 Sears, Joshua Milton (1808-
 1886).....25
 Sears, Paul Jr (1769-1851)...51,
 84

**USA, Massachusetts,
 Berkshire, Great
 Barrington**

(42.1959° N, 73.362° W)
 Sears, John R (1809-1883)....89

**USA, Massachusetts,
 Berkshire, Great
 Barrington, perh**

Hyde, Louisa (1813-).....89

**USA, Massachusetts,
 Berkshire, Monterey**

(42.1793° N, 73.212° W)
 Chapin, Calvin (1800-1855)...94
 Spear, Olive (1803-1878).....94

**USA, Massachusetts,
 Berkshire, Monterey,
 South Tyringham (now
 Monterey)**

Jones, Abigail (1803-1836)....94

**USA, Massachusetts,
 Berkshire, New
 Marlborough**

(42.1229° N, 73.2287° W)
 Chapin, Calvin (1800-1855)...94
 Hitchcock, Jerusha (1773-)...56,
 111
 Hitchcock, Reuben (1769-1824)
55, 110
 Hitchcock, Samuel (1734-)48
 Hitchcock, Silas (1771-)56
 Hyde, Esther (1813-).....89
 Sears, Hannah (1746-1802) .42,
 56
 Sears, Sarah (1746-1771)42, 55
 Sheldon, Benjamin (1779-1829)
57
 Sheldon, Elisha (1737-1799) .57
 Sheldon, Elisha (1778-)57

**USA, Massachusetts,
 Berkshire, Otis**

(42.1932° N, 73.0918° W)
 Spear, Olive (1803-1878).....94

**USA, Massachusetts,
 Berkshire, Sandisfield**

(42.1126° N, 73.1432° W)
 Bosworth, Clarissa Catherine
 (1810-1894).....25
 Bosworth, Edy (1768-1851)...20
 Clark, Wallace W (1872-1944)
126
 Deming, Olive (1806-1888) ...89
 Granger, Rachel (1771-1846) 85

Hurlburt, Mary "Polly" [Tryphena]
 (1777-1800).....92
 Jones, Abigail (1803-1836) ...94
 Knight, Lydia (Lyon) (1754-
 1850).....50
 Pickett, Julia Louisa (1818-1885)
90
 Sage, Jane Lucy (1846-1916)
124, 125
 Sears, Albert A (1792-1874)..20
 Sears, Alfred (1795-1880).....86
 Sears, Amos (1771-1861).....15
 Sears, Artemesia (1802-1849)
93
 Sears, Barnas (1802-1880) ...87
 Sears, Belinda (1798-1868) ..86
 Sears, Caleb (1764-1834).....14
 Sears, Catharine Bosworth
 (1840-1910).....26
 Sears, Daniel (1769-1853) ...14,
 19, 20
 Sears, Daniel (1801-1871) ...12,
 23
 Sears, David (1762-)14, 17
 Sears, David Granger (1806-
 1889).....88, 89
 Sears, Edmund Bacon (1843-
 1943).....26, 123, 124
 Sears, Edmund Hamilton (1810-
 1876).....12, 27
 Sears, Edward G (1813-1878)96
 Sears, Edy (1804-1805).....12
 Sears, Elizabeth (1763-) .50, 80
 Sears, Ellen Maria (1876-1963)
125, 126
 Sears, Emily B (1809-1886) ..95
 Sears, Esther (1782-)51, 97
 Sears, Helen Marcia (1833-1844)
26
 Sears, Henry (1815-1905)90
 Sears, Henry Morris (1808-1878)
21, 120, 121
 Sears, Hiram (1811-1878)90
 Sears, Huldah (1773-)51
 Sears, Jason (1873-)125
 Sears, Jason G (1803-1873) .20,
 117
 Sears, John (1779-)51
 Sears, John R (1809-1883) ...89
 Sears, Joseph (1778-1851) ..11,
 15
 Sears, Joshua (1735/36-) 13, 42
 Sears, Joshua (1766-1836) ..14,
 18, 19
 Sears, Joshua Milton (1808-
 1886).....12, 24, 25
 Sears, Julius (1807-1889)94, 95
 Sears, Lyman (1804-1866) ...88
 Sears, Marcus Aurelius (1796-
 1873).....20
 Sears, Mary (1776-)15
 Sears, Mary (1788-1872)85
 Sears, Mary (1790-1860).....17,
 113
 Sears, Mary (1806-1876)21
 Sears, Milton S (1868-).....125
 Sears, Nancy (1766-)50, 81
 Sears, Norman Spencer (1805-
 1892).....94
 Sears, Paul (1740-1832) .42, 49

Sears, Paul Jr (1769-1851) .. 51, 84, 85
 Sears, Polly Hurlburt (1800-1861) 92
 Sears, Rhoda (1761-1761).... 14
 Sears, Sally (1801-1880)..... 87
 Sears, Sara Elizabeth..... 122
 Sears, Sarah (1774-) 15
 Sears, Sarah (1788-1858) ... 17, 113
 Sears, Sarah (1794-)20, 116
 Sears, Sarah Elizabeth (1857-) 122
 Sears, Sarah Lovisa (1822-1914) 96
 Sears, Simeon (1776-1863) .51, 91
 Sears, Simeon (1811-1897) .95, 96
 Spencer, Louisa (1777-1844) 93

USA, Massachusetts, Berkshire, Sandisfield, perh
 Adams, Ann Eliza (1813-1848) 96
 Baldwin, (1816-)..... 116
 Baldwin, Laura (1818-)..... 116
 Barker, Mary A (1811-)..... 95
 Hawley, Gillette (1778-) 97
 Heath, Benjamin (1796-) 93
 Hurlburt, Mary "Polly" [Tryphena] (1777-1800) 92
 Ross, M (1805-)..... 23
 Sears, Daniel (1829-1899).... 24
 Sears, James Amos (1854-) 122
 Sears, Joseph (1827-1897) ... 23
 Sizer, Lemuel (1759-) 81

USA, Massachusetts, Berkshire, Stockbridge
 (42.2876° N, 73.3204° W)
 Sears, Emily B (1809-1886) .. 95

USA, Massachusetts, Berkshire, Tyringham
 (42.2459° N, 73.2037° W)
 Sears, Emily B (1809-1886) .. 95
 Sears, Joshua (1735/36-) 14

USA, Massachusetts, Berkshire, Tyringham, South Tyringham
 Sears, Norman Spencer (1805-1892) 94
 Thompson, Samuel (1805-1886) 95

USA, Massachusetts, Bristol, New Bedford
 (41.6362° N, 70.9342° W)
 Bolles, William (1798-1880) .. 87

USA, Massachusetts, Bristol, New Bedford, Ward 3
 Sears, Edmund Hamilton 2d (1878-1946) 129

USA, Massachusetts, Essex, Beverly
 (42.5584° N, 70.88° W)
 Endicott, Henry A Jr (1872-) 129

USA, Massachusetts, Essex, Newburyport
 (42.8126° N, 70.8773° W)
 Blackmore, Sarah (1744-1824) 14

USA, Massachusetts, Hampden, Granville
 (42.0668° N, 72.8615° W)
 Burt, James (1791-1874)..... 86

USA, Massachusetts, Hampden, Springfield
 (42.1015° N, 72.5898° W)
 Sears, Edward G (1813-1878)96

USA, Massachusetts, Hampshire, Easthampton
 (42.2668° N, 72.669° W)
 Sears, Ruth (1765-1830) .48, 72

USA, Massachusetts, Hampshire, Northampton
 (42.3251° N, 72.6412° W)
 Sheldon, Elisha (1737-1799) .57

USA, Massachusetts, Middlesex, Cambridge
 (42.3751° N, 71.1056° W)
 Sears, Barnas (1802-1880)... 88

USA, Massachusetts, Middlesex, Framingham
 (42.2793° N, 71.4162° W)
 Sears, Hannah (1746-1802).. 57
 Sheldon, Benjamin (1779-1829) 57

USA, Massachusetts, Middlesex, Marlborough
 (42.3459° N, 71.5523° W)
 Hitchcock, Ebenezer (1767-1834) 55, 109

USA, Massachusetts, Middlesex, Medford
 (42.4184° N, 71.1062° W)
 Bennett, Sophia Whitney (1883-1980) 130

USA, Massachusetts, Middlesex, Stoneham
 (42.4801° N, 71.0995° W)
 Sears, Dexter C (1834-1907) 106

USA, Massachusetts, Middlesex, Wayland
 (42.3626° N, 71.3614° W)
 Bennett, Sophia Whitney (1883-1980)130
 Buckingham, Leslie (1883-1911)129
 Sears, Edmund Hamilton 2d (1878-1946)129
 Sears, Francis Bacon (1849-1914) 36, 127
 Sears, Horace Scudder (1855-1923) 37
 Sears, Katharine "Katy" (1843-1853) 36

USA, Massachusetts, Middlesex, Wayland, perh
 Sears, Edmund Hamilton (1852-1942) 36, 132

USA, Massachusetts, Middlesex, Westford
 (42.5793° N, 71.4379° W)
 Carter, Ezra (1774-1855) 61
 Sears, Anna (1779-1854) 61

USA, Massachusetts, Middlesex, Weston
 (42.3668° N, 71.3031° W)
 Bacon, Ellen (1811-1897) 36
 Sears, Edmund Hamilton (1810-1876) 12, 27
 Sears, Edmund Hamilton 2d (1878-1946)129
 Sears, Francis Bacon (1849-1914)127
 Sears, Horace Scudder (1855-1923) 37
 Sears, Jackson Knyvet (1881-1905)131
 Sears, Katharine "Katy" (1843-1853) 36
 Sears, Katharine M (1876-)..128

USA, Massachusetts, Middlesex, Wilmington
 (42.5465° N, 71.1737° W)
 Carter, Ezra (1774-1855) 61
 Sears, Anna (1779-1854) 61

USA, Massachusetts, Norfolk, Brookline
 (42.3318° N, 71.1211° W)
 Buckingham, Leslie (1883-1911)129
 Corey, Elizabeth Griggs (1809-1883) 88
 Sears, Barnas (1802-1880)... 88

USA, Massachusetts, Plymouth, Scituate, West Scituate
 Collamore, Betsy (1807-1880) 96
 Sears, Edward G (1813-1878)96

**USA, Massachusetts,
Plymouth, Wareham**
(41.7626° N, 70.7217° W)
Sears, Francis Bacon (1849–
1914).....128

**USA, Massachusetts,
Suffolk, Boston**
(42.3583° N, 71.0603° W)
Sears, Jackson Knyvet (1881–
1905).....131
Sears, Katharine M (1876–) .128
Sparhawk, Mary Elizabeth
(1847–1923).....128

**USA, Massachusetts,
Suffolk, Boston, Ward
11**
Sears, Edmund Hamilton 2d
(1878–1946).....129
Sears, Francis Bacon (1849–
1914).....128
Sears, Katharine M (1876–) .128
Sparhawk, Mary Elizabeth
(1847–1923).....128

**USA, Massachusetts,
Suffolk, Brighton**
(42.35° N, 71.1569° W)
Sears, Edmund Hamilton 2d
(1878–1946).....129
Sears, Francis Bacon Jr (1882–
1943).....131

**USA, Massachusetts,
Worcester, Lancaster**
(42.4557° N, 71.6731° W)
Sears, Katharine "Katy" (1843–
1853).....36

USA, Michigan
(44.5917° N, 85.025° W)
Bailey, Lucy (1785–1862)73

**USA, Michigan, Kent,
Algoma**
(43.1667° N, 85.6083° W)
Fitch, Joseph H (1819–1873) 104

**USA, Michigan, Kent,
Cascade**
(42.9122° N, 85.4981° W)
Sears, Chauncey (1787–1881)62

**USA, Michigan, Oakland,
Milford**
(42.5936° N, 83.5994° W)
Fitch, Joseph Jr (–1840)104

**USA, Michigan, Wayne,
Detroit**
(42.3314° N, 83.0458° W)
Slater, Mary Ann (1798–1871)77

**USA, Minnesota, Fillmore,
Fountain**
(43.74° N, 92.1363° W)

Sears, Sally (1801–1880)87

**USA, Minnesota, Fillmore,
Winslow Cemetery**
Bolles, William (1798–1880) ..87

USA, Mississippi
(32.6083° N, 89.1° W)
Peatock, Julia A (1851–1934)
..... 119

**USA, Mississippi,
Covington**
(31.632° N, 89.5519° W)
Sears, Albert Henry (1848–1909)
..... 118

**USA, Mississippi,
Covington, Ora**
(31.6577° N, 89.5745° W)
Peatock, Julia A (1851–1934)
..... 119

**USA, Mississippi, Jasper,
Missionary**
Sears, Albert Henry (1848–1909)
..... 119

USA, New Hampshire
(43.6855° N, 71.5776° W)
Sears, Simeon (1811–1897) ..96

**USA, New Hampshire,
Sullivan, Lempster**
(43.2384° N, 72.2107° W)
Sears, Simeon (1811–1897) ..96

**USA, New Jersey, Atlantic,
Hammonton**
(39.6365° N, 74.8024° W)
Sears, Julius (1807–1889)95

**USA, New Jersey,
Cumberland, Landis**
(39.3746° N, 74.9638° W)
Sears, Julius (1807–1889)95

**USA, New Jersey,
Cumberland, Vineland**
(39.4862° N, 75.0257° W)
Sears, Julius (1807–1889)95

**USA, New Jersey, Essex,
Orange**
(40.7707° N, 74.2326° W)
Sears, Mary (1788–1872)85

**USA, New Jersey, Essex,
West Orange**
(40.7987° N, 74.2391° W)
Sears, Mary (1788–1872)85

**USA, New Jersey, Hudson,
Jersey City**
(40.7282° N, 74.0777° W)
Sears, David Granger (1806–
1889).....89

USA, New York
(42.7531° N, 74.2224° W)
Daily, Nancy (ca.1843–)..... 105
Fitch, Joseph H (1819–1873) 104
Frisbie, Elizabeth (1819–)..... 79
Mitchell, Jennette (1807–1871)
..... 78
Scott, Betty O (1844–)..... 106
Sears, Henry D (1826–1914) 105
Sears, John (1797–1856) 77
Sears, Mary Edia (1867–) 122
Sears, Sally (1793–)..... 62
Wheeler, Mary E (1825–)..... 121

USA, New York, Albany
(42.6029° N, 73.9717° W)
Sears, Isaac (1757–1842) 61

**USA, New York, Albany,
Cohoes**
(42.7742° N, 73.7001° W)
Bailey, Joshua (1763–1853)...73

USA, New York, Cayuga
(42.9448° N, 76.5614° W)
Rhodes, David (1755–1839) 111

USA, New York, Chemung
(42.1409° N, 76.76° W)
Sears, Eda..... 122

**USA, New York, Chemung,
Veteran**
(42.2498° N, 76.7877° W)
Sears, Henry Morris (1808–1878)
..... 121
Sears, Sarah Elizabeth (1857–)
..... 122
Sears, Susy E (ca.1858–) 122
Wheeler, Mary E (1825–)..... 121,
122

USA, New York, Delaware
(42.2008° N, 74.9648° W)
Sears, Hiram (1811–1864) 79

**USA, New York, Delaware,
Meredith**
(42.3583° N, 74.9348° W)
Bailey, Darby (1801–)..... 73
Bailey, Joshua (1803–1875)...73
Sears, David (1803–1870)..... 77
Sears, Hiram (1811–1864) 79
Sears, Lucretia (1808–1894).. 78
Sears, Orin (1805–1886)..... 78
Sears, Rufus (1817–1842)..... 79
Sears, Ruth (1765–1830) 48, 72

**USA, New York, Delaware,
Meredith, perh**
Tuttle, Phidelia (1813–1843)..79

USA, New York, Dutchess
(41.7645° N, 73.7472° W)
Shufelt, Johannes (1787–<1850)
..... 64

- USA, New York, Dutchess County, Poughkeepsie**
(41.7004° N, 73.921° W)
Sears, John R (1809–1883) ... 89
- USA, New York, Dutchess, Amenia**
(41.8493° N, 73.5568° W)
Wood, Timothy (1810–1878) 101
- USA, New York, Dutchess, Poughkeepsie**
(41.7004° N, 73.921° W)
Sears, John R (1809–1883) ... 89
- USA, New York, Dutchess, Rhinebeck**
(41.9268° N, 73.9126° W)
Slater, Mary Ann (1798–1871) 77
- USA, New York, Franklin**
(44.6003° N, 74.3091° W)
Sears, Elkanah (1795–1886) .. 77
- USA, New York, Genesee County, Le Roy**
(42.9784° N, 77.9842° W)
Adams, Ann Eliza (1813–1848) 96
- USA, New York, Genesee, Bethany**
(42.9087° N, 78.1342° W)
Ashley, Fidelia F (1812–1853) 107
Curtiss, Ephraim Fitch (1813–1900) 107
- USA, New York, Greene, Durham**
(42.3994° N, 74.1728° W)
Sears, Betsey (1794–1833) ... 62
Sears, Lucy (-1879) 62
Watrous, Christopher (1782–1831) 62
- USA, New York, Greene, Durham, New Durham**
Sears, Benjamin (1800–1822) 77
- USA, New York, Greene, Durham, Stone Bridge Cemetery**
Sears, Lucy (-1879) 62
Stilwell, Vincent (1790–1880) 62
Watrous, Christopher (1782–1831) 63
- USA, New York, Greene, East Durham**
(42.3725° N, 74.0961° W)
Sears, Betsey (1794–1833) ... 62
- USA, New York, Greene, New Durham**
Daniels, Grace (1764–1843) .. 61
Sears, Elkanah (1795–1886) .. 76
- USA, New York, Herkimer, Frankfort**
(43.039° N, 75.0704° W)
Hitchcock, Ebenezer (1767–1834) 55, 109
- USA, New York, Herkimer, Litchfield Twp**
(42.9776° N, 75.1507° W)
Hitchcock, Betsy (1794–1819) 110
Hitchcock, Electa (1799–1879) 110
Hitchcock, Ira Irvine (1793–1868) 109
Hitchcock, Julia Ann (1804–) 110
- USA, New York, Kings**
(40.6358° N, 73.9506° W)
Burt, James (1791–1874)..... 86
- USA, New York, Kings, Brooklyn**
(40.65° N, 73.95° W)
Burt, James (1791–1874)..... 86
Sears, Hiram (1811–1878) 90
Sears, Lyman (1804–1866) ... 88
Sears, Mary (1788–1872)..... 85
- USA, New York, Kings, Brooklyn, green-wood cemetary**
Hubbard, Samantha (1803–) . 88
- USA, New York, Kings, Brooklyn, Ward 6**
Sears, Lyman (1804–1866) ... 88
- USA, New York, Livingston, Avon**
(42.912° N, 77.7456° W)
Curtiss, William Sears (1810–1883) 107
- USA, New York, Livingston, Avon New Methodist Cemetery**
Sears, Laura (1790–1839)... 106
- USA, New York, Livingston, Avon, Lima Cemetery**
Curtiss, William Sears (1810–1883) 107
- USA, New York, Livingston, Genesee**
(42.7959° N, 77.817° W)
Ashley, Fidelia F (1812–1853) 108
Curtiss, Ephraim Fitch (1813–1900) 107
- USA, New York, Livingston, Genesee, Temple Hill Cemetery**
Curtiss, Ephraim Fitch (1813–1900) 107
- USA, New York, Livingston, Lima**
(42.9048° N, 77.6114° W)
Sears, David Benton (1804–1884) 98
- USA, New York, Livingston, Lima, perh**
Pitts, Sarah (1779–1843)..... 98
Sears, (1808–1812) 99
Sears, (1810–1812) 99
Sears, Chauncy (1806–1812) 99
Sears, Deborah (1816–1886) 100
Sears, Polly (1812–1882)..... 100
- USA, New York, New Durham**
Sears, Chauncey (1787–1881) 62
Sears, Isaac (1757–1842) 47, 60
Sears, John (1797–1856) 77
Shufeldt, Sally (1797–)..... 62
- USA, New York, Oneida, Camden**
(43.3345° N, 75.748° W)
Sears, Elijah Clark (1805–1910) 71
- USA, New York, Oneida, Paris**
(43.0006° N, 75.3142° W)
Daland, Eliza (1801–1868) 86
Hitchcock, Horace Curtis (1822–) 110
- USA, New York, Oneida, Vernon**
(43.0795° N, 75.5393° W)
Hitchcock, Reuben (1769–1824) 56, 110
- USA, New York, Orleans, Albion, Mt Albion Cemetery**
Sears, Ogden (1798–1883) ... 69
- USA, New York, Orleans, Barre**
(43.1684° N, 78.217° W)
Sears, Ogden (1798–1883) ... 69
- USA, New York, Orleans, Barre, South Barre**
Sears, Ogden (1798–1883) ... 69
- USA, New York, Oswego, Granby**
(43.2923° N, 76.44° W)
Sears, Mary "Polly" (-1867) .. 64
- USA, New York, Saratoga**
(43.1059° N, 73.8677° W)

Sears, Barnas (1802–1880) ...88	Curtiss, William Sears (1810–1883)..... 107	Sears, Julius (1807–1889) 95
USA, New York, Saratoga, Waterford (42.7926° N, 73.6812° W)	USA, Ohio, Crawford, Bucyrus (40.8084° N, 82.9755° W)	USA, Pennsylvania, Indiana, Purchase Line Sears, Simeon (1776–1863) ..91
Bailey, Joshua (1803–1875) ...73	Phelps, Desiar (1794–1872) ...77	USA, Pennsylvania, Philadelphia (40.0068° N, 75.1347° W)
USA, New York, Schuyler, Hector (42.5006° N, 76.8728° W)	Sears, Benjamin (1771–1822) 76	Hitchcock, Ira Irvine (1793–1868)..... 109
Bigelow, Ann (1773–1842).....76	Sears, Elkanah (1795–1886) ..76	USA, Pennsylvania, Washington (40.1888° N, 80.2478° W)
Mitchell, Jennette (1807–1871)78	USA, Ohio, Cuyahoga, Rockport, East Rockport Sears, Elkanah (1795–1886) ..76	Truesdale, Robinson (1801–1867)..... 87
Sears, Orin (1805–1886)78	USA, Ohio, Delaware (40.2783° N, 83.0074° W)	USA, South Dakota, Lincoln (43.2794° N, 96.7219° W)
USA, New York, Schuyler, Mecklenburg (42.4575° N, 76.7106° W)	Sears, Benjamin (1771–1822) 48, 76	Sears, Elijah Clark (1805–1910) 70
Bigelow, Ann (1773–1842).....76	USA, Ohio, Geauga (41.4988° N, 81.1725° W)	USA, South Dakota, Lincoln County, Canton (43.3008° N, 96.5925° W)
USA, New York, Schuyler, Mecklenburg, near Sears, Orin (1805–1886)78	Sears, Marcus Aurelius (1796–1873).....20	Sears, Elijah Clark (1805–1910) 70
USA, New York, Seneca, Ovid (42.6765° N, 76.823° W)	USA, Ohio, Geauga County, Chesterland (41.5223° N, 81.3379° W)	USA, South Dakota, Lincoln, Canton (43.3008° N, 96.5925° W)
Hitchcock, Jerusha (1773–) ...56, 111	Sears, Albert A (1792–1874) ..20	Sears, Elijah Clark (1805–1910) 71
USA, New York, St Lawrence (44.5785° N, 75.2597° W)	Sears, Marcus Aurelius (1796–1873).....20	USA, South Dakota, Lincoln, Canton Ward 2 Sears, Elijah Clark (1805–1910) 71
Sears, Daniel (1785–1851) ...54, 104	USA, Ohio, Geauga, Chester, Chester Center Sears, Albert A (1792–1874) ..20	USA, Vermont (43.8726° N, 71.55° W)
USA, New York, St Lawrence, Gouverneur (44.3367° N, 75.463° W)	USA, Ohio, Lorain (41.4662° N, 82.1542° W)	Sears, Daniel (1785–1851) ...53, 104
Sears, Daniel (1785–1851) ..105	Fitch, Nancy (1799–1860) ... 102	USA, Vermont, Bennington (43.0293° N, 73.1084° W)
Sears, Dexter C (1834–1907)105	USA, Ohio, Mahoning, Youngstown (41.1009° N, 80.64° W)	Pengra, Clarissa Lucinda (1815–) 107
USA, New York, Steuben, Bath (42.337° N, 77.3177° W)	Sears, Belinda (1798–1868) ...86	Sears, Rhoda (1776–1854) ...53, 101
Sears, Rufus (1817–1842)79	Truesdale, Robinson (1801–1867)..... 87	USA, Vermont, Bennington, perh Sears, Daniel (1772–) 53
USA, New York, Ulster, Marlboro (41.6057° N, 73.9715° W)	USA, Pennsylvania (40.8583° N, 76.3834° W)	Sears, Elisha (1770–)..... 53
Wheat, Maria (1799–1875)78	Sears, Simeon (1776–1863) .51, 91	Sears, Joseph (1774–1828) ..53, 98
USA, New York, Washington, Granville (43.4079° N, 73.2595° W)	USA, Pennsylvania, Bradford, Athens (41.9573° N, 76.518° W)	--Sears, Sarah (1746–1794) ..53
Fitch, Moses Porter (1811–) .103	Thompson, Samuel (1805–1886)95	Sears, Simeon (1768–) 53
USA, New York, Washington, Granville, perh Cook, Chloe Atwater (1819–)103	USA, Pennsylvania, Bucks, Warwick (40.1642° N, 75.7859° W)	USA, Vermont, Bennington, Pownal, perh --Sears, Sarah (1746–1794) ..53
USA, New York, Washington, Salem (43.1723° N, 73.3276° W)	Rapp, Herbert Smith (1809–1880)..... 108	
	USA, Pennsylvania, Indiana, Green (41.5333° N, 79.3664° W)	

USA, Vermont, Franklin, St Albans
(44.8108° N, 73.0836° W)
Collamore, Betsy (1807–1880)
..... 96

USA, Vermont, Rutland
(43.5742° N, 73.035° W)
Fitch, George (1801–)..... 103
Fitch, Nancy (1799–1860) ... 102

USA, Vermont, Rutland, Pawlet
(43.3467° N, 73.1767° W)
Curtiss, Emaline (1813–)..... 107
Curtiss, Ephraim Fitch (1813–
1900) 107
Curtiss, Sarah Ann (1814–1880)
..... 108

Curtiss, William Truman (1786–
1820) 107
Fitch, Ephraim (1768–1813) 102
Fitch, Moses Porter (1811–). 103
Sears, Laura (1790–1839).... 54,
106
Sears, Rhoda (1776–1854)... 53,
101, 102
Willard, James (–1858) 102

USA, Vermont, Rutland, Pawlet, perh
Fitch, Catharine (1805–) 103
Fitch, Catharine (1807–) 103
Fitch, Ferris (1802–) 103
Sears, Betsy (1792–1862)..... 54
Sears, Mary (1794–)..... 54

USA, Virginia
(38.0667° N, 78.5833° W)

Sears, Polly Hurlburt (1800–
1861) 92

USA, Virginia, Augusta, Staunton
(38.1496° N, 79.0717° W)
Corey, Elizabeth Griggs (1809–
1883) 88

USA, Wisconsin, Green Lake, Berlin
(43.968° N, 88.9435° W)
Sears, Henry D (1826–1914) 105

USA, Wisconsin, Sheboygan, Black River
(43.6949° N, 87.7113° W)
Sears, Rebecca (1816–1884) 100

Index of Individuals { TC "Index of Individuals" \f C }

Adams Ann Eliza (1813-1848) 96	Bigelow Ann (1773-1842) 75, 76 David (1732-) 75, 76	Corey Elizabeth Griggs (1809-1883) . 88 Timothy (1783-) 88
Andrus Mary..... 102, 103, 104	Bishop Melinda..... 109	Crocker Abigail (1789-) .. 27, 36, 127, 132
Anthony Martha Elizabeth (1820-1890) 117, 118	Blackmore Sarah (1744-1824).... 11, 13, 14, 17, 18, 19, 20, 23, 24, 27, 113, 114, 115, 116, 117, 120	Curtis Eldad (1732-1814) 106, 107
Arnold Harvey 69	Bolles Mary (-1839) 78 William (1798-1880)..... 87	--Curtis Ariminta 107
Ashley Abner 107 Clarissa L (-1873)..... 108 Fidelia F (1812-1853) 107	Bosworth Clarissa Catherine (1810-1894) 24, 25, 123 Edy (1768-1851)..... 19, 20, 116, 117, 120 Jabez 24, 25, 123	Curtiss Child (1815-1815)..... 106, 108 Emaline (1813-)..... 106, 107 Ephraim Fitch (1813-1900) .. 106, 107 Fanny F (1820-)..... 106, 108 Laura (1818-)..... 106, 108 Mary Ann (1816-) 106, 108 Sarah Ann (1814-1880) 106, 108 William Sears (1810-1883)... 106, 107 William Truman (1786-1820) 106
ASHLEY Clarissa Louise (Fidelia F. Ashley) (1812-1853)..... 107	Brainard Jonathan (1784-) 73	Daily Nancy (ca.1843-) 105
Austin Elizabeth..... 94	Breed Adin 109 Alin 110	Daland Eliza (1801-1868) 86
Avery Anson 87	Brewster Erastus (1775-1832) 90, 91 Esther (1818-1900)..... 91 Lucretia Tyler (1811-1854)..... 90	Daniels Grace (1764-1843)..... 59, 61 Nehemiah or Jonathan..... 59, 61
Bacon Ebenezer (1756-1811) 27, 36, 127, 132 Ellen (1811-1897) ... 27, 36, 127, 132	Brown Bessie 107	Davis Luman..... 87
Bailey (1737-) 72, 74 Anna 72, 73 Clarissa (1800-1834) 74, 75 Darby (1801-)..... 72, 73 Harriet (1802-) 74, 75 Harry (1799-1839) 72, 73 Henry (1792-)..... 74 Ira (1794-1830) 72, 73 Job (1788-1847) 72, 73 John G (1790-) 72, 73 Joshua (1763-1853) 72 Joshua (1803-1875) 72, 73 Lucy (1785-1862)..... 72, 73 Nathaniel (1768-1817)..... 74 Rhoda (1766-1794) 67, 68 Rhoda (1794-) 74, 75 Timothy 72, 74	Buckingham Leslie (1883-1911) 129 Marian (1881-1943) 131	Deland Philip..... 86
--Bailey Bethana (1794-1849) 73	Burt James (1791-1874) 86	Deming Olive (1806-1888)..... 89
--Bailey Hannah (1798-) 74	Caldwell Delia (1813-1862)..... 99	Dickinson Eveline (1813-)..... 71
Baldwin (1790-) 116 (1816-) 116 Laura (1818-) 116	Calvin Belina..... 107	Endicott Henry 129 Henry A Jr (1872-) 128
Barker Mary A (1811-) 95	Carter Ezra (1774-1855)..... 61 Sarah Elinor Douglass (1831- 1908)..... 107	Everett Elizabeth 109 John..... 109
Barlow Henry (-1853)..... 96	Chapin Calvin (1800-1855) 94 Peter..... 94	Fitch Catharine (1805-) 102, 103 Catharine (1807-) 102, 103 Ephraim (1768-1813) 102 Ferris (1802-)..... 102, 103 George (1801-)..... 102, 103 Joseph..... 102, 103, 104 Joseph H (1819-1873) .. 103, 104 Joseph Jr (-1840)..... 103, 104 Moses Porter (1811-).... 102, 103 Nancy (1799-1860) 102
Bennett Sophia Whitney (1883-1980) 130	Clark Betsy (1773-1831) 68, 69 Nathaniel Mattoon (1822-1887) 126 Wallace W (1872-1944) 126	Foster Patience (1751-) 75, 76
	Collamore Betsy (1807-1880) 96	
	Cook Chloe Atwater (1819-) 103	

Freeman

Mercy (1674-1747) *13, 39, 40, 45, 48, 49, 50, 52, 54, 56*
 Thomas (1653-1715/16)..... 39

Frisbie

Elizabeth (1819-).....**79**

Gamble

Emily 114
 Isaac **114**
 Mary 114

Gasner

George.....**97**

Gill

Elizabeth 109

Granger

David *84, 85*
 Rachel (1771-1846) **84, 85**

Griggs

Elizabeth (1787-)..... 88

Handy

Cyrenus **81, 83**

Harding

Betsy (1803-).....**69**
 Daniel (1777-)..... 69

Hawley

Eunice Ann 97
 Gillette (1778-).....**97**

Heath

Benjamin (1796-) **93**

Hillard

Esther (-1826)..... *90, 91*

Hills

Ann Bliss (1808-1875).....**71**
 David 71

Hitchcock

Betsy (1794-1819)..... 109, **110**
 Ebenezer (1767-1834).....*54, 55, 109*
 Electa (1799-1879) 109, **110**
 Horace Curtis (1822-)... 109, **110**
 Ira Irvine (1793-1868) 109
 Jerusha (1773-).....*54, 56, 111*
 Julia Ann (1804-)..... 109, **110**
 Nancy (1794-1830)..... 109
 Reuben (1769-1824) .*54, 55, 110*
 Samuel (1699-1774) *54, 55, 109, 110, 111*
 Samuel (1731-1801) **54, 55, 109, 110, 111**
 Samuel (1734-) **48**
 Silas (1771-) *54, 56*

--Hitchcock

Deborah 54

--Hitchcock

Deborah 55

--Hitchcock

Deborah 109

--Hitchcock

Deborah 110

--Hitchcock

Deborah 111

Hubbard

Immar **115**
 Samantha (1803-) **88**

Hurlburt

Mary "Polly" [Tryphena] (1777-1800) **92**

Hyde

Esther (1813-) **89**
 Louisa (1813-)..... **89**

Jackson

(unknown given name) **100**
 Mary Susannah *127, 128*

Jones

Abigail (1803-1836) **94**

Kilborn

Esther 73

Knight

Lydia (Lyon) (1754-1850) .**49, 50**

Knowles

Barbary (1656-1715) 39

Lane

Roswell (1778-1870)..... **111**

Lawrence

Sibble *84, 85*

Lee

William L **100**

Mayo

Rebecca (1710-)...*11, 13, 17, 18, 19, 39, 40, 45, 46, 48, 49, 50, 52, 54, 56, 59, 67, 68, 72, 74, 75, 80, 81, 84, 92, 93, 97, 98, 102, 103, 104, 106, 109, 110, 111*
 Theophilus (1680-1763) ...*13, 39, 40, 45, 48, 49, 50, 52, 54, 56*
 Thomas (1650-1729) 39

Miller

Almira (1804-1862) **73**
 William..... **73**

Mitchell

Jennette (1807-1871) **78**

Munson

Harvey (1803-1848) **79**

Newkirk

Maritje 64

Peatock

Julia A (1851-1934) **119**

Pengra

Clarissa Lucinda (1815-)..... **107**
 William..... 107

Phelps

Arminda (1772-)..... 77

Desiar (1794-1872) **77**
 Obadiah (1768-)..... 77

Pickett

Julia Louisa (1818-1885) **90**
 Samuel 90

Pitts

Peter (1736-1812) 98
 Sarah (1779-1843) **98**

Porter

Sally **103**

Rapp

Herbert Smith (1809-1880) .. **108**
 Jackson..... **108**

Rector

John **110**

Rhodes

David (1755-1839) **111**
 Jerusha (1802-1877) 111

Richmond

Abigail (1744-) 98
 John 75
 William Wadsworth (1797-) **75**

Robert

Henry **75**

Ross

M (1805-) **23**

Rumsey

Polly *107*

Sage

Emily Ann (1829-1915) *126*
 Jane Lucy (1846-1916) **123, 124**

Sanders

Florida Martha (ca.1850-) **119**

Sayles

Eunice Grant..... **99**

Scott

Betty O (1844-)..... **106**
 Cynthia **104, 105**

Sears

(1787-1787) 67, **68**
 (1791-) 59, **62**
 (1808-1812) 98, **99**
 (1810-1812) 98, **99**
 Albert A (1792-1874) 19, **20**
 Albert Henry (1848-1909).....*117, 118*
 Alfred (1795-1880) 84, **86**
 Amos (1771-1861) 13, **15**
 Anna (1779-1854) 59, **61**
 Artemesia (1802-1849) 93
 Barnas (1802-1880)..... 84, **87**
 Belinda (1798-1868) 84, **86**
 Benjamin (1751-1831) 39, **42**
 Benjamin (1771-1822) 45, 48, **75**
 Benjamin (1800-1822) 75, **77**
 Betsey (1794-1833) 59, **62**
 Betsy (1738-1808) 39, 42, **48**
 Betsy (1792-1862) 52, **54**
 Betsy (1797-1850) 68, **69**
 Caleb (1764-1834) 13, **14**

Catharine Bosworth (1840-1910)24, **26**
 Chauncey (1787-1881)59, **61**
 Chauncy (1806-1812)98, **99**
 Cynthia (1811-) 104, **105**
 D (1855-).....117, **119**
 Daniel (1769-1853) ... 13, 14, **19**,
 116, 117, 120
 Daniel (1772-)52, **53**
 Daniel (1785-1851) .. 52, 53, **104**
 Daniel (1801-1871) 11, 12, **23**
 Daniel (1829-1899)23, **24**
 David (1762-) 13, 14, **17**, 113,
 114, 115
 David (1803-1870)75, **77**
 David (Daniel Sears) (1785-1851)
 54, 104
 David Benton (1804-1884)98
 David Granger (1806-1889)....84,
88
 Deborah (1816-1886)98, **100**
 Dexter C (1834-1907)... 104, **105**
 Eda120, **122**
 Edmund Bacon (1843-1943) ...24,
 26, **123**
 Edmund Hamilton (1810-1876)
 11, 12, **27**, 127, 132
 Edmund Hamilton (1852-1942)
 27, 36, **132**
 Edmund Hamilton 2d (1878-1946)
 127, **129**
 Edward G (1813-1878).....93, **96**
 Edy (1804-1805).....11, **12**
 Elijah Clark (1805-1910) ...68, **70**
 Elisha (1770-)52, **53**
 Elizabeth (1763-)50, **80**
 Elkanah (1734-1816) .39, 41, **45**,
 59, 60, 65, 67, 68, 72, 74, 75,
 76
 Elkanah (1795-1886)75, **76**
 Ellen Maria (1876-1963) 123, **125**
 Emily B (1809-1886)93, **95**
 Esther (1782-) 50, 51, **97**
 Eunice (1801-1875)68, **70**
 Francis Bacon (1849-1914)27, 36,
127
 Francis Bacon Jr (1882-1943)127,
131
 Frederic (1792-).....18, **19**
 Hannah (1746-1802) .. 39, 42, **56**
 Harvey (1794-)18, **19**
 Helen Marcia (1833-1844) .24, **26**
 Henry (1815-1905).....84, **90**
 Henry D (1826-1914).... 104, **105**
 Henry Morris (1808-1878) 19, 21,
120
 Hiram (1811-1864).....75, **79**
 Hiram (1811-1878).....84, **90**
 Horace Scudder (1855-1923) ..27,
37
 Huldah (1773-)50, **51**
 Isaac59, **64**
 Isaac (1757-1842)..... 45, 47, **59**
 Jackson Knyvet (1881-1905) 127,
131
 James Amos (1854-)..... 120, **122**
 Jason (1873-) 123, **125**
 Jason G (1803-1873) 19, 20, **117**
 John (1779-).....50, **51**
 John (1797-1856).....75, **77**

John (John Sears) (1797-1856)77
 John R (1809-1883)84, **89**
 Joseph (1774-1828) ... 52, 53, **98**
 Joseph (1778-1851) .. **11**, 13, 15,
 23, 24, 27, 123, 127, 132
 Joseph (1827-1897)23
 Joshua (1708-1753) ...11, 13, 17,
 18, 19, **39**, 45, 46, 48, 49, 50,
 52, 54, 56, 59, 67, 68, 72, 74,
 75, 80, 81, 84, 92, 93, 97, 98,
 102, 103, 104, 106, 109, 110,
 111
 Joshua (1735/36-)11, **13**, 17, 18,
 19, 20, 23, 24, 27, 39, 42, 113,
 114, 115, 116, 117, 120
 Joshua (1766-1836) ... 13, 14, **18**
 Joshua Milton (1808-1886)11, 12,
24, 123
 Julius (1807-1889)93, **94**
 Katharine "Katy" (1843-1853) 27,
36
 Katharine M (1876-) 127, **128**
 Laura (1790-1839) ... 52, 54, **106**
 Lucretia (1808-1894).....75, **78**
 Lucy (-1879)59, **62**
 Lyman (1804-1866).....84, **88**
 Marcus Aurelius (1796-1873) ..19,
20
 Mark A (1850-) 117, **119**
 Mary "Polly" (-1867)59, **64**
 Mary (1776-) 13, **15**
 Mary (1788-1872)84, **85**
 Mary (1790-1860) .17, **113**, **114**,
115
 Mary (1794-)52, **54**
 Mary (1806-1876) 19, **21**
 Mary Edia (1867-) 120, **122**
 Milton S (1868-)..... 123, **125**
 Nancy (1766-)50, **81**
 Norman Spencer (1805-1892) 93,
94
 Ogden (1798-1883).....68, **69**
 Orin (1805-1886)75, **78**
 Paul (1669-1739/40) ..13, 39, 45,
 48, 49, 50, 52, 54, 56
 Paul (1740-1832) 39, 42, **49**, **50**,
 80, 81, 84, 91, 92, 93, 97
 Paul (ca.1637-1707/08)39
 Paul Jr (1769-1851).... 50, 51, **84**
 Polly (1812-1882) 98, **100**
 Polly Hurlburt (1800-1861).....92
 Rachel (1768-1850).... 45, 48, **74**
 Rachel (1794-1834).....67, **68**
 Rebecca (1732-)39, **41**
 Rebecca (1816-1884)98, **100**
 Rhoda (1761-1761)13, **14**
 Rhoda (1776-1854) . 52, 53, **101**,
102, **103**
 Rhoda (1789-1859)67, **68**
 Rufus (1817-1842) 75, **79**
 Ruth (1762-1764)45, **47**
 Ruth (1765-1830) 45, 48, **72**
 Sally (1793-)59, **62**
 Sally (1801-1880)84, **87**
 Sara Elizabeth 120, **122**
 Sarah (1746-1771).... 39, 42, **54**,
 109, 110, 111
 Sarah (1774-).....13, **15**
 Sarah (1788-1858).....17, **113**
 Sarah (1794-)..... 19, 20, **116**

Sarah Elizabeth (1857-) 120, **122**
 Sarah Lovisa (1822-1914)..93, **96**
 Sarah M "Sally" (1821-) 104, **105**
 Selden (1789-) 59, **62**
 Selden Philo (1813-1900)..68, **71**
 Simeon (1742/43-1812) .. 39, 42,
52, 98, 101, 102, 103, 104, 106
 Simeon (1768-)52, **53**
 Simeon (1776-1863) . 50, 51, **91**,
92, **93**
 Simeon (1811-1897)93, **95**
 Stephen Griffith (1803-1874) .68,
70
 Susy E (ca.1858-) 120, **122**
 Theophilus (1749-1771).... 39, **42**
 Thomas (1744-)..... 39, **42**
 Timothy (-1901) 117, **119**
 Willard (-1754) 39, **42**
 Willard (1760-1838) .. 45, 47, **65**,
67, **68**
 Willard (1799-1866) 68, **69**

--Sears

Sarah (1746-1794) **52**

--Sears

Sarah (1746-1794) **53**

--Sears

Sarah (1746-1794) 98

--Sears

Sarah (1746-1794)98

--Sears

Sarah (1746-1794) 101

--Sears

Sarah (1746-1794) 102

--Sears

Sarah (1746-1794) 103

--Sears

Sarah (1746-1794) 104

--Sears

Sarah (1746-1794) 104

--Sears

Sarah (1746-1794) 106

--Sears

Sarah (1746-1794) 106

Sheldon

Benjamin (1779-1829) 56, **57**

Elisha (1737-1799) **56**, **57**

Elisha (1778-)..... 56, **57**

Samuel (1675-) 56

Samuel (1700-) 56, 57

--Sheldon

Mary (1678-).....56

Shepard

James **116**

Urban..... **62**

Shipman

Mary (1743-1837) 11, 12, 23, 24,
 27

Shufeldt

Sally (1797-)..... **62**

Shufelt

Johannes (1787-<1850)**64**
 William 64

Sizer

Lemuel (1759-)**80, 81**

Slater

Mary Ann (1798-1871)**77**

Slawter

Elizabeth (1741-1800) **50, 80, 81,**
 84, 91, 92, 93, 97

Smith

Lucy (1775-1855) **11, 12, 23, 24,**
 27, 123, 127, 132
 Mary Ann 120, 121
 Rebecca (1685-1748) .13, 39, 40,
 45, 48, 49, 50, 52, 54, 56
 Silas (1750-) ... 11, 12, 23, 24, 27
 Thomas 39

Snow

Henry**70**

Sparhawk

George 127, 128
 Mary Elizabeth (1847-1923) .**127,**
128

Sparrow

Rebecca (1655-1740) 39

Spaulding

Electa**110**

Spear

(unknown given name) 94
 Olive (1803-1878)**94**

Spencer

Louisa (1777-1844)**93**

Stilwell

Vincent (1790-1880)**62, 64**

Stokes

Edmond 99
 Melinda (1803-1835)**99**

Strong

Betsy (1781-) 69
 Mehitable (1714-)56, 57

Swazey

George Washington MD.. 132, 134
 Helen Clark**129**
 Helen Clark (1860-) **132, 134**

Taylor

Judith 99

Thompson

Samuel (1805-1886)**95**

Truesdale

Robinson (1801-1867)**87**

Tuttle

Phidelia (1813-1843)**79**

Twining

Louisa L 90

Veazey

Eleazar (1779-) 70
 Emily (1805-1879)**70**

Vitler

James (James Burt) (1791-1874)
 86

Wadsworth

Prudence 75

Watrous

Christopher (1782-1831) **62**
 Gershom 62

--Watrous

Mehetable 62

Weeks

Clotilda (1732-1808) 106, 107

West

Elizabeth (1783-) 70

Wheat

Maria (1799-1875) **78**
 William (1772-1868) 78

Wheeler

(unknown given name) **113**
 James 120, 121
 Mary E (1825-) **120, 121**

White

Ruth (1733-1823) **45, 47, 59, 60,**
 65, 67, 68, 72, 74, 75, 76

Willard

Deborah (-1721) 39
 James (-1858) **102**

Williams

Alfred **75**
 Donohue **100**

Wood

Almira **110**
 Timothy (1810-1878) **100**

Young

Sally (1802-1838) **69**